

BUREAU OF INDIAN STANDARDS

Engineering Drawing Practice for Schools & Colleges

**BUREAU OF INDIAN STANDARDS
MANAK BHAVAN, 9 BAHADUR SHAH ZAFAR MARG
NEW DELHI 110002**

SP 46 : 1988

FIRST PUBLISHED MARCH 1989

FIRST REPRINT DECEMBER 1990

SECOND REPRINT SEPTEMBER 1992

THIRD REPRINT OCTOBER 1998

© BUREAU OF INDIAN STANDARDS

UDC 744.43 : 371.623.8

ISBN 81-7061-091-2

Price Rs 275.00

PRINTED IN INDIA
AT DEE KAY PRINTERS, DELHI, 110015 ,
AND PUBLISHED BY
BUREAU OF INDIAN STANDARDS, 9 BAHADUR SHAH ZAFAR MARG, NEW DELHI 110 002

DRAWING SECTIONAL COMMITTEE, EDC 20

Chairman

DR R. VASUDEVAN

Members

SHRI F. FERNANDIS (*Alternate to
Dr R. Vasudevan*)

SHRI PRAKASH SINGH (*Alternate to
Dr R. Vasudevan*)

SHRI N. S. CHOUDHARY
SHRI J. S. SEHMI (*Alternate*)

DY DIRECTOR STANDARDS (WAGON-1)
ASSTT DIRECTOR STANDARDS
(WAGON-1) (*Alternate*)

SHRI S.K. GIRI

SHRI P. JAGADISHAN
SHRI Y.N. VERMA (*Alternate*)

SHRI M.S.S. JOIS
SHRI T.S. VENKATASHA MURTHY
(*Alternate*)

SHRI S.K. KHAN

SHRI R.M. MEGNATHAN

SHRI P.J. MEHATA

SHRI S.S. PURI

SHRI M.R. RAMAMURTHY
SHRI M.V. KANE (*Alternate*)

Representing

Bharat Heavy Electricals Ltd, Trichi

Bharat Heavy Electricals Ltd, Bhopal

Bharat Heavy Electricals Ltd, Hardwar

Instrumentation Ltd, Kota

Research, Design & Standards Organization (Ministry of Railways)

Directorate General of Employment and Training, New Delhi

Department of Atomic Energy, PPEd, Bombay

Motor Industries Co Ltd, Bangalore

Keshav Deva Malviya Institute of Petroleum Exploration (ONGC),
Dehra Dun

NGEF Ltd, Bangalore

The Institution of Engineers (India)

Directorate General of Supplies and Disposals, New Delhi

Ministry of Defence (R&D)

<i>Members</i>	<i>Representing</i>
SHRI M. RANGASHAI SHRI N.K. SRINIVAS (<i>Alternate</i>) SHRI K.R. SATHYANARAYAN (<i>Alternate</i>) SHRI T. NARASIMHA RAO (<i>Alternate</i>)	HMT Ltd, Bangalore
SHRI HANUMANTHA RAO SHRI M.A. RABINDRA (<i>Alternate</i>)	Central Machine Tool Institute, Bangalore
SHRI A.M. RAO	Engineer's India Ltd, New Delhi
SHRI A. VENKOBA RAO SHRI B.P. RAO (<i>Alternate</i>)	Hindustan Aeronautics Ltd, Bangalore
SHRI K.K. VOHRA (<i>Alternate</i>)	
SHRI R.B. SINGH SHRI S.S. JHA (<i>Alternate</i>)	Heavy Machine Building Plant, Ranchi
SHRI R.K. SINHA SHRI B.K. JHA (<i>Alternate</i>)	Project & Development India Ltd, Sindri
DR D. SWAMINATHAN	University Grants Commission, New Delhi
SHRI V. VISHWANADHAM SHRI P. KRISHNASWAMY (<i>Alternate</i>) SHRI C.S. NAIR (<i>Alternate</i>)	Tata Engineering & Locomotive Co Ltd, Jamshedpur
SHRI S. CHANDRASEKHARAN, DIRECTOR (MECH ENGG), BIS	Director General, BIS (<i>Ex-officio Member</i>)

Secretary

SHRI S.K. NAG
Joint Director (Mech Engg), BIS

PANEL FOR PREPARATION OF EDUCATIONAL MATERIAL, EDC 20:P4

<i>Convener</i>	<i>Representing</i>
SHRI PRAKASH SINGH	Bharat Heavy Electricals Ltd, Hardwar
<i>Members</i>	
SHRI R.M. MEGNATHAN	NGEF Ltd, Bangalore
SHRI M.S.S. JOIS SHRI T.S. VENKATESHA MURTHY (<i>Alternate</i>)	Motor Industries Co. Ltd, Bangalore
SHRI S. HANUMANTHA RAO	Central Machine Tool Institute, Bangalore
DR D. SWAMINATHAN	University Grants Commission, New Delhi
PROF K. VENKATARAMAN	P.S.G. College of Technology and Polytechnic, Coimbatore

CONTENTS

	PAGE
0. Foreword	v
Notes on the Use of the Document	v
Section 1 Sizes and Layout of Drawing Sheets	1
Section 2 Item References on Drawings and Item Lists	4
Section 3 Planning of Assembly Drawings	6
Section 4 Folding of Drawing Prints	8
Section 5 Scales	11
Section 6 Lines	12
Section 7 Lettering	15
Section 8 General Principles of Presentation	18
Section 9 Sections and other Conventions	21
Section 10 Conventional Representation	29
Section 11 General Principles of Dimensioning on Technical Drawings	38
Section 12 Indication of Linear and Angular Tolerancing on Technical Drawings	50
Section 13 Methods of Dimensioning and Tolerancing Cones	52
Section 14 Method of Indicating Surface Texture on Technical Drawings	56
Section 15 Technical Drawings for Structural Metal Work	63
Section 16 Symbolic Representation of Welds on Technical Drawings	71
Section 17 Drawing Practice for Isometric Projection	82
Section 18 Examples of Indication and Interpretation of Geometrical Tolerancing	86
<hr style="border: 1px solid black;"/>	
Section 19 Abbreviations	88
Appendix A Typical Examples	91
Appendix B Systems of Limits and Fits	93
Appendix C Guide for Selection of Fits	97
Appendix D General Tolerances for Linear and Angular Dimensions	103
Alphabetical Index	105
Indian Standards Referred	110

SECTION 1 SIZES AND LAYOUT OF DRAWING SHEETS

1.1 Scope – This section specifies sizes of blank and pre-printed drawing sheets for use with all technical drawings in any field of engineering.

1.2 Basic Principles – The basic principles involved in arriving at the sizes are:

(a) $x : y = 1 : \sqrt{2}$ (b) $xy = 1$

where x and y are the sides and having a surface area of 1m^2 so that $x = 0.841\text{ m}$ and $y = 1.189\text{ m}$.

1.2.1 Two series of successive format sizes are obtained by halving along the length or doubling along the width. The areas of the two sizes are in the ratio 1 : 2 (see Fig. 1.1).

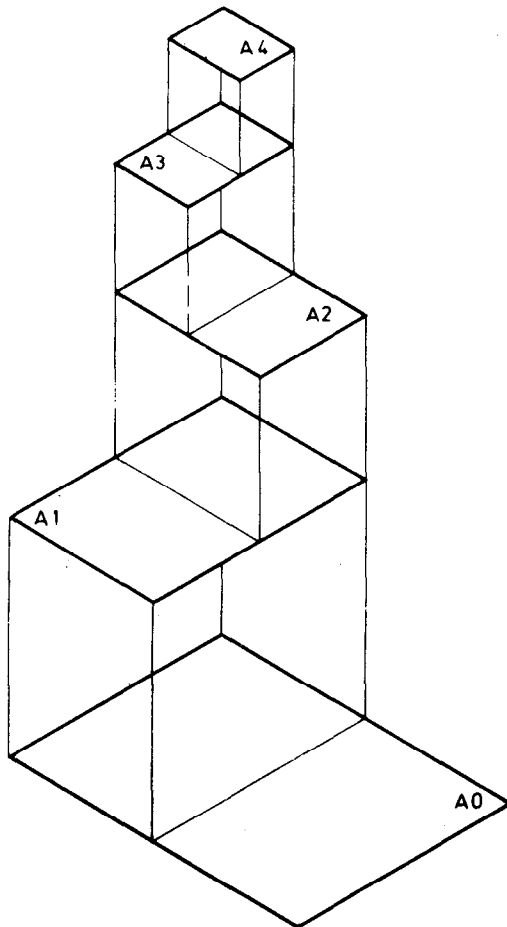


FIG. 1.1

1.2.2 The forms are similar to one another and hence the equation $x : y = 1 : \sqrt{2}$ is obtained for the two sides x and y of a format (see Fig. 1.2), consequently the ratio between both sides is the same as that of the sides of a square to its diagonal (see Fig. 1.3).

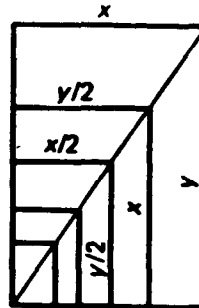


FIG.1.2 SIMILARITY OF FORMATS

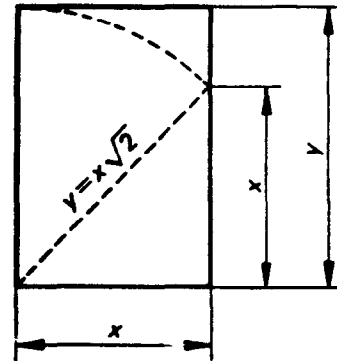


FIG. 1.3 RELATIONSHIP BETWEEN TWO SIDES

1.3 Designation of Sizes

1.3.1 Sizes Series ISO-A (First Choice) -- The preferred sizes of the trimmed sheets as selected from the main ISO-A Series are given in Table 1.1.

1.3.2 Special Elongated Sizes (Second Choice) – When a sheet of greater length is needed, one of the sizes in Table 1.2 should be used. These sizes are obtained by extending the shorter sides of a format of the ISO-A series to lengths that are multiples of the shorter sides of the chosen basic format.

TABLE 1.1

Designation	Dimensions, mm
A0	841 x 1 189
A1	594 x 841
A2	420 x 594
A3	297 x 420
A4	210 x 297

1.3.3 Exceptional Elongated Sizes (Third Choice)
When a very large or extra elongated sheet is essential, one of the size in Table 1.3 should be used. These sizes are obtained by extending the shorter sides of a format of the ISO-A series to lengths that are multiples of the shorter sides of the chosen basic format.

TABLE 1.2

Designation	Dimensions mm
A3 x 3	420 x 891
A3 x 4	420 x 1 189
A4 x 3	297 x 630
A4 x 4	297 x 841
A4 x 5	297 x 1 051

TABLE 1.3

Designation	Dimensions, mm
A0 x 2*	1 189 x 1 682
A0 x 3	1 189 x 2 523†
A1 x 3	841 x 1 783
A1 x 4	841 x 2 378†
A2 x 3	594 x 1 261
A2 x 4	594 x 1 682
A2 x 5	594 x 2 102
A3 x 5	420 x 1 486
A3 x 6	420 x 1 783
A3 x 7	420 x 2 080
A4 x 6	297 x 1 261
A4 x 7	297 x 1 471
A4 x 8	297 x 1 682
A4 x 9	297 x 1 892

* This size is equal to 2A0 of the ISO-A series.

† For practical reasons, the use of these sizes is not advisable.

1.4 Selection of Sizes - The original drawing should be made on the smallest sheet permitting the necessary clarity and resolution. The choice of sizes of the original drawing and its reproduction shall be made from the series shown in Tables 1.1, 1.2 and 1.3 in that order. Drawing sheets may be used with their longer sides positioned either horizontally (see Fig. 1.4) or vertically (see Fig. 1.5). The general features of a drawing sheet is as shown in Fig. 1.9.

1.5 Title Block

1.5.1 Position

1.5.1.1 The position of the title block should be within the drawing space (see Fig. 1.9) such that the portion of the title block containing the identification of the drawing (registration number, title, origin, etc) is situated in the bottom right-hand corner of the drawing space, both for sheets positioned horizontally (Type X) (see Fig. 1.4) or vertically (Type Y) (see Fig. 1.5). The direction of the viewing of the title block should correspond, in general, with that of the drawing.

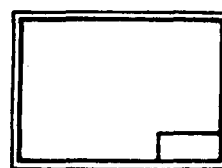


FIG. 1.4 SHEET TYPE X HORIZONTAL



FIG. 1.5 SHEET TYPE Y VERTICAL

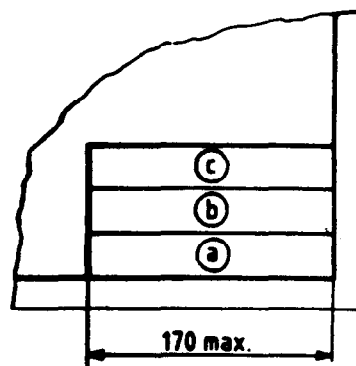


FIG. 1.6

1.5.1.2 Title block should preferably consist of one or more adjoining rectangles. These may be sub-divided into boxes for the insertion of specific information (see Fig. 1.6, 1.7 and 1.8).

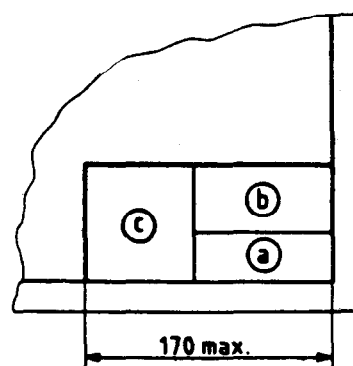


FIG. 1.7

1.6 Borders and Frames - Borders enclosed by the edges of the trimmed sheet and the frame limiting the drawing space shall be provided with all sizes. It is recommended that these borders have the minimum width of 20 mm for size A0 and A1, and a minimum width of 10 mm for size A2, A3 and A4 (see Fig. 1.9).

1.7 Centring Marks - Four centring marks shall be provided on all drawings in order to facilitate the positioning of the drawing when reproduced or microfilmed.

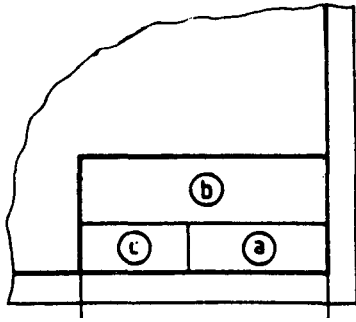


FIG. 1.8

1.8 Grid Reference

1.8.1 The provision of grid reference system is recommended for all sizes, in order to permit easy location on the drawing of details, additions, modifications, etc. The number of divisions should be divisible by two and be chosen in relation to the complexity of the drawing. It is recommended that the length of any side of the rectangles comprising

the grid shall not be less than 25 mm and not more than 75 mm.

1.8.2 The rectangles of the grid should be referred by means of capital letters along one edge and numerals along the other edge. The numbering direction may start at the sheet corner opposite to the title block and be repeated on the opposite sides.

1.9 Multiple Sheet Drawings – Multiple sheet drawings marked with the same registration or identification number should be indicated by means

example .

$$\text{Sheet No.} = n/p$$

where

n is the sheet number, and
p is the total number of sheets.

An abbreviated title block, containing only the identification zone, may be used for all sheets after the first sheet.

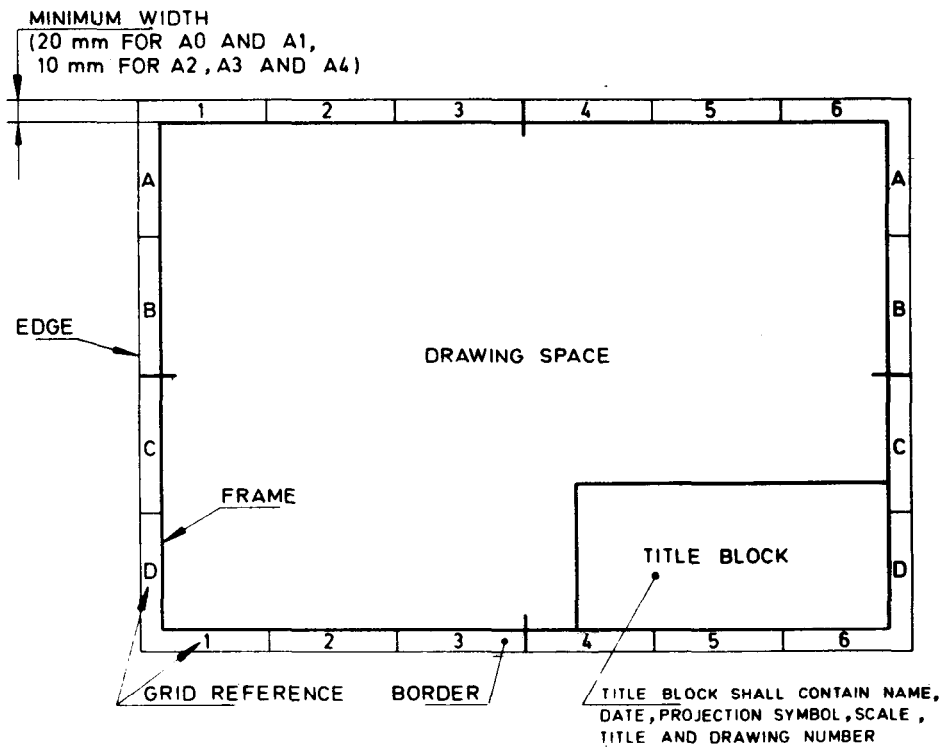


FIG. 1.9

SECTION 2 ITEM REFERENCES ON DRAWINGS AND ITEM LISTS

2.1 Scope – This section gives guidance and recommendations on establishment of item reference and item list for use with technical drawings.

2.2 Item References – The item references should be assigned in sequential order to each component part shown in an assembly and/or each detailed item on the drawing. Further identical parts shown in the same assembly should have the same item reference. All item references shall be shown in an item list (see Fig. 2.4 and Table 2.1).

2.3 Presentation

2.3.1 Item references should generally be composed of Hindu-Arabic numerals only. They may, however, be augmented by capital letters when necessary.

2.3.2 All item references on the same drawing shall be of the same type and height of lettering. They shall be clearly distinguishable from all other indications. This can be achieved, for example, by:

- a) using characters of a larger height, for example, twice the height as used for dimensioning and similar indications;
- b) encircling the characters of each item reference, in that case all such circles shall have the same diameter and to be drawn with continuous thin line (Type B) (see Fig. 2.3).
- c) combining methods (a) and (b).

2.3.3 Item references shall be placed outside the general outlines of the items concerned.

2.3.4 Each item reference should be connected to its associated item by a leader line (see Fig. 2.1, 2.2, and 2.3).

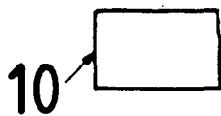


FIG. 2.1

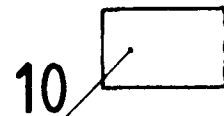


FIG. 2.2

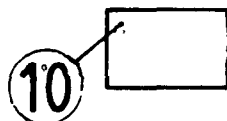


FIG. 2.3

2.3.5 Leader lines shall not intersect. They should be kept as short as practicable and generally should be drawn at an angle to the item reference. In case of encircled item references, the leader line shall be directed towards the centre of the circle.

2.3.6 Item references of related items may be shown against the same leader line (see Fig. 2.4, items 8, 9, 10 and 11).

2.3.7 Item references of identical items need only be shown once, provided there is no risk of ambiguity.

2.4 Item List

2.4.1 Item lists are complete lists of the items constituting an assembly (or a sub-assembly), or of detailed parts, presented on a technical drawing. It is not necessary for all these items to be detailed on an end-product drawing. The association between the items on an item list and their representation on the relevant drawing (or on other drawings) is given by the item references.

2.4.2 The item lists may be included on the drawing itself or be a separate document.

2.4.3 When included on the drawing, the position of the item list should be such as to be read in the viewing direction of the drawing. The list may be in conjunction with the title block. Its outlines may be drawn with continuous thick lines (type A).

2.4.4 Where the item list is shown on a separate document, this shall be identified by the same number as that of the parent drawing.

2.4.5 However, to distinguish this identification from that of the parent drawing, it is recommended that the item list number be preceded by the prefix item list (or a similar term in the language used on the documents).

2.4.6 Layout – It is recommended that the item list be arranged in columns by means of continuous thick or thin lines (type A or B) to allow information to be entered under the following headings (the sequence of these is optional):

- a) item,
- b) description,
- c) quantity,
- d) reference,
- e) material

NOTE – If necessary, more columns can be added to cover specific requirements.

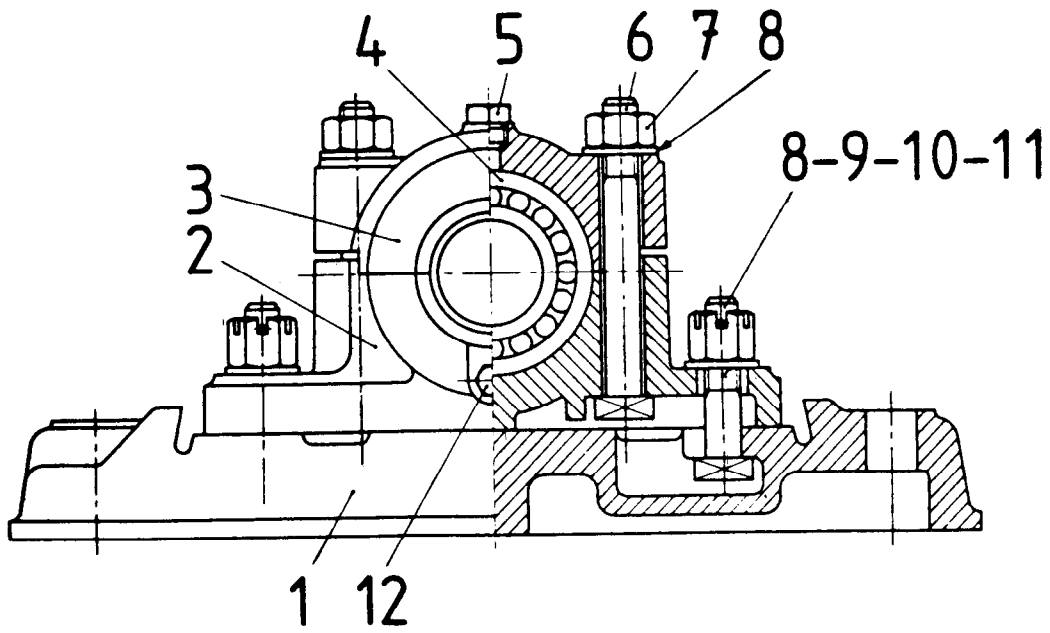


FIG. 2.4

TABLE 2.1 ITEM LIST

<i>Item</i>	<i>Quantity</i>	<i>Description</i>	<i>Reference</i>
1	1	Base	
2	1	Bottom housing	
3	1	Top housing	
4	1	Bearing	
5	1	Filling plug	
6	2	T-bolt	
7	2	Hex nut	
8	4	Washer	
9	2	T-bolt	
10	2	Castle nut	
11	2	Split pin	
12	1	Drain plug	

SECTION 3 PLANNING OF ASSEMBLY DRAWINGS

3.1 Scope – This section covers the requirements of drawing of assembly drawings.

3.3 A method, applicable to general engineering drawings and also structural drawings, etc. is described.

3.2 Where a number of drawings are required to detail a complete design, an assembly drawing is necessary. Such a drawing will show the design to a convenient scale, and the drawing or part numbers which are the constituents of the particular assembly are listed in a tabular form as shown in Fig. 2.4 and Table 2.1.

a small key plan or elevation or both, conveniently placed near the title block, indicating part of the whole work in thick lines to which the particular drawing sheet refers (see Fig. 3.1).

3.4 The general assembly drawing may be broken into further sub-assemblies and parts, determined

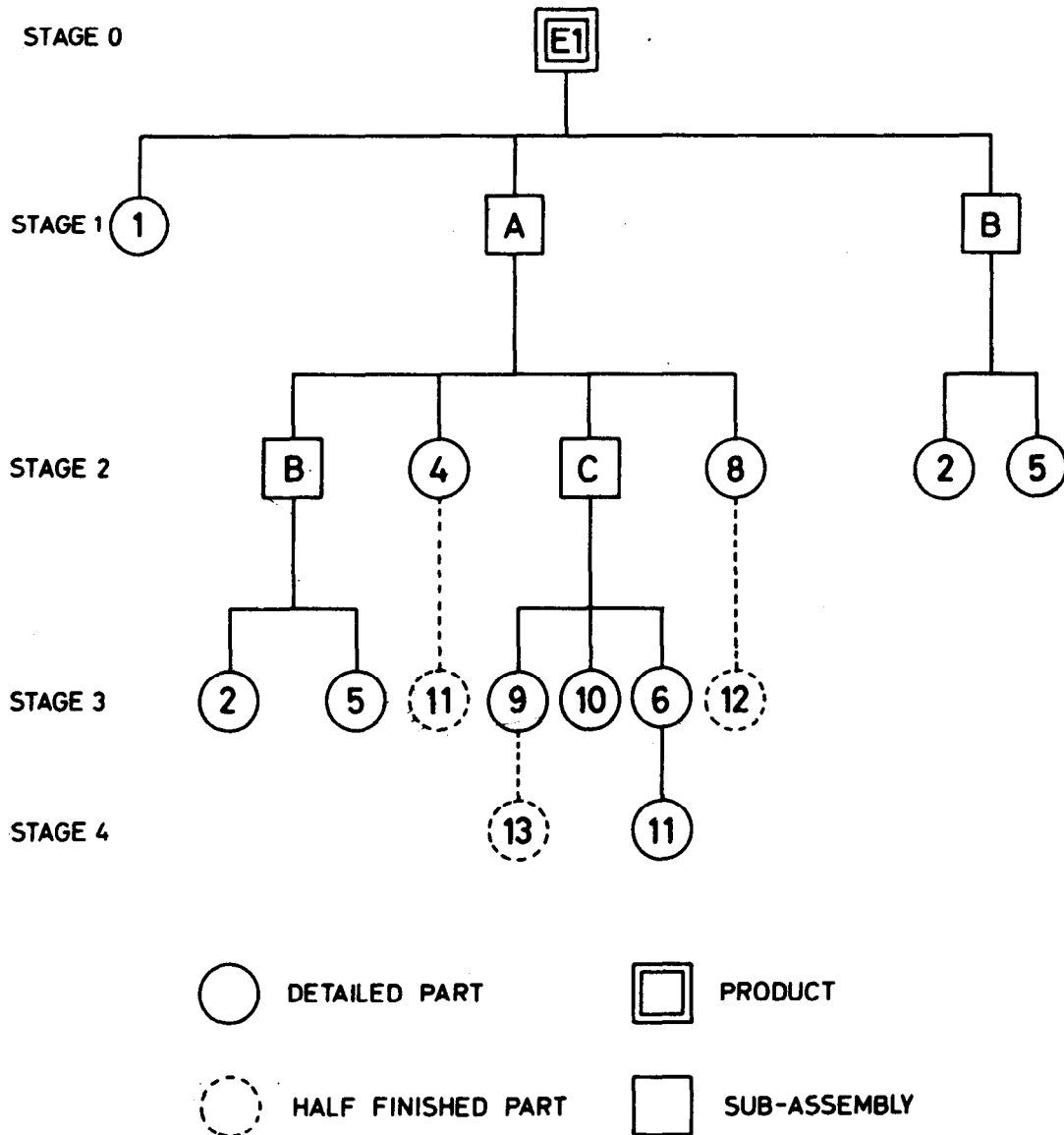
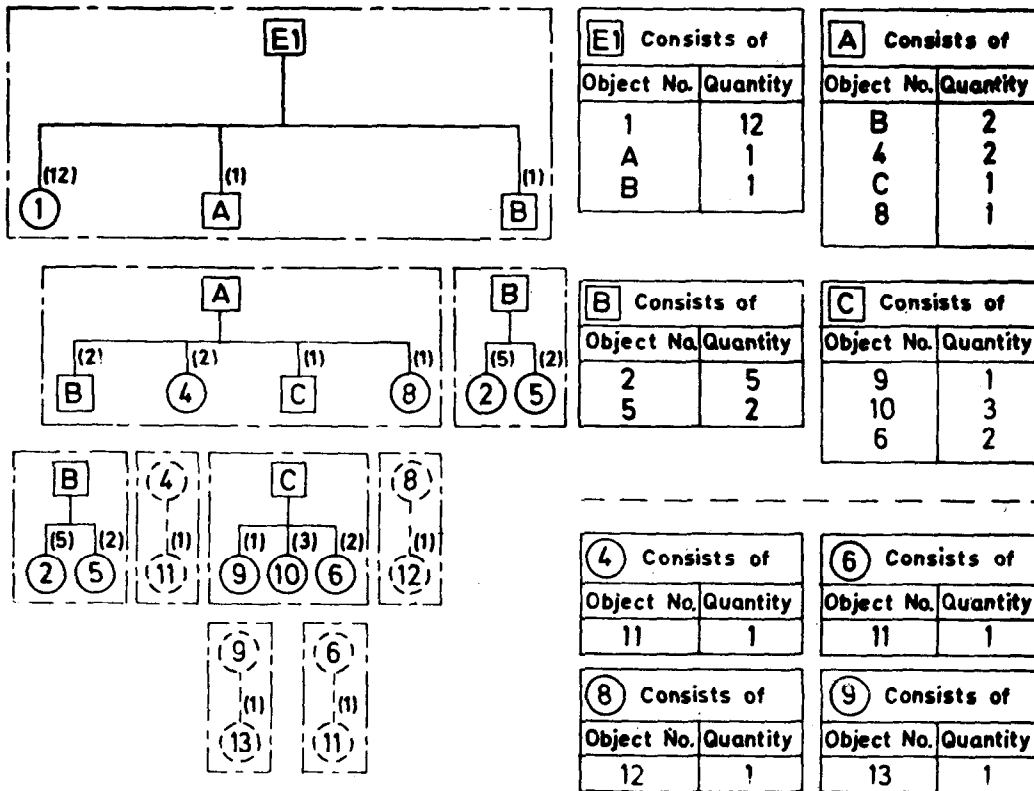


FIG. 3.1

mainly by production requirements. A typical chart showing the breakdown of such assembly drawing is shown in Fig. 3.2.

3.5 In general, the detailed view shown in any assembly drawing should have the same orientation as that shown in the main assembly view.



EXPLANATION OF SYMBOLS

- GROUP PRODUCT
- COMPOSITE PART
- ◌ SEMI-FINISHED PRODUCT
- () INDICATION OF QUANTITY IN THE PARTS LIST

FIG. 3.2

SECTION 4 FOLDING OF DRAWING PRINTS

4.1 Scope -- This section covers two methods of folding of drawing prints.

4.1.1 The first method is intended for drawing prints to be filed or bound, while the second method is intended for prints to be kept individually in filing cabinet.

4.2 Basic Principles -- The basic principles in each of the above methods are to ensure that:

- a) all large prints of sizes higher than A4 are folded to A4 sizes;

- b) the title blocks of all the folded prints appear in topmost position; and

- c) the bottom right corner shall be outermost visible section and shall have a width not less than 190 mm.

4.3 Depending on the method of folding adopted, suitable folding marks are to be introduced in the tracing sheets as guide.

4.4 Methods of Folding of Drawing Prints -- The methods recommended for folding are indicated in Fig. 4.1 and 4.2.

SHEET DESIGNATION	FOLDING DIAGRAM	LENGTHWISE FOLDING	CROSSWISE FOLDING
<p>A0 841 x 1189</p>			
<p>A1 594 x 841</p>			
<p>A2 420 x 594</p>			
<p>A3 297 x 420</p>			

All dimensions in millimetres.

FIG. 4.1 FOLDING OF PRINTS FOR FILING OR BINDING

SHEET DESIGNATION	FOLDING DIAGRAM	LENGTHWISE FOLDING	CROSSWISE FOLDING
<p>A0 841 x 1189</p>			
<p>A1 594 x 841</p>			
<p>A2 420 x 594</p>			
<p>A3 297 x 420</p>			<p>—</p>

All dimensions in millimetres.

FIG. 4.2 FOLDING OF PRINTS FOR STORING IN FILING CABINET

SECTION 5 SCALES

5.1 Scope – This section specifies recommended scales and their designation for use on all technical drawings in any field of engineering.

5.2 Definitions

5.2.1 Scale – Ratio of the linear dimension of an element of an object as represented in the original drawing to the real linear dimension of the same element of the object itself.

NOTE – The scale of a print may be different from that of the original drawing.

5.2.2 Full Size – A scale with the ratio 1:1.

5.2.3 Enlargement Scale – A scale where the ratio is larger than 1:1. It is said to be larger as its ratio increases.

5.2.4 Reduction Scale – A scale where ratio is smaller than 1:1. It is said to be smaller as its ratio decreases.

5.3 Designation – The complete designation of a scale shall consist of the word ‘SCALE’ (or its equivalent in the language used on the drawing) followed by the indication of its ratio, as follows:

- SCALE 1 : 1 for full size;
- SCALE X : 1 for enlargement scales;
- SCALE 1 : X for reduction scales.

If there is no likelihood of misunderstanding, the word SCALE may be omitted.

5.4 Scales for Use on Technical Drawings

Category	Recommended Scales		
	50:1 5:1	20:1 2:1	10:1
Enlargement Scales			
Full size			1:1
Reduction Scales	1:2	1:5	1:10
	1:20	1:50	1:100
	1:200	1:500	1:1000
	1:2000	1:5000	1:10000

5.4.1 The scale to be chosen for a drawing will depend upon the complexity of the object to be depicted and the purpose of the representation.

5.4.2 In all cases, the selected scale shall be large enough to permit easy and clear interpretation of the information depicted.

5.4.3 Details that are too small for complete dimensioning in the main representation shall be shown adjacent to the main representation in a separate detail view (or section) which is drawn to a large scale.

SECTION 6 LINES

6.1 Scope – This section specifies the types of lines, their thickness and application for use in technical drawings.

6.2 Types of Lines

6.2.1 The types of lines and their applications are as given in Table 6.1.

6.2.1.1 It is recommended that only line types as given in Table 6.1 shall be used.

6.2.1.2 Where other types or thicknesses of lines are used for special fields or if the lines specified in Table 6.1 are used for applications other than those detailed in the table, the conventions adopted should be explained by notes on the respective drawing.

6.2.1.3 Typical applications of different types of lines are shown in Fig. 6.1 and 6.2.

6.3 Thicknesses and Proportional Dimensions of Lines

6.3.1 Two thicknesses of lines are used. The ratio of the thick to the thin line shall not be less than 2:1. Grading of lines is in $\sqrt{2}$ increments.





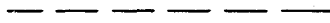
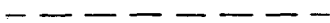
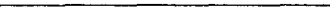
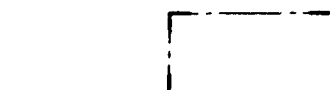

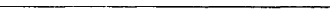
The thickness of lines should be chosen according to the size and the type of the drawing from the following range:

0.18, 0.25, 0.35, 0.5, 0.7, 1, 1.4 and 2 mm.

6.3.2 For all views of one piece to the same scale, the thickness of the lines should be the same.

NOTE – Owing to difficulties in certain methods of reproduction, the line thickness of 0.18 mm should be avoided.

TABLE 6.1

Line	Description	General applications See figures 6.1, 6.2 and other relevant figures
A 	Continuous thick	A1 Visible outlines A2 Visible edges
B 	Continuous thin (straight or curved)	B1 Imaginary lines of intersection B2 Dimension lines B3 Projection lines B4 Leader lines B5 Hatching B6 Outlines of revolved sections in place B7 Short centre lines
C 	Continuous thin freehand ²⁾	C1 Limits of partial or interrupted views and sections, if the limit is not a chain thin
D ¹⁾ 	Continuous thin (straight) with zigzags	D1 line (see figures 53 and 54)
E 	Dashed thick ²⁾	E1 Hidden outlines E2 Hidden edges
F 	Dashed thin	F1 Hidden outlines F2 Hidden edges
G 	Chain thin	G1 Centre lines G2 Lines of symmetry G3 Trajectories
H 	Chain thin, thick at ends and changes of direction	H1 Cutting planes
J 	Chain thick	J1 Indication of lines or surfaces to which a special requirement applies
K 	Chain thin double-dashed	K1 Outlines of adjacent parts K2 Alternative and extreme positions of movable parts K3 Centroidal lines K4 Initial outlines prior to forming (see figure 58)
		(see figure 48)

1) This type of line is suited for production of drawings by machines.

2) Although two alternatives are available, it is recommended that on any one drawing, only one type of line be used.

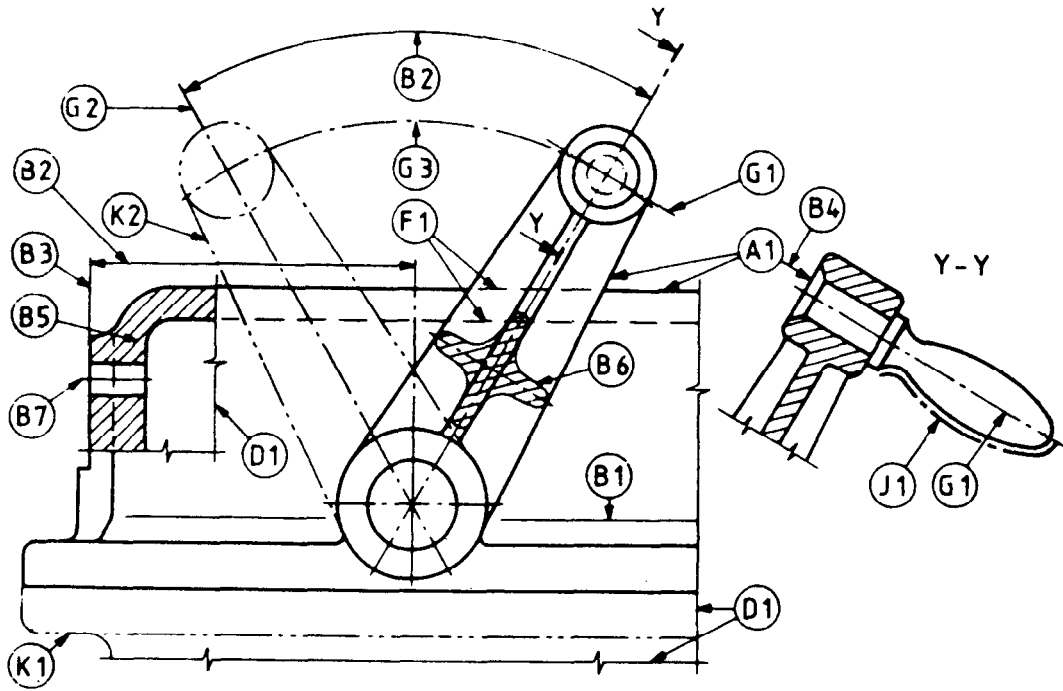


FIG. 6.1

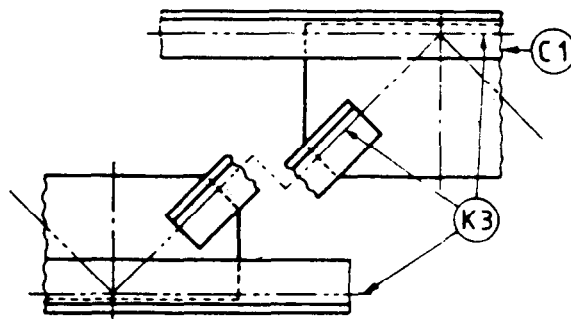


FIG. 6.2

6.4 Spacing of Lines – The minimum space between parallel lines, including hatching, should never be less than twice the thickness of the heaviest line. It is recommended that these spaces should never be less than 0.7 mm.

6.5 Order of Priority of Coinciding Lines – When two or more lines of different type coincide, the following order of priority should be observed (see Fig. 6.3).

- a) visible outlines and edges (continuous thick lines, type A);
- b) hidden outlines and edges (dashed line, type E or F);
- c) cutting planes (chain thin line, thick at ends and changes of cutting planes, type H);
- d) centre lines and lines of symmetry (chain thin line, type G);
- e) centroidal lines (chain thin double-dashed line, type K);
- f) projection lines (continuous thin line, type B).

Adjacent outlines of assembled parts shall coincide, black thin sections excepted (see Fig. 9.9).

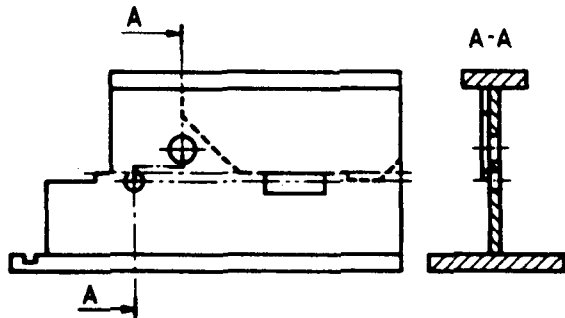


FIG. 6.3

6.6 Termination of Leader Lines – A leader line is a line referring to a feature (dimension, object, outline, etc).

Leader lines should terminate:

- with a dot, if they end within outlines of an object (see Fig. 6.4).
- with an arrow head, if they end on the outline of an object (see Fig. 6.5).
- without dot or arrowhead, if they end on a dimension line (see Fig. 6.6).

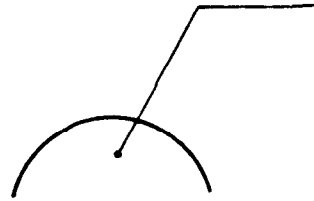


FIG. 6.4

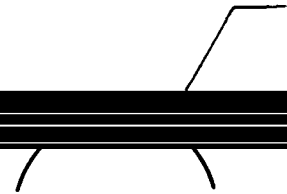


FIG. 6.5

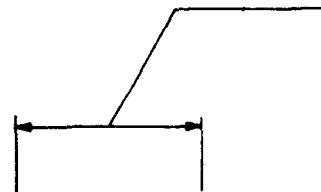


FIG. 6.6

SECTION 7 LETTERING

7.1 Scope – This section specifies the characteristics of lettering used on technical drawings, and associated documents. It concerns primarily letters written with the aid of stencils, but is equally applicable for free hand lettering.

7.2 Dimensions

7.2.1 The height h of the capital letter is taken as the base of dimensioning (see Tables 7.1 and 7.2).

7.2.2 The two standard ratios for d/h , 1/14 and 1/10, are most economical as they result in a

minimum number of line thickness as is illustrated in Tables 7.1 and 7.2.

7.2.2.1 Recommended ratios for the height of lower-case letters (without stem or tail), for the space between characters, for the minimum space of the base lines and the minimum space of words are given in Tables 7.1 and 7.2.

7.3 The lettering may be inclined 15° to the right, or may be vertical.

7.4 Recommended Sizes

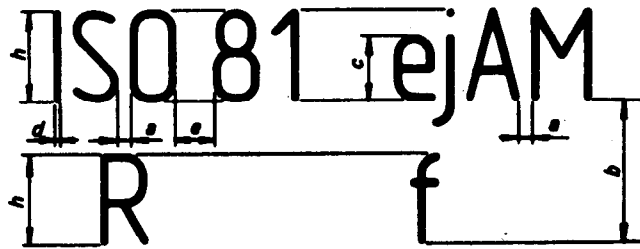


FIG. 7.1

TABLE 7.1

Lettering A ($d = h/14$)

Values in millimetres

Characteristic	Ratio	Dimensions							
		2.5	3.5	5	7	10	14	20	28
Lettering height	h	(14/14) h							
Height of capitals									
Height of lower-case letters (without stem or tail)	c	(10/14) h	–	2.5	3.5	5	7	10	14
Spacing between characters	e	(2/14) h	0.35	0.5	0.7	1	1.4	2	2.8
Minimum spacing of base lines	b	(20/14) h	3.5	5	7	10	14	20	28
Minimum spacing between words	e	(6/14) h	1.05	1.5	2.1	3	4.2	6	8.4
Thickness of lines	d	(1/14) h	0.18	0.25	0.35	0.5	0.7	1	1.4

NOTE – The spacing e between two characters may be reduced by half if this gives a better visual effect, as for example LA, TV; it then equals the line thickness d .

TABLE 7.2

Lettering B ($d = h/10$)

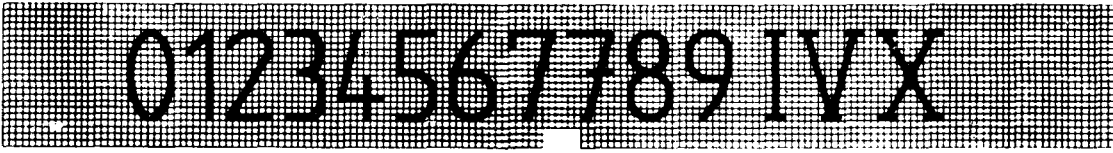
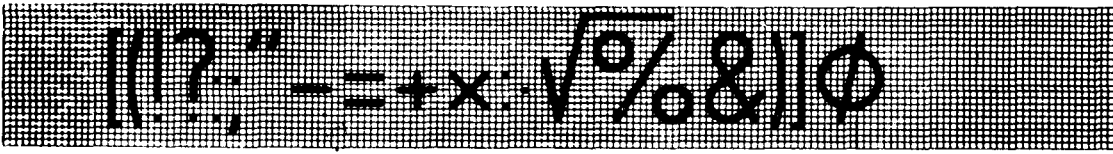
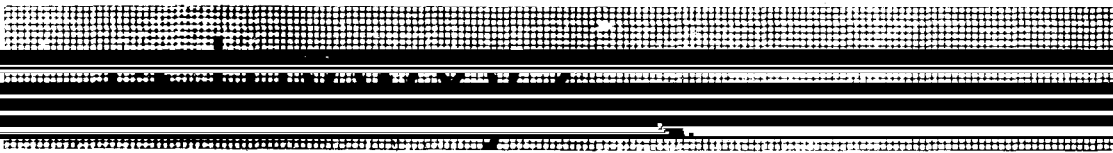
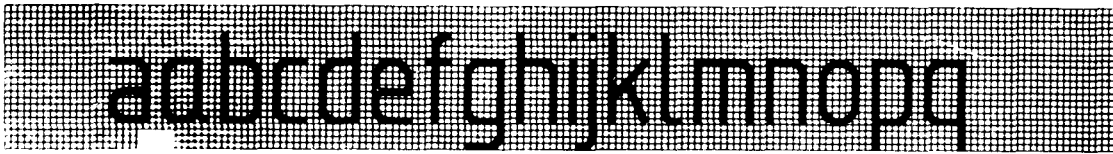
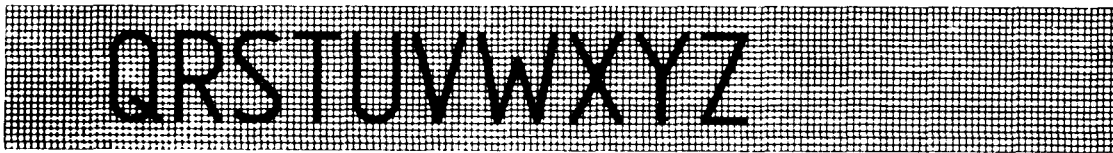
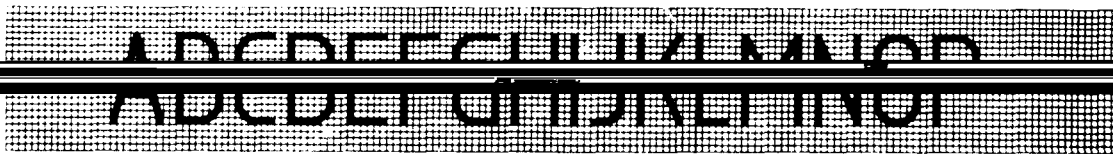
Values in millimetres

Characteristic	Ratio	Dimensions							
		2.5	3.5	5	7	10	14	20	
Lettering height	h	(10/10) h	2.5	3.5	5	7	10	14	20
Height of capitals	h	(10/10) h	2.5	3.5	5	7	10	14	20
Height of lower-case letters (without stem or tail)	c	(7/10) h	—	2.5	3.5	5	7	10	14
Spacing between characters	a	(2/10) h	0.5	0.7	1	1.4	2	2.8	4
Minimum spacing of base lines	b	(14/10) h	3.5	5	7	10	14	20	28
Minimum spacing between words	e	(6/10) h	1.5	2.1	3	4.2	6	8.4	12
Thickness of lines	d	(1/10) h	0.25	0.35	0.5	0.7	1	1.4	2

NOTE — The spacing a between two characters may be reduced by half if this gives a better visual effect, as for example LA, TV; it then equals the line thickness d .

7.5 Specimen

7.5.1 Lettering A Vertical



NOTE — To obtain constant line-density, freedom from blotting at intersecting line and ease of writing, the letters shall be formed so that lines cross or meet nearly at right-angles.

7.5.2 Lettering B Vertical

A B C D E F G H I J K L M N O P

Q R S T U V W X Y Z

a b c d e f g h i j k l m n o p q

r s t u v w x y z

[(! ? , ; " ' - = + x : √ ° % &)] φ

U I Z 3 4 5 0 1 7 0 9 1 V A

NOTE - To obtain constant line-density, freedom from blotting at intersecting line and ease of writing, the letters shall be formed so that lines cross or meet nearly at right-angles.

SECTION 8 GENERAL PRINCIPLES OF PRESENTATION

8.1 Scope – This section specifies the general principles of presentation of technical drawings following the orthographic projection methods.

8.1.1 This section is intended for all kinds of technical drawings (mechanical, electrical, architectural, civil engineering, etc). However, it is recognized that in some specific technical areas, the general rules and conventions cannot adequately cover all the needs of specialized practices, and that additional rules are required which may be specified in separate standards. For these areas, the general principles should however be respected in order to facilitate international exchange of drawings and to ensure the coherence of drawings in a comprehensive system relating to several technical functions.

8.2 Views

8.2.1 Designation of Views

View in direction *a* = View from the front

View in direction *b* = View from above

View in direction *c* = View from the left

View in direction *d* = View from the right

View in direction *e* = View from below

View in direction *f* = View from the rear

8.2.1.1 The front view (principle view) having been chosen (see 8.2.4), the other customary views make with it and between themselves angles of 90° or multiples of 90° (see Fig. 8.1).

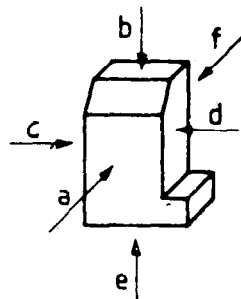


FIG. 8.1

8.2.2 Relative Position of Views – Two alternative orthographic projection methods, of equal standing, can be used.

- the first angle projection method, or
- the third angle projection method.

NOTE – For uniformity among the figures given throughout this publication as examples, the relative position of views are those provided by the first angle projection method. It should be understood, however, that each of the two methods could equally have been used without prejudice to the principles established. However, as a basic requirement, use of first angle projection method is to be followed.

8.2.2.1 First angle projection method – With reference to the front view (a), the other views are arranged as follows (see Fig. 8.2):

The view from above (b), is placed underneath. The view from below (e), is placed above, The view from the left (c), is placed on the right. The view from the right (d), is placed on the left. The view from the rear (f) may be placed on the left, or on the right, as convenient.

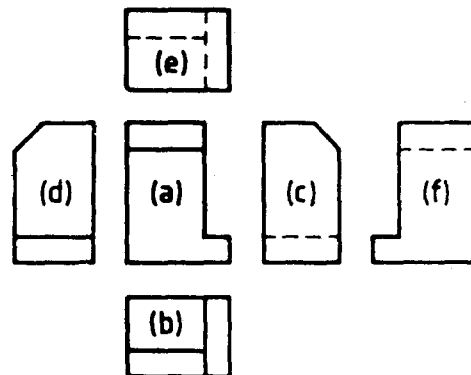


FIG. 8.2

The distinguishing symbol of this method is shown in Fig. 8.3.



FIG. 8.3

8.2.2.2 Third angle projection method – With reference to the front view (a), the other views are arranged as follows (see Fig. 8.4):

The view from above (b), is placed above.
 The view from below (e), is place underneath.
 The view from the left (c), is placed on the left.
 The view from the right (d), is placed on the right.
 The view from the rear (f), may be placed on the left, or on the right, as convenient.

The distinguishing symbol of this method is shown in Fig. 8.5.

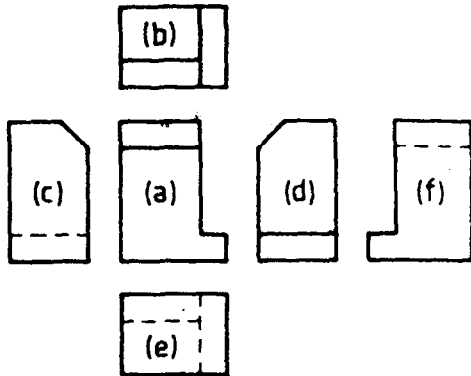


FIG. 8.4



FIG. 8.5

8.2.2.3 Layout of Views Using Reference Arrows – In those cases where it is an advantage to position the views not according to the strict pattern of the first or the third angle projection methods, the use of reference arrows permits the various views to be freely positioned.

With the exception of the principal view, each view shall be identified by a capital letter which is repeated near the arrow needed to indicate the direction of viewing for the relevant view.

The designated views may be located irrespective of the principal view. The capital letters identifying the referenced views shall be placed either immediately below or above the relevant views. In any one drawing, the references shall be placed in the same way. No other indication is necessary (see Fig. 8.6).

8.2.3 Indication of Method – Where one of the methods specified in 8.2.2.1 and 8.2.2.2 is being used, the said method must be indicated on the drawing by means of its distinguishing symbol as shown in Fig. 8.3 or 8.5.

The symbol shall be placed in a space provided for the purpose in the title block of the drawing.

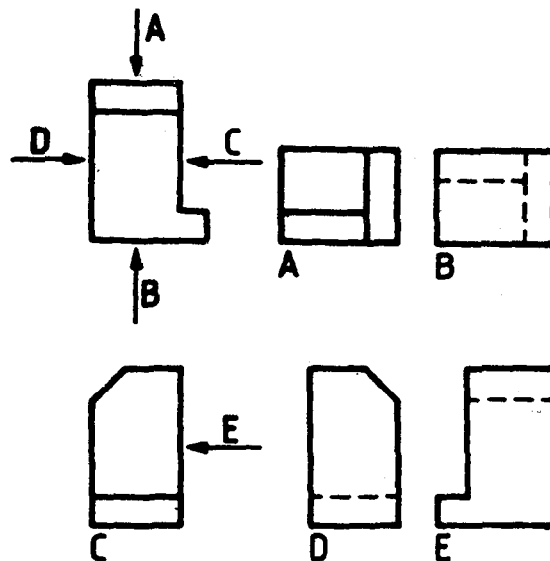


FIG. 8.6

For the layout of views using reference arrows specified in 8.2.2.3, no distinguishing symbol is required.

8.2.4 Choice of Views

8.2.4.1 The most informative view of an object shall be used as the front or principal view. Generally, this view shows the part in the functioning position. Parts which can be used in any position should preferably be drawn in the main position of manufacturing or mounting.

8.2.4.2 When other views (including sections) are needed, these shall be selected according to the following principles:

- to limit the number of views and sections to the minimum necessary and sufficient to fully delineate the object without ambiguity,
- to avoid the need for hidden outlines and edges,
- to avoid unnecessary repetition of detail.

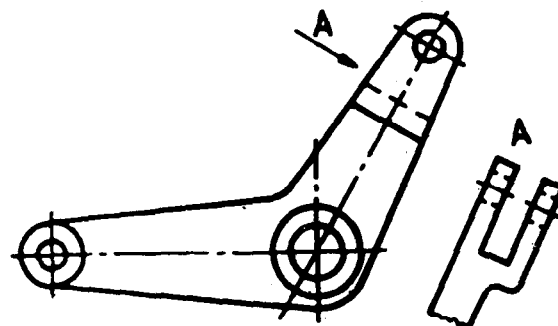


FIG. 8.7

8.2.5 *Special Views*

8.2.5.1 If a direction of viewing different from those shown in 8.2.1 is necessary, or if a view cannot be placed in its correct position using the methods shown in 8.2.2.1 and 8.2.2.2, reference arrows as indicated in 8.2.2.3 shall be used for the relevant view (see Fig. 8.7 and 8.8).

8.2.5.2 Whatever the direction of viewing, the capital letters referencing the views shall always be positioned normal to the direction of reading.

8.2.6 *Partial Views* – Partial views may be used where complete views would not improve the information to be given. The partial view shall be cut off by a continuous thin freehand line (type C) or

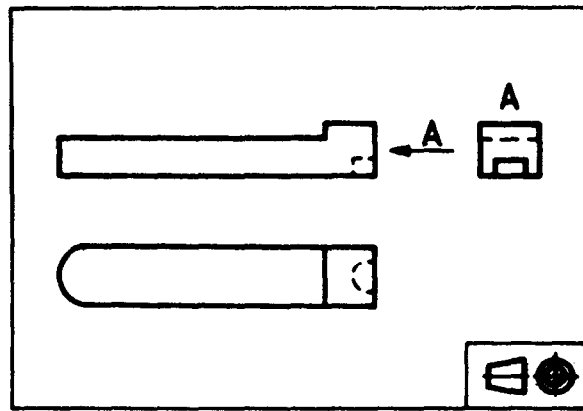


FIG. 8.8

8.2.7 *Local Views*

8.2.7.1 Provided that the presentation is unambiguous, it is permitted to give a local view instead of a complete view for symmetrical items. The local view should be drawn in third angle projection,

execution of the drawing.

8.2.7.2 Local views shall be drawn with continuous thick lines (type A), and shall be connected to the principal view by a centre line (type G). Examples of local views are shown in the Fig. 9.27, 9.28, 9.29 and 9.30.

SECTION 9 SECTIONS AND OTHER CONVENTIONS

9.1 Scope — This section covers the methods of representation of sectional views and other conventions.

9.2 Sections

9.2.1 Notes on Hatching of Sections

9.2.1.1 Hatching is generally used to show areas of sections. Allowance must be made for the methods of reproduction that are to be used.

9.2.1.2 The simplest form of hatching is usually adequate for the purpose, and may be based upon continuous thin lines (type B) at a convenient angle, preferably 45°, to the principal outlines or lines of symmetry of the sections (see Fig. 9.1, 9.2 and 9.3).

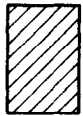


FIG. 9.1

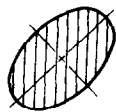


FIG. 9.2

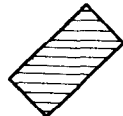


FIG. 9.3

9.2.1.3 Separate areas of a section of the same component shall be hatched in an identical manner. The hatching of adjacent components shall be carried out with different directions or spacings (see Fig. 9.4 and 9.5).

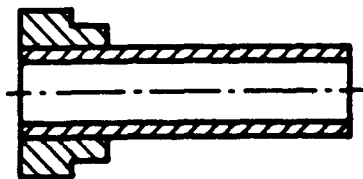


FIG. 9.4

9.2.1.4 Spacing between the hatching lines should be chosen in proportion to the size of the hatched areas, provided that the requirement for minimum spacing are maintained (see 6.4).

9.2.1.5 In the case of large areas, the hatching may be limited to a zone following the contour of the hatched area (see Fig. 9.5).

9.2.1.6 Where sections of the same part in parallel planes are shown side by side, the hatching shall be identical, but may be offset along the

dividing line between the sections if greater clarity is considered necessary (see Fig. 9.6).

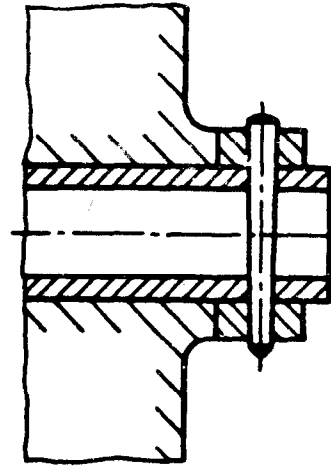


FIG. 9.5

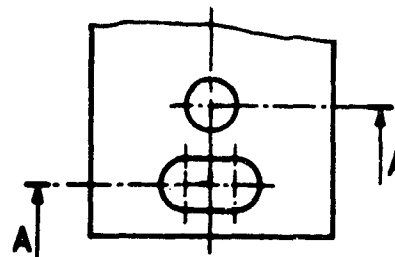
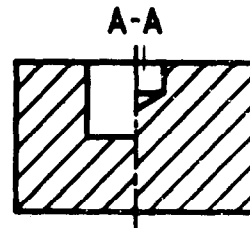


FIG. 9.6

9.2.1.7 Hatching shall be interrupted when it is not possible to place inscriptions outside the hatched area (see Fig. 9.7).

9.2.2 Hatching to Indicate Type of Materials

9.2.2.1 Hatching may be used to indicate type of materials in sections.

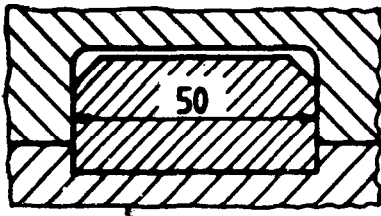


FIG. 9.7

9.2.2.2 If different types of hatching are used to indicate different materials, the meaning of these hatchings shall be clearly defined on the drawing, or by reference to appropriate standards.

9.2.3 *Thin Sections* – Thin sections may be shown entirely black (see Fig. 9.8); a space of not less than 0.7 mm must be left between adjacent sections of this type (see Fig. 9.9).



FIG. 9.8



FIG. 9.9

9.2.4 *Notes on Sections*

9.2.4.1 The general rules for the arrangement of views (see 8.2.2) apply equally when drawing sections.

9.2.4.2 Where the location of a single cutting plane is obvious, no indication of its position or identification is required (see Fig. 9.10 and 9.21).

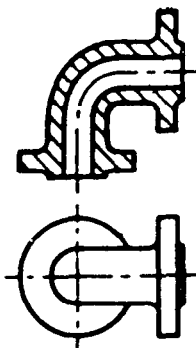


FIG. 9.10

9.2.4.3 Where the location is not obvious, or where it is necessary to distinguish between several cutting planes (see Fig. 9.11 to 9.15), the position of the cutting plane(s) shall be indicated by means of a

thin chain line, thick at ends and changes of direction (type H). The cutting plane should be identified by designations, for example capital letters, and the direction of viewing should be indicated by arrows. The section should be indicated by the relevant designations (see Fig. 9.11 to 9.15).

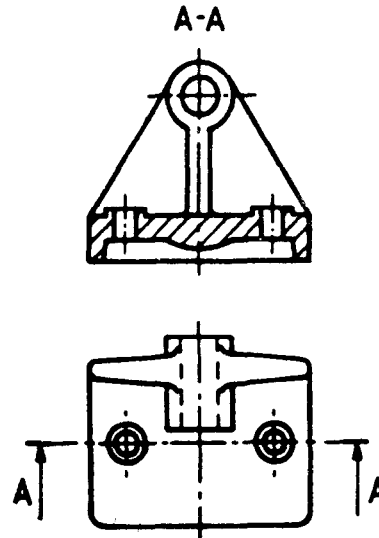


FIG. 9.11

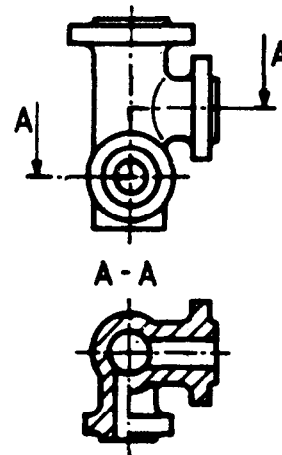


FIG. 9.12

9.2.4.4 The designations on the referenced sections shall be placed either immediately below or above the relevant sections, but in any one drawing the references shall be placed in the same way. No other indication is necessary.

9.2.4.5 In certain cases, the parts located beyond the cutting plane need not be drawn completely.

9.2.4.6 In principle, ribs, fasteners, shafts, spokes of wheels, and the like are not cut in the longitudinal sections, and therefore should not be hatched (see Fig. 9.14 and 9.15).

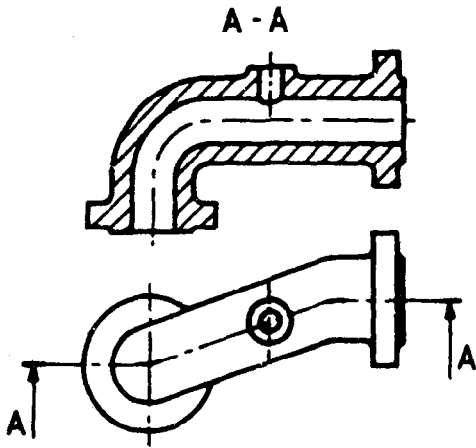


FIG. 9.13

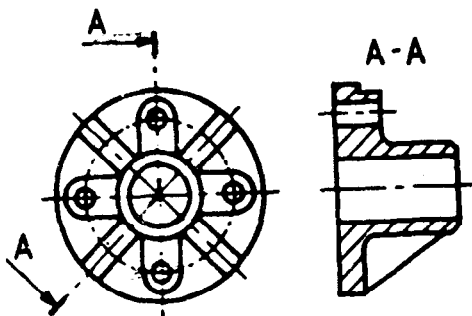


FIG. 9.14

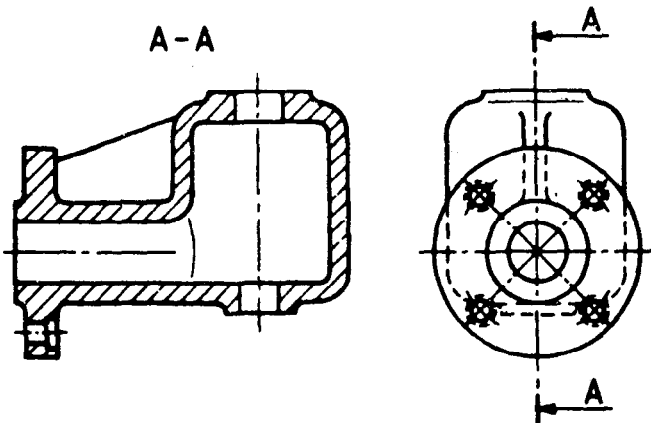


FIG. 9.15

9.2.5 Cutting Planes (Examples)

9.2.5.1 Section in one plane (see Fig. 9.10 and 9.11);

9.2.5.2 Section in two parallel planes (see Fig. 9.12);

9.2.5.3 Section in three contiguous planes (see Fig. 9.13):

9.2.5.4 Section in two intersecting planes, one shown revolved into the plane of projection (see Fig. 9.14):

9.2.5.5 In the case of parts of revolution containing regularly spaced details that require to be shown in section, but are not situated in the cutting plane, provided that no ambiguity can arise, such details may be depicted by rotating them into the cutting plane (see Fig. 9.15) but some indication of having done so is recommended.

9.2.6 Sections Revolved in the Relevant View or Removed Sections

9.2.6.1 Cross-sections may be revolved in the relevant view or removed.

9.2.6.2 When revolved in the relevant view, the outline of the section shall be drawn with continuous thin lines (type B) and further identification is not necessary (see Fig. 9.16).

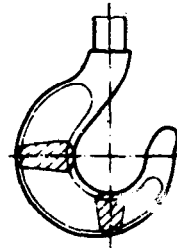


FIG. 9.16

9.2.6.3 When removed, the outline of the section shall be drawn with continuous thick lines (type A). The removed section may be placed:

- either near to and connected with the view by a chain thin line (type G) (see Fig. 9.17 A).
- or in a different position and identified in the conventional manner as in 9.2.4 by designation (see Fig. 9.17 B).

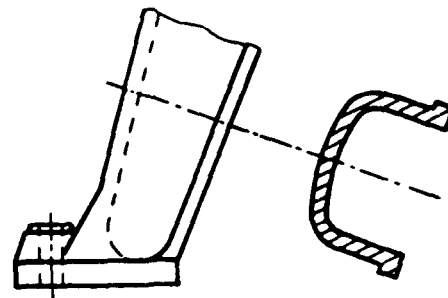


FIG. 9.17 A

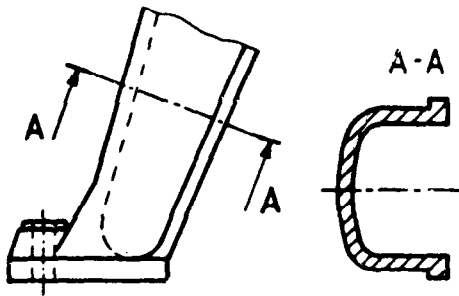


FIG. 9.17 B

9.2.7 *Half Sections* – Symmetrical parts may be drawn half in full view and half in section (see Fig. 9.18).

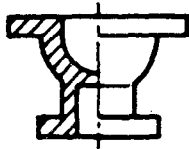


FIG. 9.18

9.2.8 *Local Section* – A local section may be drawn if a complete or half section is not convenient. The local break can be shown by either a continuous thin freehand line (type C) (see Fig. 9.19) or by continuous thin straight line with zigzag (type D) (see Fig. 6.1).

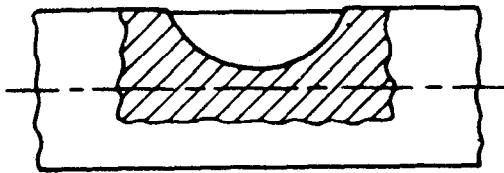


FIG. 9.19

9.2.9 *Arrangement of Successive Sections* – Successive sections may be arranged in a manner similar to the examples shown in Fig. 9.20, 9.21 and 9.22 as convenient for the layout and understanding of the drawing.

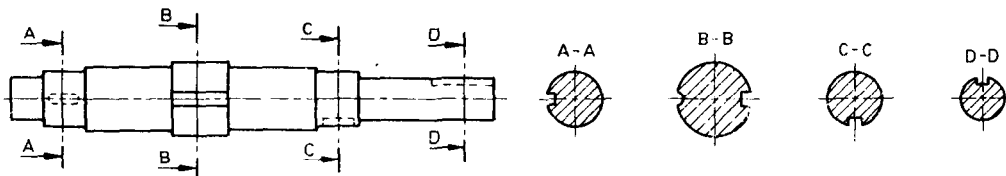


FIG. 9.20

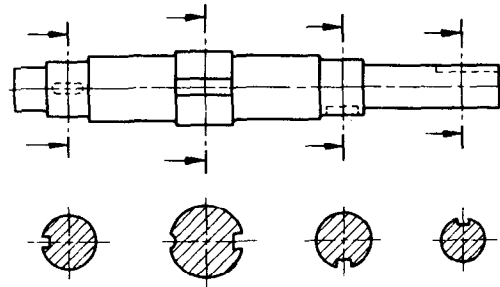


FIG. 9.21

9.3 Other Conventions

9.3.1 *Adjacent Parts* – Where their representation is necessary, parts adjacent to an object shall be drawn with chain thin double dashed lines (type K). The adjacent part shall not hide the principal part, but may be hidden by the latter (see Fig. 9.23).

Adjacent parts in sections shall not be hatched.

9.3.2 Intersections

9.3.2.1 *True intersections* – True geometric intersection lines shall be drawn with continuous thick lines (type A) when visible, or with dashed lines (type E or F) when hidden (see Fig. 9.24).

9.3.2.2 *Imaginary intersections* – Imaginary intersection lines (such as fillets or rounded corners) may be indicated in a view by means of continuous thin lines (type B), not touching the outlines (see Fig. 9.25).

9.3.2.3 *Simplified representation of intersections* – Simplified representations of true geometric or imaginary intersection lines may be applied at intersections:

- a) between two cylinders : the curved lines of intersection are replaced by straight lines (see Fig. 9.26, 9.27 and 9.29).
- b) between a cylinder and a rectangular prism: the displacement of the straight line of intersection is omitted (see Fig. 9.28 and 9.30).

As the difference in size between the intersecting parts increases, the simplified representation (see

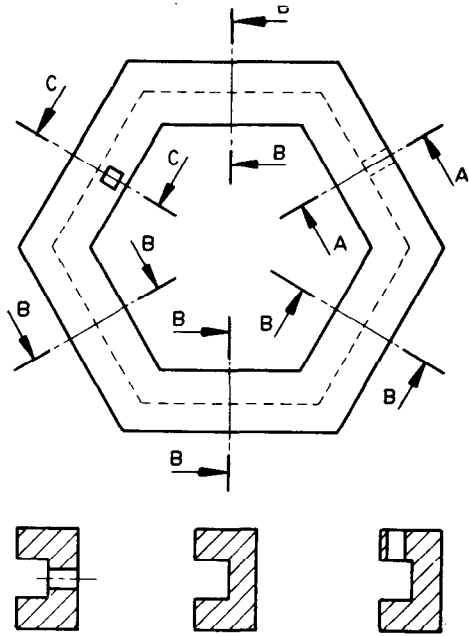


FIG. 9.22

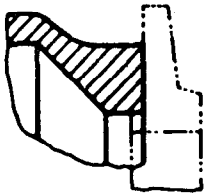


FIG. 9.23

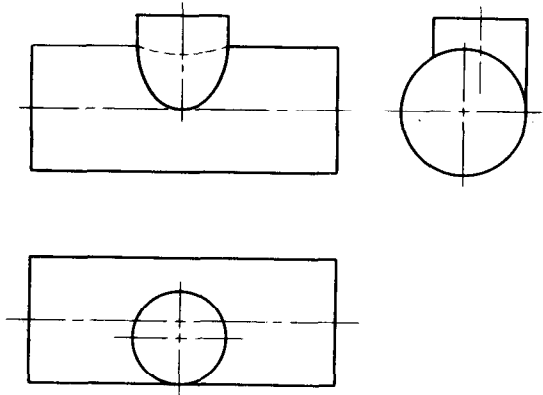


FIG. 9.24

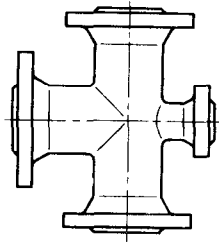


FIG. 9.25

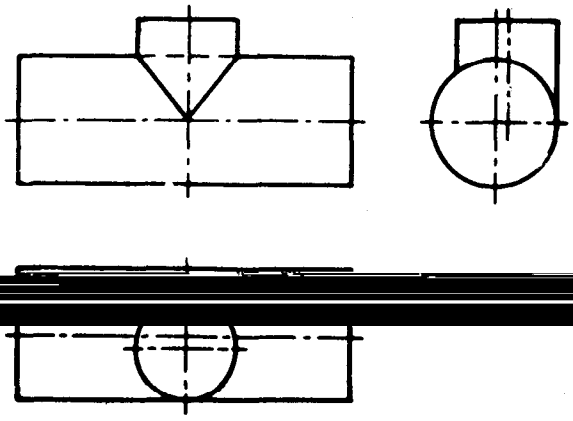


FIG. 9.26

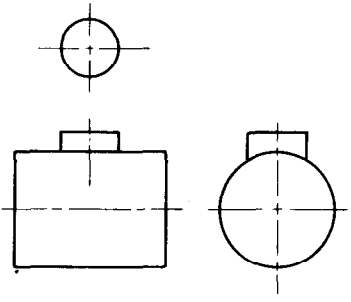


FIG. 9.27

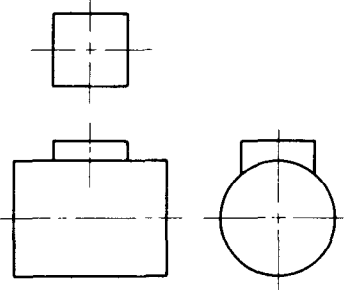


FIG. 9.28

Fig. 9.26 to 9.30) only gives a better approach to a real intersection, provided that the axes of the intersecting parts are both mutually perpendicular and intersect, or nearly so.

NOTE - This simplified representation should be avoided if it affect the comprehensibility of the drawing.

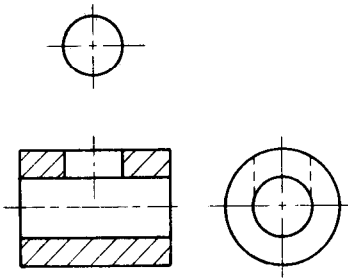


FIG 9.29

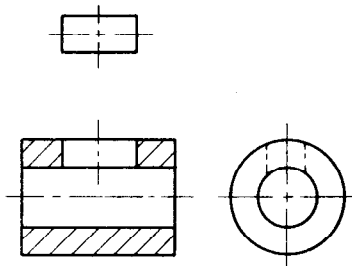


FIG. 9.30

9.3.3.2 Square and rectangular openings – In order to indicate an opening in a flat part in frontal view, without aid of additional sections, this opening may be shown by drawing its diagonals in continuous thin lines (type B) (see Fig. 9.33).

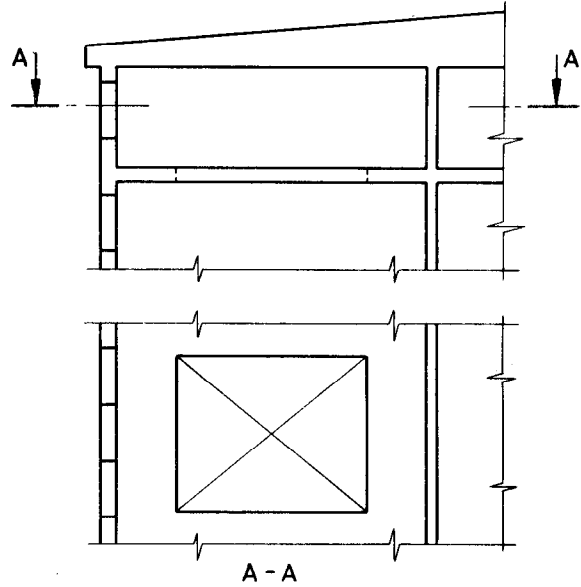


FIG. 9.33

9.3.3 Conventional Representation of Square Ends and Openings

9.3.3.1 Square ends on shafts – In order to avoid drawing a supplementary view or section, square ends (see Fig. 9.31) or tapered square ends on shafts (see Fig. 9.32) may be indicated by diagonals

9.3.4 Parts Located in Front of a Cutting Plane – If, it is necessary to indicate parts located in front of the cutting plane, these parts are to be represented by chain thin double dashed lines (type K) (see Fig. 9.34).

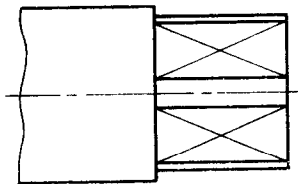


FIG. 9.31

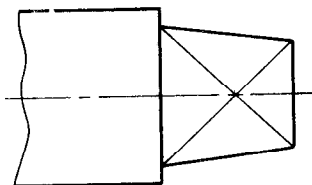


FIG. 9.32

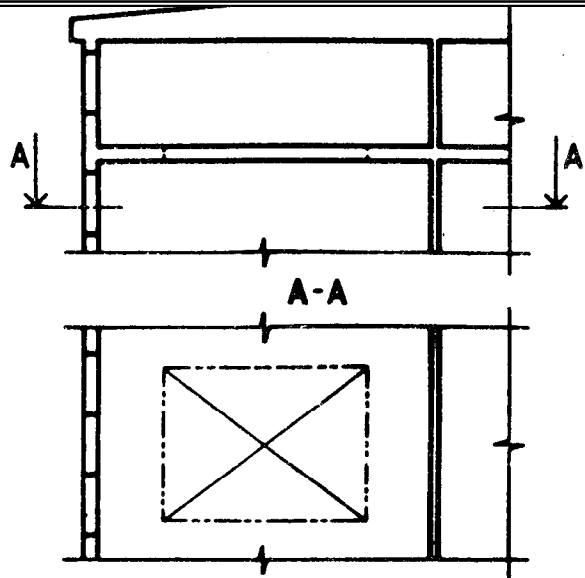


FIG. 9.34

9.3.5 Views of Symmetrical Parts

9.3.5.1 To save time and space, symmetrical objects may be drawn as a fraction of the whole (see Fig. 9.35 to 9.38).

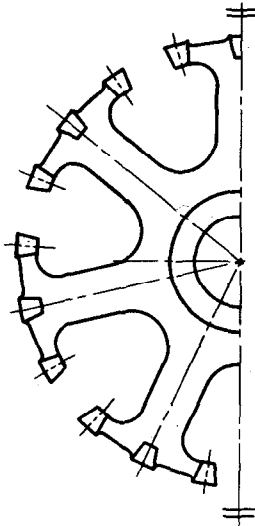


FIG. 9.35

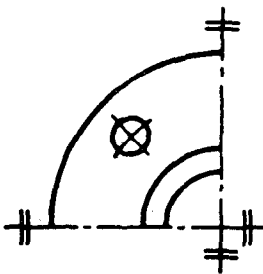


FIG. 9.36

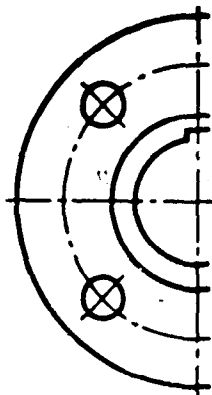


FIG. 9.37

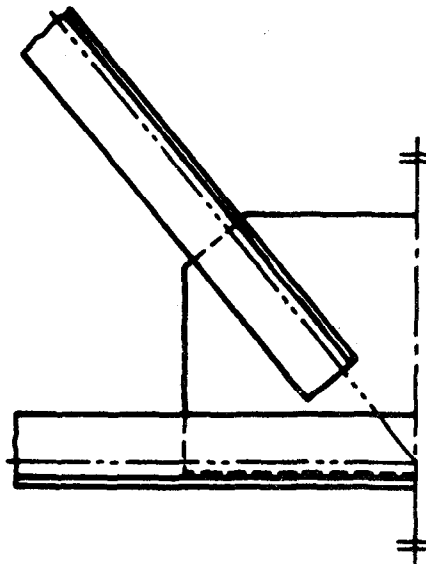


FIG. 9.38

9.3.5.2 The line of symmetry is identified at its ends by two thin short parallel lines drawn at right angles to it (see Fig. 9.35, 9.36 and 9.38).

Another method is to show the lines representing the object extending a little beyond the line of symmetry (see Fig. 9.37). In this case, the short parallel lines may be omitted.

NOTE – In the application of this practice, it is essential that due care is taken to avoid loss of understanding of the drawing.

9.3.6 Interrupted Views – In order to save space, it is permissible to show only those portions of a long object which are sufficient for its definition. The limits of parts retained are shown as for partial views (see 8.2.6), and the portions are drawn close to each other (see Fig. 9.39 and 9.40).

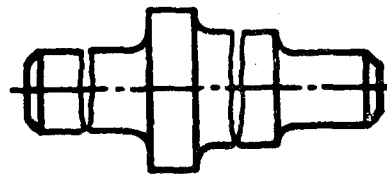


FIG. 9.39

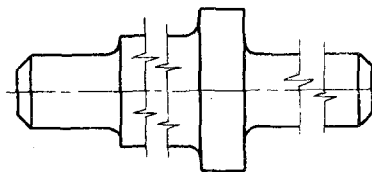


FIG. 9.40

9.3.7 Simplified Representation of Repetitive Features – The presentation of repetitive features may be simplified as shown in Fig. 9.41 and 9.42.

NOTE – In all cases, the number and kind of repetitive features should be defined by dimensioning or by a note.

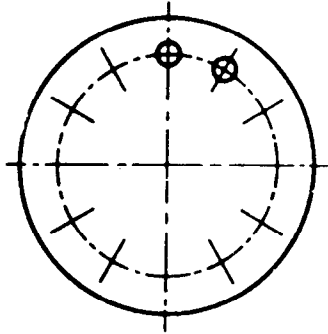


FIG. 9.41

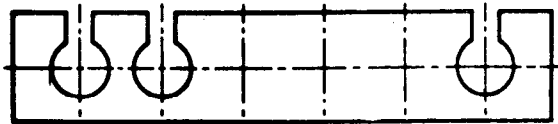


FIG. 9.42

9.3.8 Elements on a Larger Scale

9.3.8.1 In cases where the scale is so small that details of the feature cannot be shown or dimensioned, the feature of the part may be framed by a continuous thin line (type B) and identified by a capital letter (see Fig. 9.43 A).

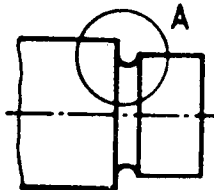


FIG.9.43 A

9.3.8.2 The relevant feature is then drawn to a stated larger scale accompanied by its identification letter (see Fig. 9.43 B).

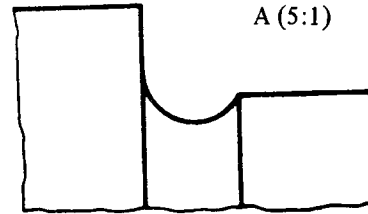


FIG.9.43 B

9.3.9 Initial Outlines – When it is necessary to depict the initial outlines of a part prior to forming, the initial outline shall be indicated by chain thin double dashed lines (type K) (see Fig. 9.44).

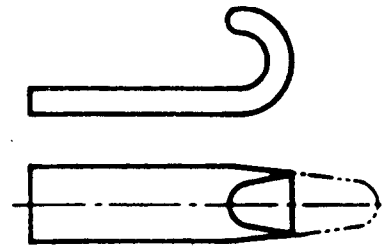


FIG.9.44

9.3.10 Use of Colours – The use of colours on technical drawings is not recommended. If it is essential for clarity to use colours, then their meanings shall be clearly shown on the drawing or in other relevant documents.

9.3.11 Transparent Objects – All objects made of transparent material should be drawn as non-transparent.

SECTION 10 CONVENTIONAL REPRESENTATION

10.1 Scope – This section specifies, by means of examples, the rules for representation of threaded parts, springs, gears and common-features on technical drawings.

10.2 Conventional Representation of Threaded Parts – The method of simplified representation of threaded parts is independent of type of screw thread applied. The type of screw thread and its dimensions are to be indicated by means of standard designations.

10.2.1 Conventional Method of Representation

10.2.1.1 Visible screw threads – For visible screw threads, the crests of threads should be defined by a continuous thick line (type A), and the roots of threads by a continuous thin line (type B) (see Fig. 10.1 to 10.4). It is recommended that the space between lines representing the major and minor diametres of the thread be as close as possible to the correct depth of thread, but in all cases this spacing shall not be less than twice the thickness of the thick line or 0.7 mm whichever is larger.

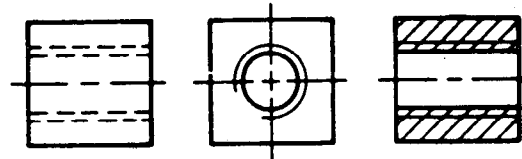


FIG. 10.3

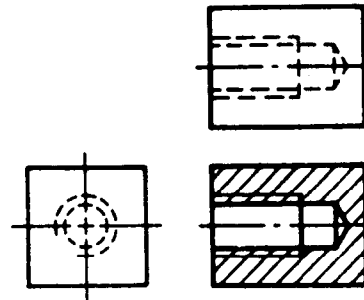


FIG. 10.4

On an end view of a hidden screw thread, the thread roots should be represented by a portion of a circle, drawn with a dashed line (type E or F, but same as that used for the crests and one type only on the same drawing) of the length approximately three-quarters of the circumference (see Fig. 10.4).

10.2.1.5 Limits of useful length of screw threads – The limit of useful length of a screw thread should be shown by a continuous thick line (type A) or a dashed line (type E or F, but one type on the same drawing) according to whether this limit is visible or hidden. This line should terminate at the line defining the major diameter of the thread (see Fig. 10.1, 10.2, 10.4 and 10.6).

10.2.1.6 Incomplete threads (run-outs) – Incomplete threads or the limits of useful length are not shown (see Fig. 10.1, 10.2, 10.4 and 10.6), except in the case where there is a functional necessity (see Fig. 10.5).

10.2.1.7 Assembled threaded parts – The above conventions apply to assemblies of threaded parts. However, externally threaded parts should always be shown covering internally threaded parts and should not be hidden by them (see Fig. 10.5 and 10.6).

10.3 Representation of Springs on Technical Drawings – The rules for representation of springs on technical drawings are specified by examples in the following clauses.

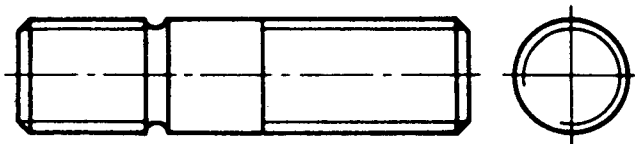


FIG. 10.1

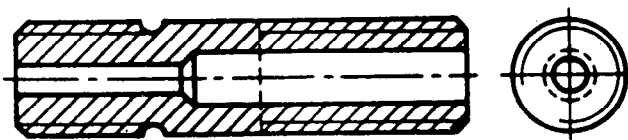


FIG. 10.2

10.2.1.2 Hidden screw threads – For hidden screw threads, the crests and the roots should be defined by dashed lines (type E or F, but one type only on the same drawing) (see Fig. 10.3 and 10.4).

10.2.1.3 Sections of threaded parts – For threaded parts shown in section, hatching should be extended to the line defining the crest of the thread (see Fig. 10.2, 10.3 and 10.4).

10.2.1.4 End view of screw threads – On an end view of a visible screw thread, the thread roots should be represented by a portion of a circle, drawn with a continuous thin line (type B), of length approximately three-quarters of the circumference (see Fig. 10.1, 10.2 and 10.3).

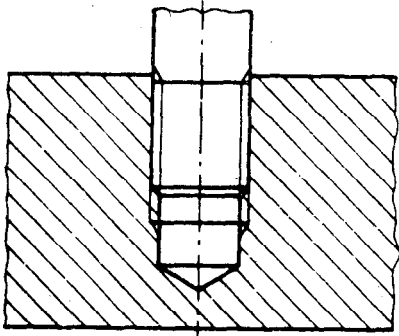


FIG. 10.5

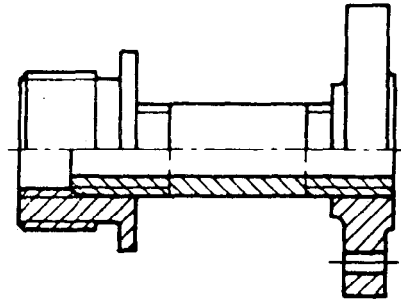


FIG. 10.6

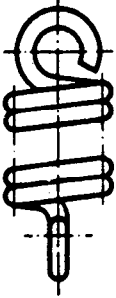
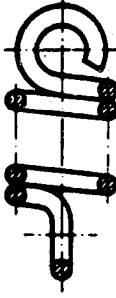

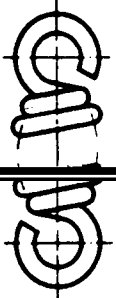


10.3.1 Compression Springs

Title	Representation		
	view	section	simplified ¹⁾
10.3.1.1 Cylindrical helical compression spring of wire of circular cross-section			
10.3.1.2 Cylindrical helical compression spring of wire of rectangular cross-section			
10.3.1.3 Conical helical compression spring of wire of circular cross-section			
10.3.1.4 Conical helical compression spring of wire of rectangular cross-section (volute spring)			

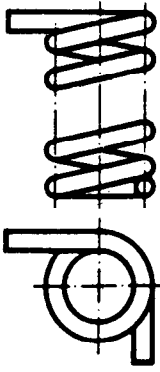
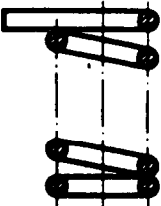
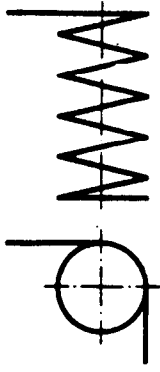
1) If necessary, indicate wound left (or right) hand.

If necessary, the cross-section of the spring material may be indicated in words or by a symbol (see 10.3.1.1 and 10.3.1.2).

10.3.2 Tension Springs








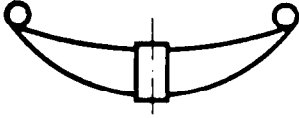
Title	Representation		
	view	section	simplified ¹⁾
10.3.2.1 Cylindrical helical tension spring of wire of circular cross-section			
10.3.2.2 Double-conical helical tension spring of circular cross-section			

10.3.3 Torsion Springs

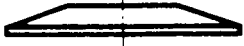
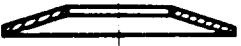
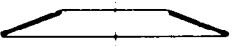



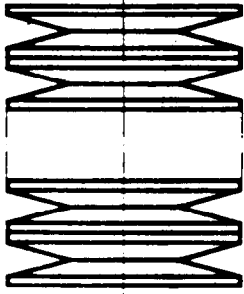
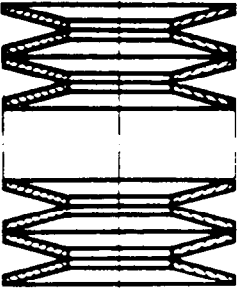
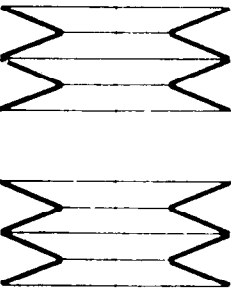
Title	Representation		
	view	section	simplified ¹⁾
10.3.3.1 Cylindrical helical torsion spring of wire of circular cross-section (Wound right hand)			

1) If necessary, indicate wound left (or right) hand.
 If necessary the cross-section of spring material may be indicated in words or by symbol (see 10.3.1.1 and 10.3.1.2)

10.3.4 Leaf Springs

Title	Representation	
	view	simplified
10.3.4.1 Semi-elliptic leaf spring (multi-elliptic spring shown)		
10.3.4.2 Semi-elliptic leaf spring with eyelets		
		
10.3.4.4 Semi-elliptic leaf spring with eyelets and centre band		

10.3.5 Cup Springs

Title	Representation		
	view	section	simplified
10.3.5.1 Cup spring			
10.3.5.2 Multi-cup spring (cups placed in the same direction)			
10.3.5.3 Multi-cup spring (successive cups alternating in direction)			

10.3.6 Spiral Springs

Title	Representation	
	view	simplified
10.3.6.1 Spiral spring		
10.3.6.2 Spiral spring (the spring is wound by rotating the box)		

10.4 Conventional Representation of Gears on Technical Drawings – This clause deals with the conventional representation of toothed portion of gears including worm gearing and chain wheels. It is applicable to detail drawings and assembly drawings. As a fundamental principle, a gear is represented (except in axial section) as a solid part without teeth, but with the addition of the pitch surface in a thin long chain line.

10.4.1 Detail Drawings (Individual Gears)

10.4.1.1 Contours and edges – Represent the contours and the edges of each gear (see Fig. 10.7, 10.8 and 10.9), as if they were:

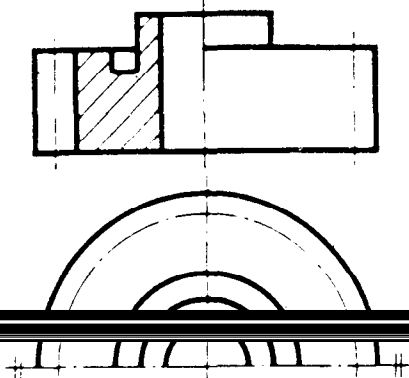


FIG.10.7

- a) in an unsectioned view, a solid gear bounded by the tip surface.
- b) in an axial section, a spur gear having two diametrically opposed teeth, represented unsectioned, even in the case of a gear that does not have spur teeth or that has an odd number of teeth.

10.4.1.2 Pitch surface – Draw the pitch surface with a thin, long chain line, even in concealed portions and sectional views, and represent it:

- a) in a projection normal to the axis, by its pitch circle (external pitch circle in the case of a bevel gear and the median pitch circle in the case of a worm wheel) (see Fig. 10.7, 10.8 and 10.9).
- b) in a projection parallel to the axis, by its apparent contour, extending the line beyond the gear contour on each side (see Fig. 10.7, 10.8 and 10.9).

10.4.1.3 Root surface – As a general rule, do not represent the root surface except in sectional views. However, if it seems helpful to show it also on

thin continuous line (see Fig. 10.10, 10.11 and 10.12).

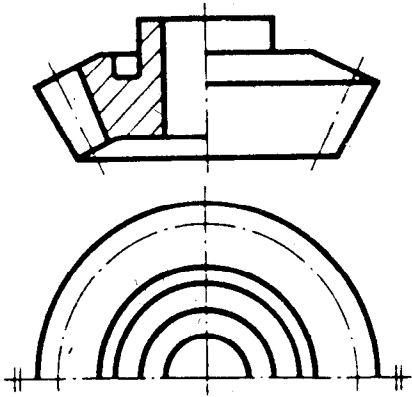


FIG. 10.8

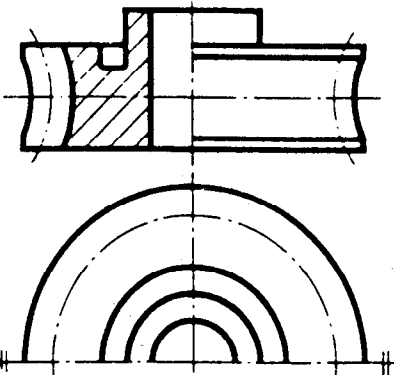


FIG. 10.9

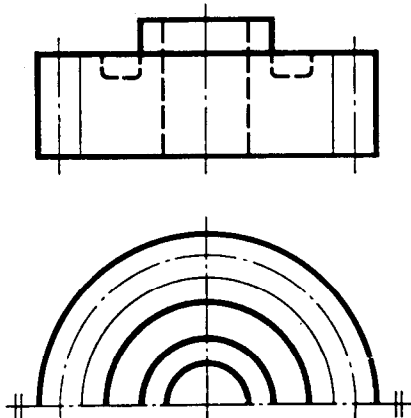


FIG. 10.10

10.4.1.4 *Teeth* – Specify the teeth profile either by reference to a standard or by a drawing to a suitable scale.

If it is essential to show one or two teeth on the drawing itself (either to define the ends of a toothed portion or rack, or in order to specify the position of the teeth in relation to a given axial plane), draw them as thick continuous lines (see Fig. 10.11 and 10.12).

It is necessary to indicate the direction of the teeth of a gear or rack on the view of the tooth

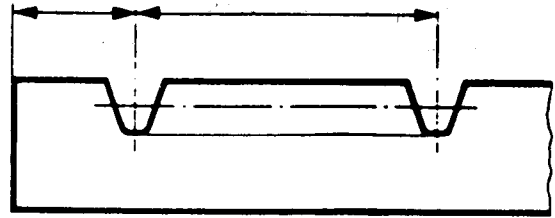


FIG. 10.11

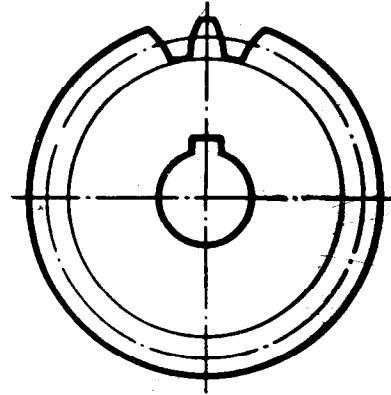


FIG. 10.12

surface in a projection parallel to the gear axes, three thin continuous lines of the corresponding form and direction should be shown (see Table 10.1 and Fig. 10.13).

TABLE 10.1

<i>Tooth System</i>	<i>Symbol</i>
Helical to the right	
Helical to the left	
Double helical	
Spiral	

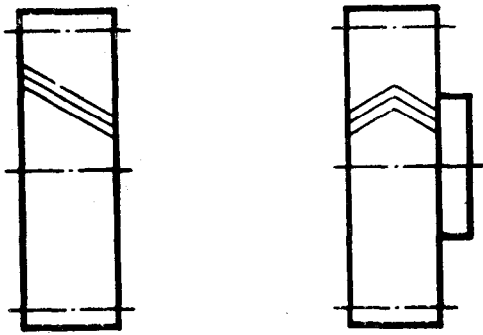


FIG. 10.13

NOTE - If mating gears are represented, the direction of the teeth should be shown on one gear only.

10.4.2.1 External engagement of cylindrical gears (see Fig. 10.14).

10.4.2.2 Internal engagement of cylindrical gears

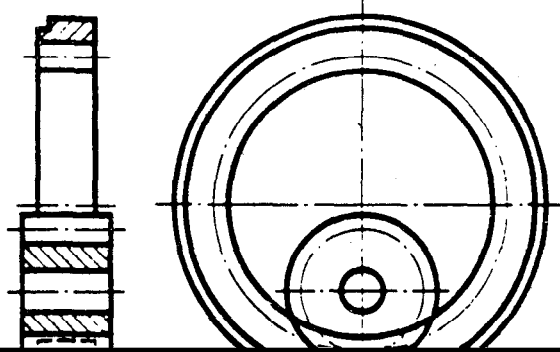


FIG. 10.15

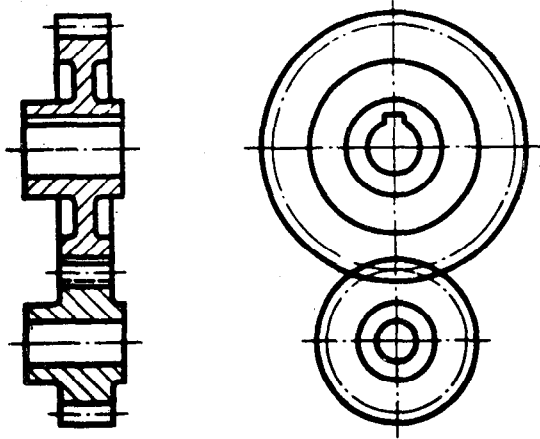
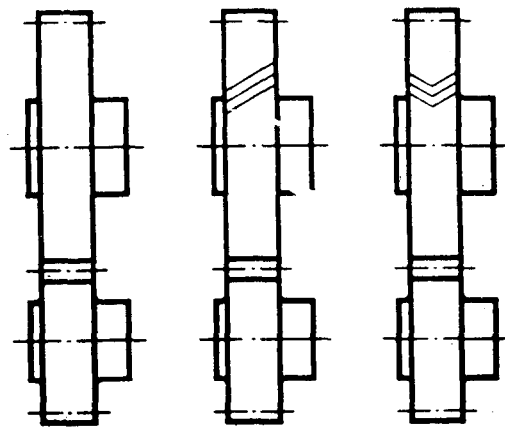


FIG. 10.14



10.4.2.3 Engagement of pinion with rack

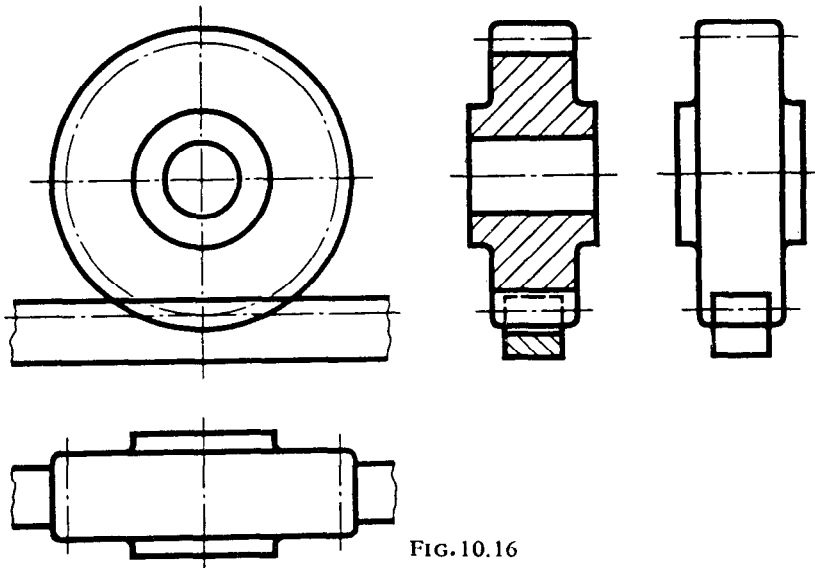


FIG. 10.16

10.4.2.4 Engagement of bevel gears, axis intersection at any angle

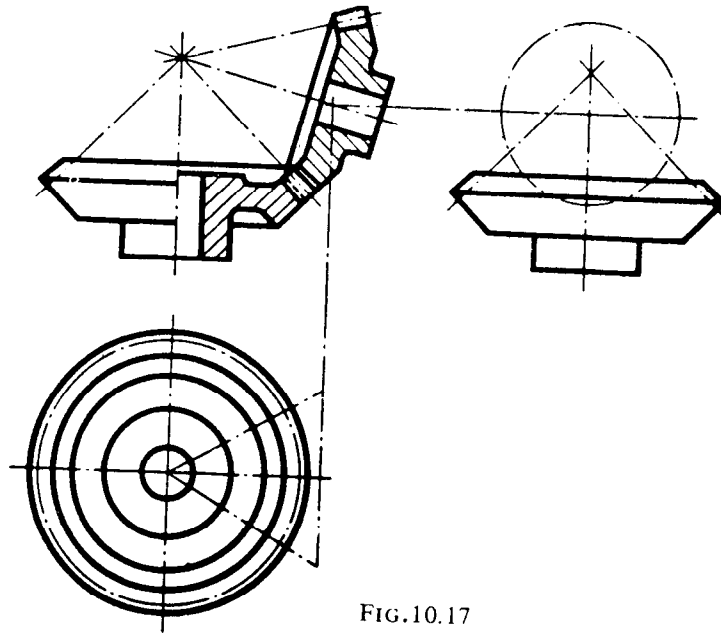


FIG.10.17

10.4.2.5 Engagement with cylindrical worm, in cross-section

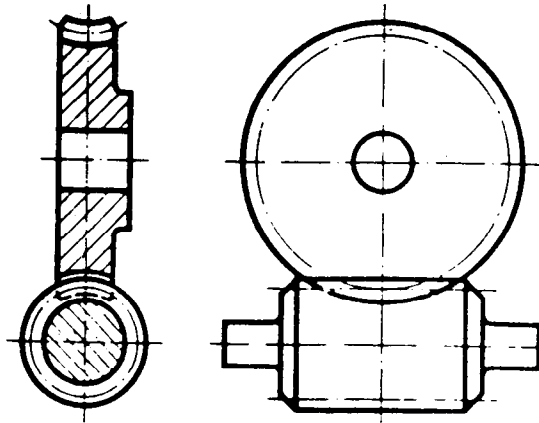


FIG.10.18

10.4.2.6 Chain wheels

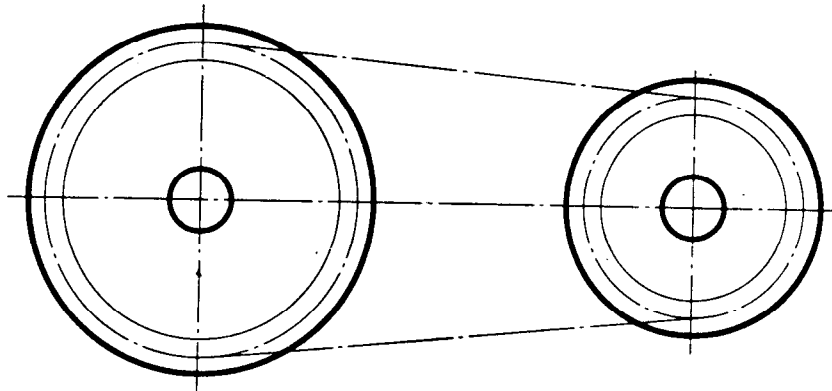
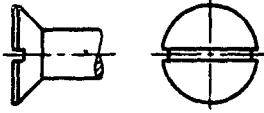
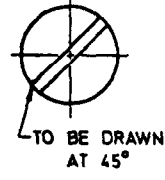
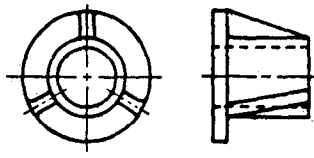
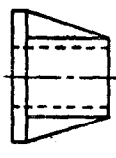
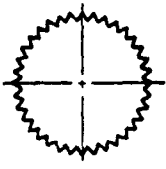
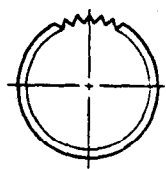
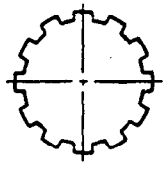
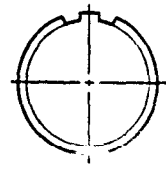
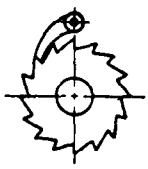

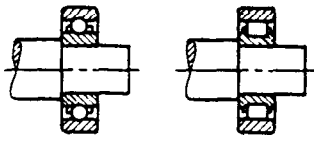
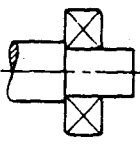
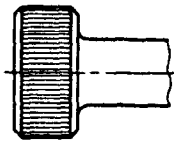
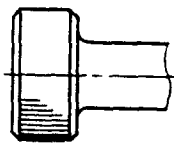
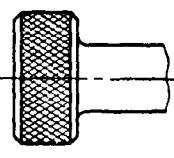
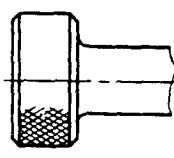
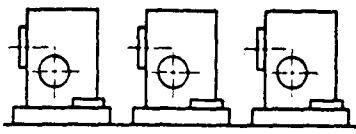
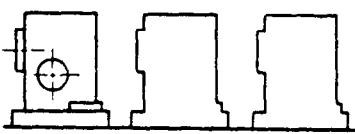


FIG.10.19

TABLE 10.2 CONVENTIONAL REPRESENTATION OF COMMON FEATURES

TITLE	ACTUAL PROJECTION/SECTION	CONVENTION
SLOTTED HEAD		 <p>TO BE DRAWN AT 45°</p>
RADIAL RIBS		
SERRATED SHAFT		
SPLINED SHAFT		
RATCHET AND PINION		
BEARINGS		
STRAIGHT KNURLING		
DIAMOND KNURLING		
REPEATED PARTS		

SECTION 11 GENERAL PRINCIPLES OF DIMENSIONING ON TECHNICAL DRAWINGS

11.1 Scope and Field of Application

11.1.1 This section establishes the general principles of dimensioning applicable in all fields (that is mechanical, electrical, civil engineering, architecture, etc). It is possible that in some specific technical areas, the general rules and conventions will not cover all the needs of specialized practices adequately. In such cases additional rules may be laid down in standards specific to these areas. However, the general principles of this section shall be followed to facilitate the international exchange of drawings and to ensure the coherence of drawings in a comprehensive system relating to several technical fields.

11.1.2 The figures as shown in this section, merely illustrate the text and are not intended to reflect actual usage. The figures are consequently simplified to indicate only the relevant general principles applicable in any technical field.

11.2 General Principles

11.2.1 *Definitions* – For the purpose of this section, the following definitions apply.

b) *Non-functional dimension* – A dimension that is not essential to the function of the piece or space (see *NF* in Fig. 11.1).

c) *Auxiliary dimension* – A dimension given for information purposes only. It does not govern production or inspection operations and is derived from other values shown on the drawing or in related documents. An auxiliary dimension is given in parentheses and no tolerance applies to it (see *AUX* in Fig. 11.1).

11.2.1.2 *Feature* – An individual characteristic such as flat surface, a cylindrical surface, two parallel surfaces, a shoulder, a screw thread, a slot, a profile, etc.

11.2.1.3 *End product* – The complete part ready for assembly or service or a configuration produced from a drawing specification. An end product may also be a part ready for further processing (for example, the product of a foundry or forge) or a configuration needing further processing.

11.2.2 Application

expressed in appropriate units or measurement and indicated graphically on technical drawings with lines, symbols and notes.

Dimensions are classified according to the following types:

a) *Functional dimension* – A dimension that is essential to the function of the piece or space (see *F* in Fig. 11.1).

completely shall be shown directly on a drawing unless this information is specified in associated documentation.

11.2.2.2 Each feature shall be dimensioned once only on a drawing.

11.2.2.3 Dimensions shall be placed on the view or section that most clearly shows the corresponding features.

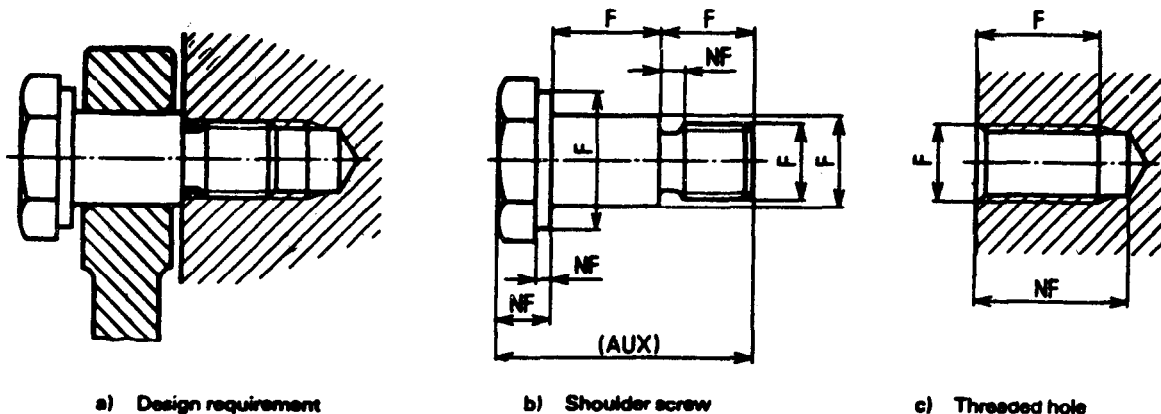


FIG 11.1 FUNCTIONAL, NON-FUNCTIONAL AND AUXILIARY DIMENSIONS

11.2.2.4 Each drawings shall use the same unit (for example, millimetres) for all dimensions but without showing the unit symbol. In order to avoid misinterpretation, the predominant unit symbol on a drawing may be shown in a note.

Where other units have to be shown as part of the drawing specification (for example, N-m for torque or kPa for pressure), the appropriate unit symbol shall be shown with the value.

11.2.2.5 No more dimensions than are necessary to define a part or an end product shall be shown on a drawing. No feature of a part or an end product shall be defined by more than one dimension in any one direction. Exception may, however, be made:

- a) where it is necessary to give additional dimensions at intermediate stages of production (for example, the size of a feature prior to carburizing and finishing);
- b) where the addition of an auxiliary dimension would be advantageous.

11.2.2.6 Production processes or inspection methods should not be specified unless they are essential to ensure satisfactory functioning or interchangeability.

11.2.2.7 Functional dimensions should be shown directly on the drawing wherever possible (see Fig. 11.2).

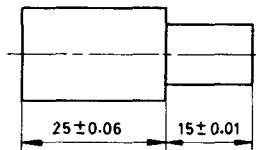


FIG.11.2 FUNCTIONAL DIMENSIONING

Occasionally indirect functional dimensioning is justified or necessary. In such cases, care must be exercised so that the effect of directly shown functional dimensioning is maintained. Figure 11.3 shows the effect of acceptable indirect functional dimensioning that maintains the dimensional requirements established by Fig. 11.2.

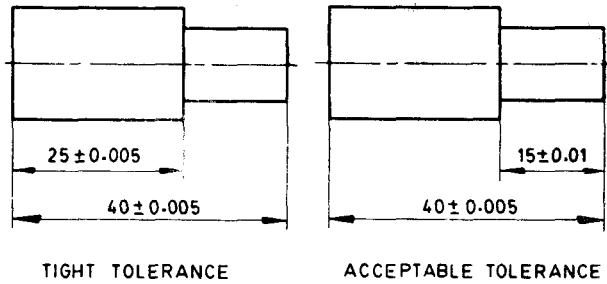


FIG.11.3 INDIRECT FUNCTIONAL DIMENSIONING

11.2.2.8 The non-functional dimensions should be placed in a way which is most convenient for production and inspection.

11.3 Method of Dimensioning

11.3.1 Elements of Dimensioning – The elements of dimensioning include the projection line, dimension line, leader line, dimension line termination, the origin indication, and the dimension itself. The various elements of dimensioning are illustrated in Fig. 11.4 and 11.5.

11.3.2 Projection Lines, Dimension Lines and Leader Lines – Projection lines, dimension lines and leader lines are drawn as thin continuous lines as shown in Section 6 and as illustrated in Fig. 11.4 and 11.5.

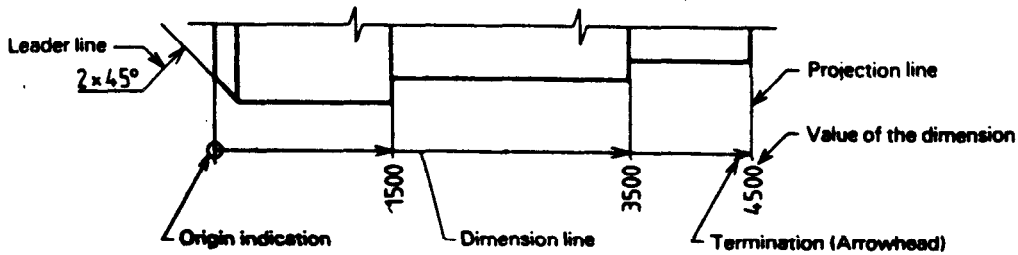


FIG.11.4

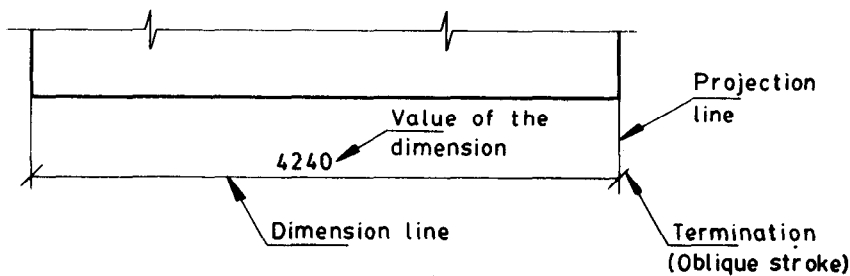


FIG.11.5

11.3.2.1 Projection lines shall extend slightly beyond the respective dimension line (see Fig. 11.4 and 11.5).

11.3.2.2 Projection lines should be drawn perpendicular to the feature being dimensioned. Where necessary, however, they may be drawn obliquely, but parallel to each other (see Fig. 11.6).

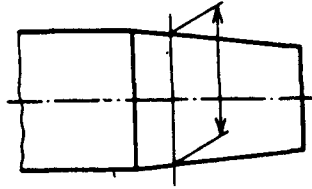


FIG. 11.6

11.3.2.3 Intersecting construction and projection lines shall extend slightly beyond their point of intersection (see Fig. 11.7).

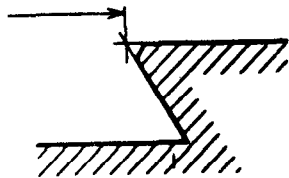


FIG. 11.7

11.3.2.4 In general, projection lines and dimension lines should not cross other lines unless this is unavoidable (see Fig. 11.8).

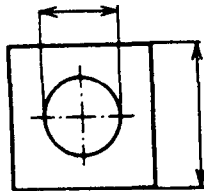


FIG. 11.8

11.3.2.5 A dimension line shall be shown unbroken where the feature to which it refers is shown broken (see Fig. 11.9), except as indicated in 11.3.4.1, method 2.

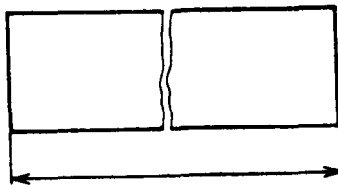


FIG. 11.9

11.3.2.6 Intersecting projection and dimension lines should be avoided. Where unavoidable, however, neither line shall be shown with a break (see Fig. 11.10).

11.3.2.7 A centreline or the outline of a part shall not be used as a dimension line but may be used in place of a projection line (see Fig. 11.10).

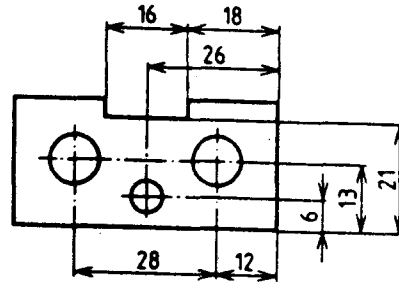
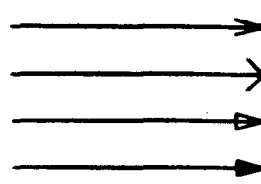


FIG. 11.10

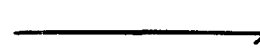
11.3.3 Terminations and Origin Indication -- Dimension lines shall show distinct terminations (that is either arrowheads or oblique strokes), or, where applicable, an origin indication.

11.3.3.1 Two dimension line terminations (see Fig. 11.11) and an origin indication (see Fig. 11.12) are specified in this section. They are:

- the arrowhead, drawn as short lines forming barbs at any convenient included angle between 15° and 90° . The arrowhead may be open, closed, or closed and filled in [see Fig. 11.11 (a)]
- the oblique stroke, drawn as a short line inclined at 45° [see Fig. 11.11 (b)];
- the origin indication, drawn as a small open circle of approximately 3 mm in diameter (see Fig. 11.12).



a) Arrowheads



b) Oblique Stroke

FIG. 11.11



FIG. 11.12

11.3.3.2 The size of the terminations shall be proportionate to the size of drawing on which they are used but not larger than is necessary to read the drawing.

11.3.3.3 One style of arrowhead termination only shall be used on a single drawing. However, where space is too small for an arrowhead, the oblique stroke or a dot may be substituted (see Fig. 11.24).

11.3.3.4 Arrowhead terminations shall be shown within the limits of the dimension line where space is available (see Fig. 11.13). Where space is limited, the arrowhead termination may be shown outside the intended limits of the dimension line that is extended for that purpose (see Fig. 11.14).



FIG. 11.13

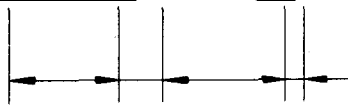


FIG. 11.14

11.3.3.5 Only one arrowhead termination, with its point on the arc end of the dimension line, shall be used where a radius is dimensioned (see Fig. 11.15). The arrowhead termination may be either on the inside or on the outside of the feature outline, (or its projectionline) depending upon the size of the feature.

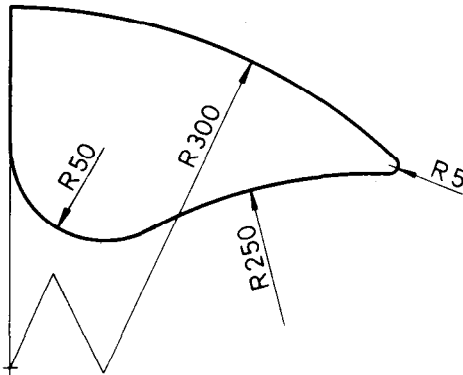


FIG. 11.15

11.3.4 Indicating Dimensional Values on Drawings

- a) Dimensional values shall be shown on drawings in characters of sufficient size to ensure complete legibility on the original drawing as well as on reproductions made from microfilms.
- b) They shall be placed in such a way that they are not crossed or separated by any other line on the drawing.

11.3.4.1 Values shall be indicated on a drawing according to one of the following two methods. Only one method should be used on any one drawing.

Method 1

- a) Dimensional values shall be placed parallel to their dimension lines and preferably near the middle, above and clear of the dimension line (see Fig. 11.16).

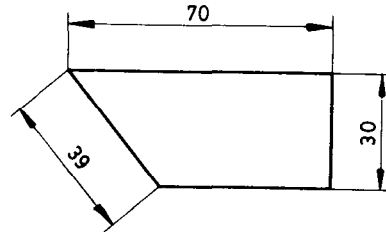


FIG. 11.16

b) An exception may be made where imposed running dimensions are used (see 11.4.2.4).

However, values shall be indicated so that they may be read from the bottom or from the right hand side of the drawing. Values on oblique dimension lines shall be oriented as shown in Fig. 11.17.

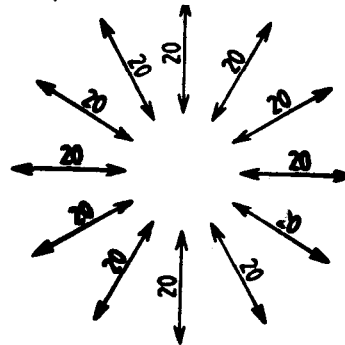


FIG. 11.17

- c) Angular dimensional values may be oriented either as in Fig. 11.18 or Fig. 11.19.

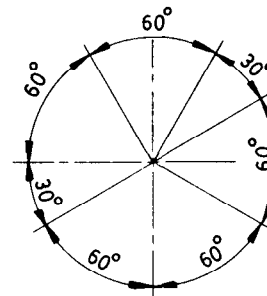


FIG. 11.18

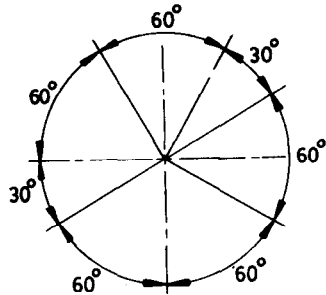


FIG. 11.19

Method 2

- a) Dimensional values shall be indicated so that they may be read from the bottom of the drawing sheet. Non-horizontal dimension lines are interrupted, preferably near the middle so that the value may be inserted (see Fig. 11.20 and 11.21).

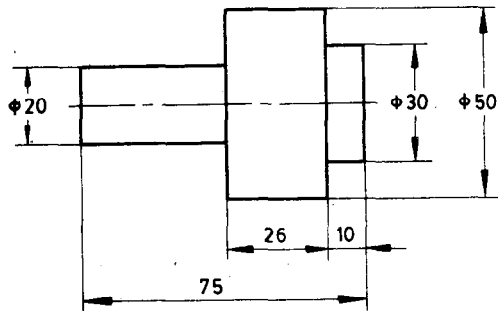


FIG. 11.20

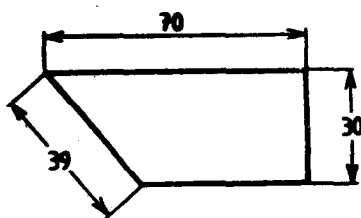


FIG. 11.21

- b) Angular dimensional values may be oriented either as in Fig. 11.19 or 11.22.

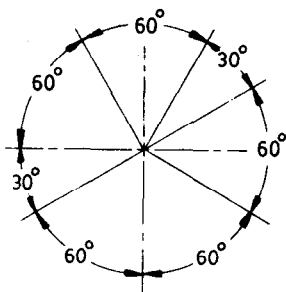


FIG. 11.22

11.3.4.2 The positioning of dimensional values frequently needs adapting to different situations. Therefore, for example, values may be:

- a) closer to a termination to avoid having to follow a long dimension line where only part of the dimension line needs to be shown (see Fig. 11.23)

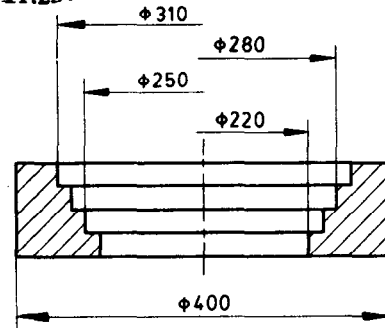


FIG. 11.23

- b) above the extension of the dimension line beyond one of the terminations if space is limited (see Fig. 11.24).

- c) at the end of a leader line which terminates on a dimension line that is too short for dimensional value to be indicated in the usual way (see Fig. 11.24).

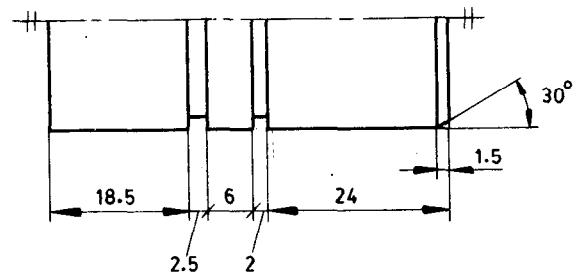


FIG. 11.24

- d) above a horizontal extension of a dimension line where space does not allow placement at the interruption of a non-horizontal dimension line (see Fig. 11.25).

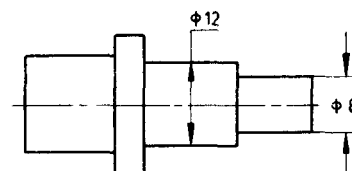


FIG. 11.25

11.3.4.3 Values for dimensions out-of-scale (except where break lines are used) shall be underlined with a straight thick line (see Fig. 11.26).

NOTE - Dimensions out-of-scale can result from a feature size modification where the modification does not warrant an extensive drawing revision to correct the feature scale.

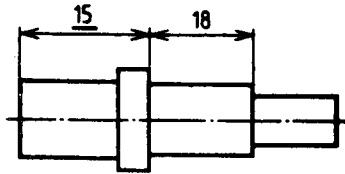


FIG. 11.26

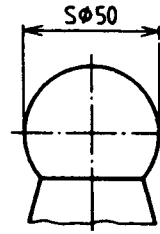


FIG. 11.31

11.3.4.4 The following indications are used with dimensions to show applicable shape identification and to improve drawing interpretation. The diameter and square symbols may be omitted where the shape is clearly indicated. The applicable indication (symbol) shall precede the value for dimension (see Fig. 11.27 to 11.31).

- φ : Diameter
- R : Radius
- : Square
- Sφ : Spherical diameter
- SR : Spherical radius

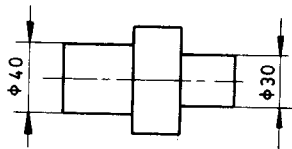


FIG. 11.27

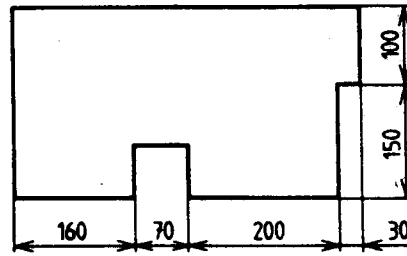


FIG. 11.32

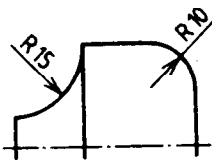


FIG. 11.28

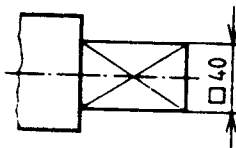


FIG. 11.29

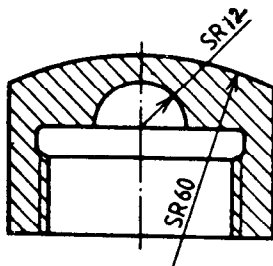


FIG. 11.30

11.4 Arrangement and Indication of Dimensions - The arrangement of dimensioning on a drawing shall indicate clearly the design purpose. Generally, the arrangement of dimensions is the result of a combination of various design requirements.

11.4.1 Chain Dimensioning - Chains of single dimensions (see Fig. 11.32) should be used only where the possible accumulation of tolerances does not impinge on the functional requirements of the part. Any termination may be used for chain dimensioning except the 90° arrowhead [see Fig. 11.11 (a)].

11.4.2 Dimensioning From a Common Feature

11.4.2.1 This method of dimensioning is used where a number of dimensions of the same direction relate to a common origin.

11.4.2.2 Dimensioning from a common feature may be executed as parallel dimensioning or as superimposed running dimensioning.

11.4.2.3 Parallel dimensioning is the placement of a number of single dimension lines parallel one to another and spaced out so that the dimensional value can easily be added in (see Fig. 11.33 and 11.41).

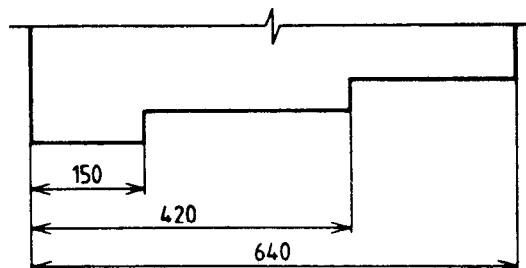


FIG. 11.33

11.4.2.4 Superimposed running dimensioning is simplified parallel dimensioning and may be used where there are space limitations and where no legibility problems would occur (see Fig. 11.34 and 11.35).

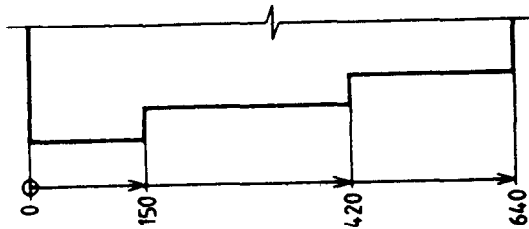


FIG. 11.34

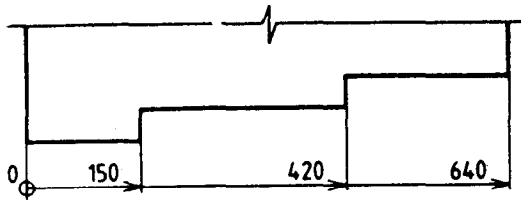


FIG. 11.35

The origin indication (see Fig. 11.12) is placed appropriately and the opposite ends of each dimension line shall be terminated only with an arrowhead.

Dimensional values may be placed, where there is no risk of confusion, either:

- near the arrowhead, in line with the corresponding projection line (see Fig. 11.34), or
- near the arrowhead, above and clear of the dimension line (see Fig. 11.35).

11.4.2.5 It may be advantageous to use superimposed running dimensioning in two directions. In such a case, the origins may be as shown in Fig. 11.36.

11.4.3 Dimensioning by Coordinates

11.4.3.1 It may be useful, instead of dimensioning as shown in Fig. 11.36, to tabulate dimensional values as shown in Fig. 11.37.

11.4.3.2 Coordinates for intersections in grids on block plans (site plans) are indicated as shown in Fig. 11.38.

Coordinates for arbitrary points of reference without a grid shall appear adjacent to each point (see Fig. 11.39) or in tabular form (see Fig. 11.40).

11.4.4 Combined Dimensioning - Single dimensions, chain dimensioning and dimensioning from a common feature may be combined on a drawing, if necessary (see Fig. 11.41 and 11.42).

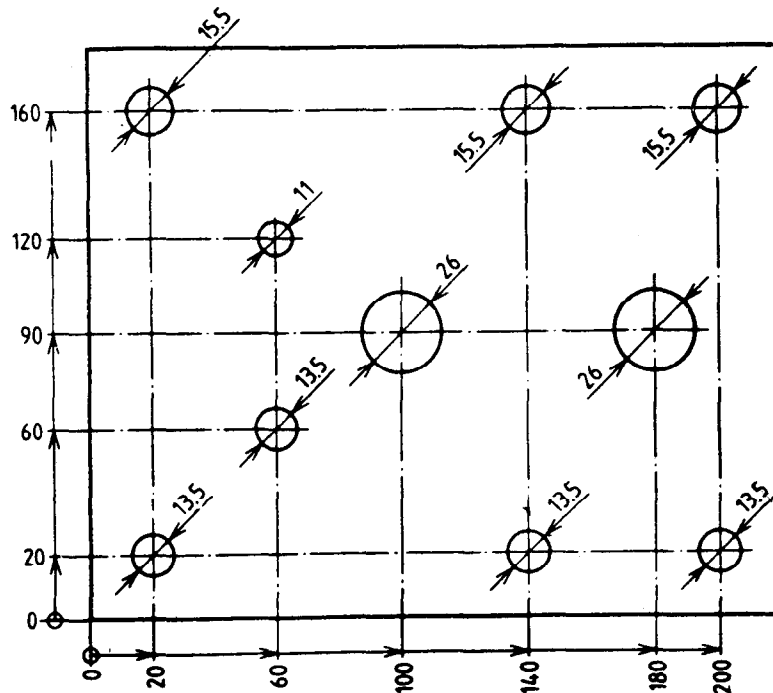


FIG. 11.36

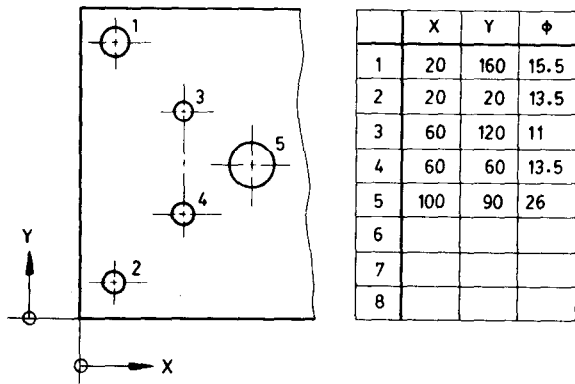


FIG. 11.37

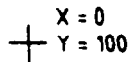


FIG. 11.38

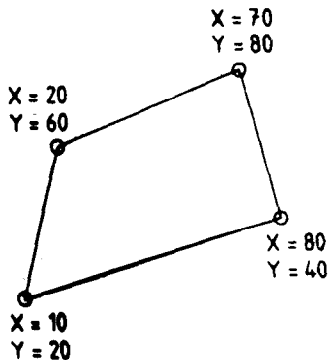


FIG. 11.39

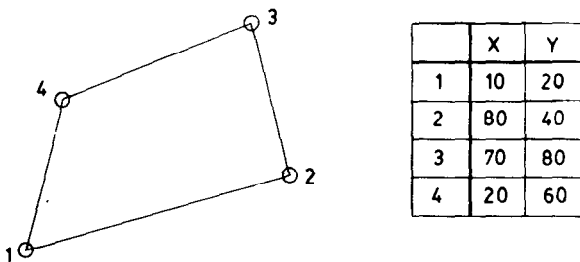


FIG. 11.40

11.5 Special Indications

11.5.1 Chords, Arcs, Angles and Radii

11.5.1.1 The dimensioning of chords, arcs and angles shall be as shown in Fig. 11.43.

11.5.1.2 Where the centre of an arc falls outside the limits of the space available, the dimension line of the radius shall be broken or interrupted according to whether or not it is necessary to locate the centre (see Fig. 11.15).

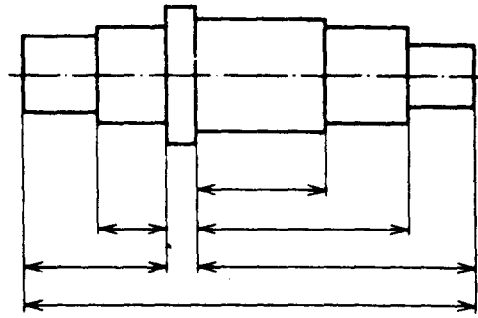


FIG. 11.41

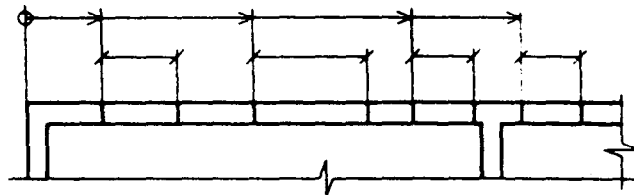


FIG. 11.42

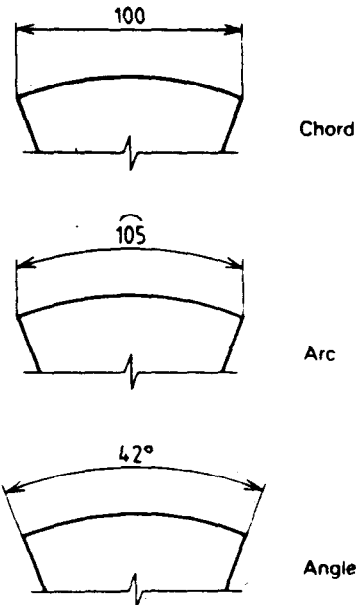


FIG. 11.43

11.5.1.3 Where the size of the radius can be derived from other dimensions, it shall be indicated with a radius arrow and the symbol *R* without an indication of the value (see Fig. 11.44).

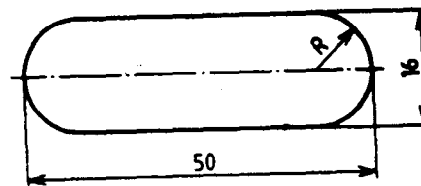


FIG. 11.44

11.5.2 Equidistant Features – Where equidistant features or uniformly arranged elements are part of the drawing specification, dimensioning may be simplified as follows.

11.5.2.1 Linear spacings may be dimensioned as shown in Fig. 11.45. If there is any possibility of confusion between the length of the space and the number of spacings, one space shall be dimensioned as shown in Fig. 11.46.

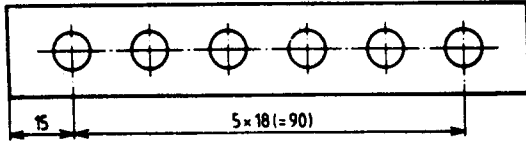


FIG. 11.45

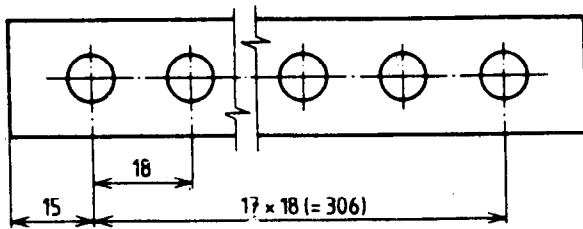


FIG. 11.46

11.5.2.2 Angular spacings of holes and other features may be dimensioned as shown in Fig. 11.47.

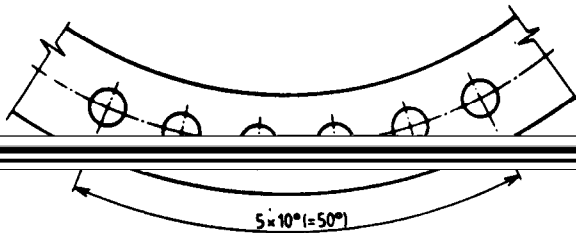


FIG. 11.47

11.5.2.3 The angles of the spacings may be omitted if their number is evident without confusion (see Fig. 11.48).

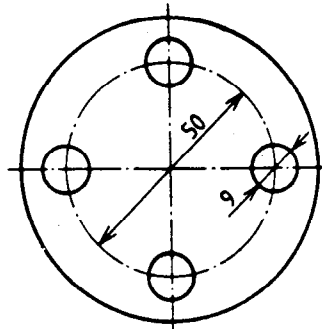


FIG. 11.48

11.5.2.4 Circular spacings may be dimensioned indirectly by giving the number of elements as shown in Fig. 11.49.

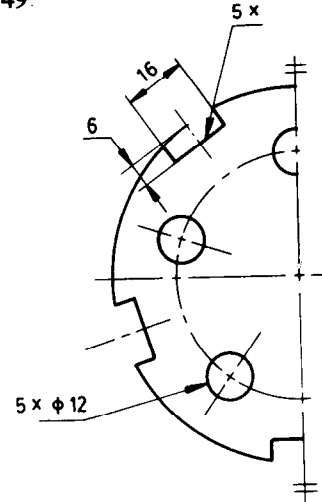


FIG. 11.49

11.5.3 Repeated Features – If it is possible to define a quantity of elements of the same size so as to avoid repeating the same dimensional value, they may be given as shown in Fig. 11.50 and 11.51.

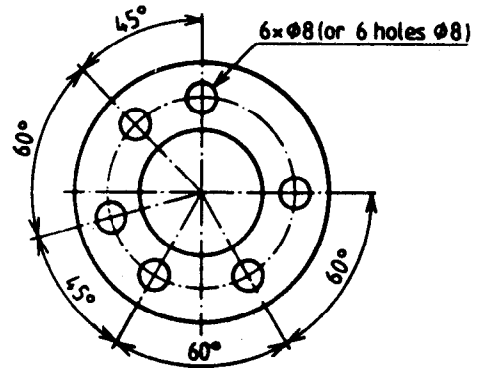
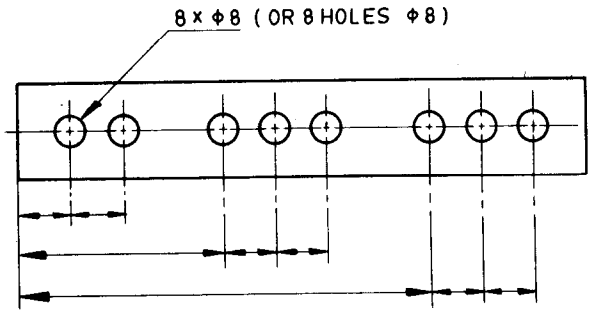


FIG. 11.51

11.5.4 Chamfers and Countersinks

11.5.4.1 Chamfers shall be dimensioned as shown in Fig. 11.52. Where the chamfer angle is 45°, the indications may be simplified as shown in Fig. 11.53 and 11.54.

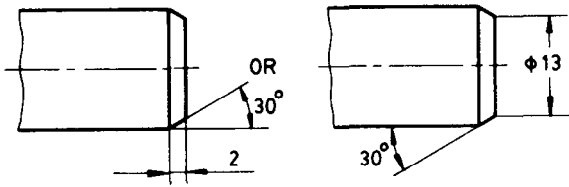


FIG. 11.52 CHAMFERS DIMENSIONED

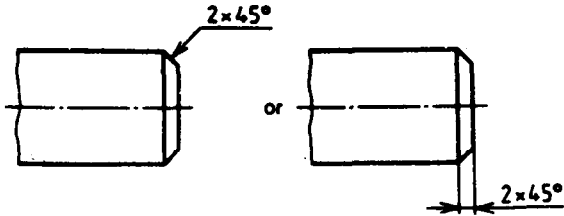


FIG. 11.53 45° CHAMFERS SIMPLIFIED

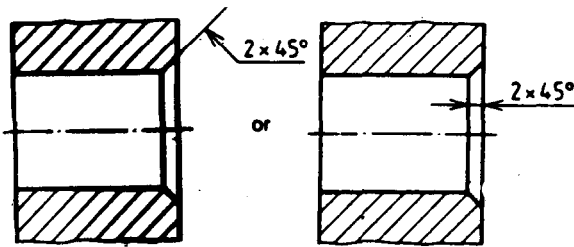


FIG. 11.54 INTERNAL CHAMFERS

11.5.4.2 Countersinks are dimensioned by showing either the required diametral dimension at the surface and the included angle, or the depth and the included angle (see Fig. 11.55).

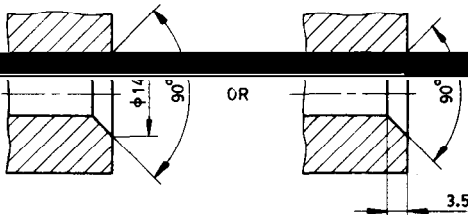


FIG. 11.55 COUNTERSINKS

11.5.5 Other Indications

11.5.5.1 Where necessary, in order to avoid repeating the same dimensional value or to avoid long leader lines, reference letters may be used in connection with an explanatory table or note (see Fig. 11.56). Leader lines may be omitted.

11.5.5.2 In partially drawn views and partial sections of symmetrical parts, the dimension lines that

need to cross the axis of symmetry are shown extended slightly beyond the axis of symmetry; the second termination is then omitted (see Fig. 11.57).

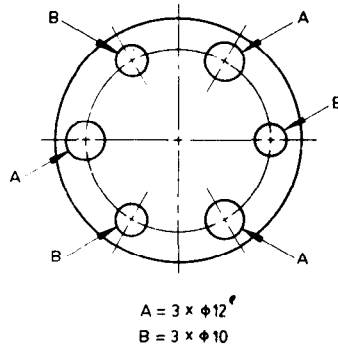


FIG. 11.56

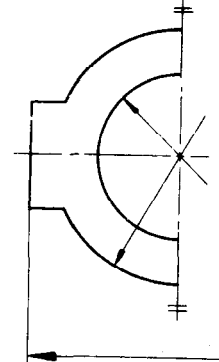


FIG. 11.57

11.5.5.3 Where several parts are drawn and dimensioned in an assembly, the groups of dimensions related to each part should be kept as separate as possible (see Fig. 11.58).

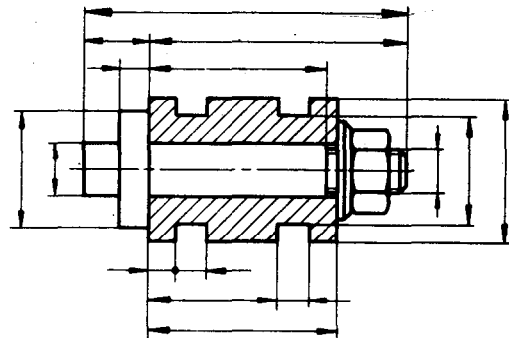


FIG. 11.58 DIMENSIONING AN ASSEMBLY

a limited area or length of a surface to indicate a special condition. In such instances, the area or length and its location are indicated by a long thick chain line, drawn adjacent and parallel to the surface and at a short distance from it.

11.5.5.5 If special requirement is applied to an element of revolution, the indication shall be shown on one side only (see Fig. 11.59).

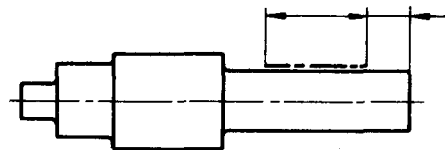


FIG. 11.59

11.5.5.6 Where the location and extent of the special requirement requires identification, the appropriate dimensioning is necessary. However, where the drawing clearly shows the extent of the indication, dimensioning is not necessary (see Fig. 11.60).

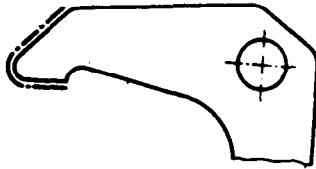


FIG. 11.60

11.6 Indication of Levels

11.6.1 General – Levels shall be expressed in appropriate units from a predetermined base-zero level.

11.6.2 Levels on Vertical Views and Sections

11.6.2.1 The predetermined base-zero level on vertical views and sections shall be indicated with a closed arrowhead with barbs at an included angle of 90°. The arrowhead shall point to a horizontal line, shall be half filled in, and shall be connected to a horizontal leader line by means of a short thin line (see Fig. 11.61).

11.6.2.2 If it is required to indicate the altitude of the base-zero level, the base-zero level symbol is modified to include 0.000 directly above and the actual altitude directly below the horizontal leader line (see Fig. 11.62).

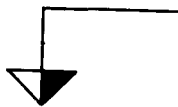


FIG. 11.61

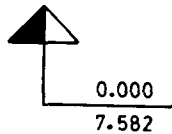


FIG. 11.62

11.6.2.3 Subsequent levels are indicated in vertical views and sections with an arrowhead with barbs at an included angle of 90° pointing to the respective level and attached to a short thin vertical line. The vertical line is connected, at right angles to a horizontal leader line above which is placed the appropriate level dimension (see Fig. 11.63).

11.6.3 Levels on Horizontal (Plan) Views and Sections

11.6.3.1 The numerical value of the level for a point (a specific location) shall be placed above the leader line that is connected to an X. The X is used to indicate the exact position of a particular point (see Fig. 11.64).

11.6.3.2 If the specific location point is defined by two intersecting outlines, the X shall be replaced

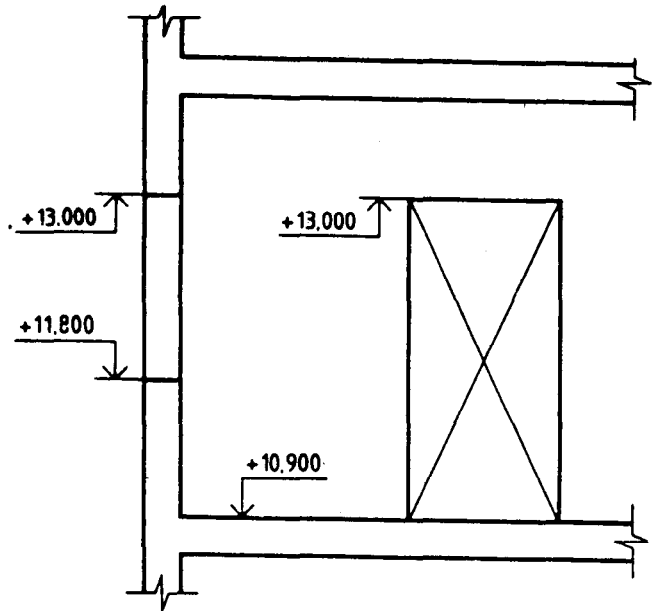


FIG. 11.63

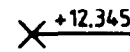


FIG. 11.64

with a circle and the numerical value of the elevation shall be located above the leader line that is extended from the circle on the same side of the outline as the surface associated with the elevation (see Fig. 11.65).

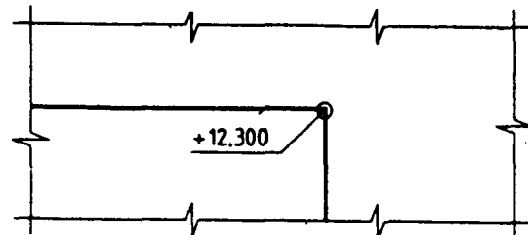


FIG. 11.65

11.6.3.3 The numerical value of an elevation of an outline shall be located adjacent to it and on the same side of it as the surface associated with the elevation (see Fig. 11.66).

11.6.4 Levels on Site Layout

11.6.4.1 Levels on ground preparation drawings and site plans shall be given as follows:

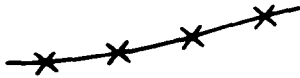
Original ground level to be used	+ 0.000
New ground level	+ 0.000
Original ground level no longer valid	(+0.000)

11.6.4.2 Levels for contour lines shall be located on the upper side of the contour line and shall be given as follows:

Contour line



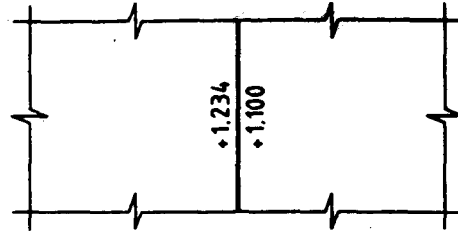
Original contour line no longer valid



11.6.4.3 Elevation datum to be used when setting out dimensions shall be shown as follows:

⊕ FIX +0.000

Example



Meaning

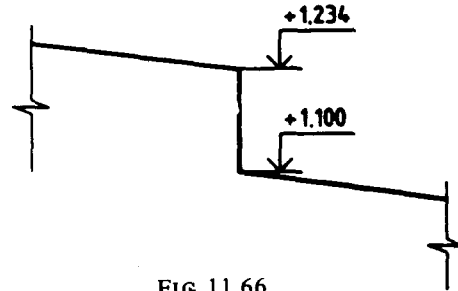


FIG.11.66

SECTION 12 INDICATION OF LINEAR AND ANGULAR TOLERANCES ON TECHNICAL DRAWING

12.1 Scope – This section specifies the indication of tolerances for linear and angular dimensions on technical drawings. Indicating such tolerances does not necessarily imply the use of any particular method of production, measurement or gauging.

12.2 Units

12.2.1 Units of the deviations shall be expressed in the same unit as the basic size.

12.2.2 If two deviations relating to the same dimension have to be shown, both shall be expressed to the same number of decimal places (see Fig. 12.2), except if one of the deviations is zero (see Fig. 12.5).

12.3 Indication of the Components of a Linear Dimension

12.3.1 ISO Symbols – The components of the tolerated dimension shall be indicated in the following order:

- a) the basic size, and
- b) the tolerance symbol.

12.3.1.1 If, in addition to the symbols (see Fig. 12.1), it is necessary to express the values of the deviations (see Fig. 12.2) or the limits of size (see Fig. 12.3), the additional information shall be shown

12.3.2 Permissible Deviations – The components of the tolerated dimension shall be indicated in the following order (see Fig. 12.4 to 12.6):

- a) the basic size, and
- b) the values of the deviations.

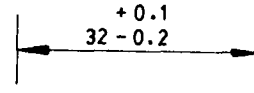


FIG. 12.4

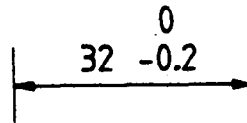


FIG. 12.5

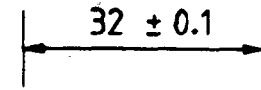


FIG. 12.6

12.3.2.1 If one of the two deviations is zero, this should be expressed by the digit zero (see Fig. 12.5).

12.3.2.2 If the tolerance is symmetrical in relation to the basic size, the value of the deviations sign ± (see Fig. 12.6).

12.3.3 Limits of Size – The limits of size may be indicated by an upper and lower dimension (see Fig. 12.7).

12.3.4 Limits of Size in One Direction – If a dimension needs to be limited in one direction only, this should be indicated by adding "min" or "max" to the dimension (see Fig. 12.8).

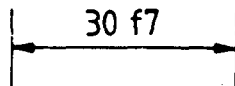


FIG. 12.1

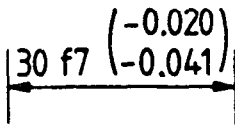


FIG. 12.2

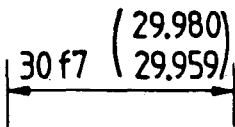


FIG. 12.3

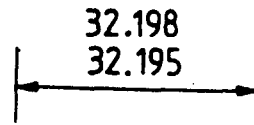


FIG. 12.7

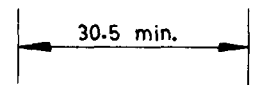


FIG. 12.8

12.4 Order of Indication of Deviations and Limits of Size – The upper deviation or the upper limit of size shall be written in the upper position and the lower deviation or the lower limit of size in the lower position, irrespective of whether a hole or a shaft is toleranced.

12.5 Indication of Tolerances on Drawings of Assembled Parts

12.5.1 ISO Symbols

12.5.1.1 The tolerance symbol for the hole shall be placed before that for the shaft (see Fig. 12.9) or above it (see Fig. 12.10), the symbols being preceded by the basic size indicated once only.

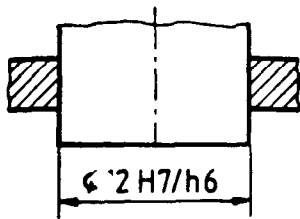


FIG. 12.9

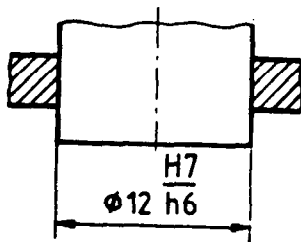


FIG. 12.10

12.5.1.2 If it is also necessary to specify the numerical values of the deviations, they should be written in brackets (see Fig. 12.11).

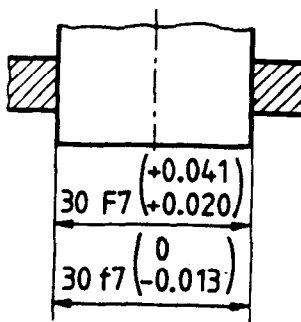


FIG. 12.11

For the sake of simplicity, dimensioning with only one dimension line may be used (see Fig. 12.12).

12.5.2 Values by Digits – The dimension for each of the components of the assembled parts shall be

preceded by the name (see Fig. 12.12) or item reference (see Fig. 12.13) of the components, the dimension for the hole being placed in both cases above that for the shaft.

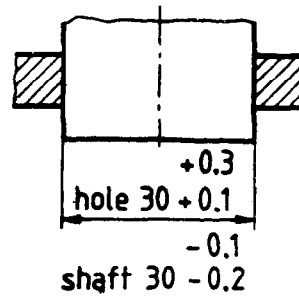


FIG. 12.12

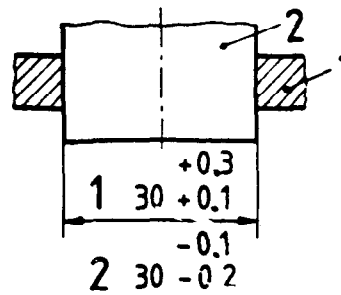


FIG. 12.13

12.6 Indication of Tolerances on Angular Dimensions

– The rules given for the indication of tolerances on linear dimensions are equally applicable to angular dimensions (see Fig. 12.16 and 12.17), except that the units of the basic angle and the fractions thereof, as well as the deviations, shall always be indicated, (see Fig. 12.14 to 12.17). If the angular deviation is expressed in either minutes of a degree or seconds of a minute of a degree, the value of the minute or second shall be preceded by 0° or $0' 0''$ as applicable.

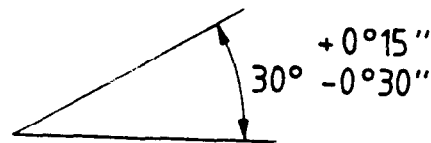


FIG. 12.14

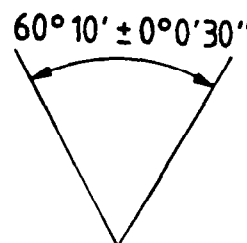


FIG. 12.15

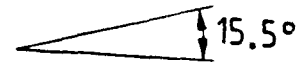


FIG. 12.16



FIG. 12.17

SECTION 13 METHODS OF DIMENSIONING AND TOLERANCING CONES

13.1 Scope – This section specifies methods of dimensioning and tolerancing cones on drawings.

diameters of two sections of a cone to their distance.

13.2 Definitions and Symbols

$$\text{Thus taper } C = \frac{D - d}{L} = 2 \tan \frac{\alpha}{2}$$

13.2.1 Taper – The ratio of the difference in the

(see Fig. 13.1).

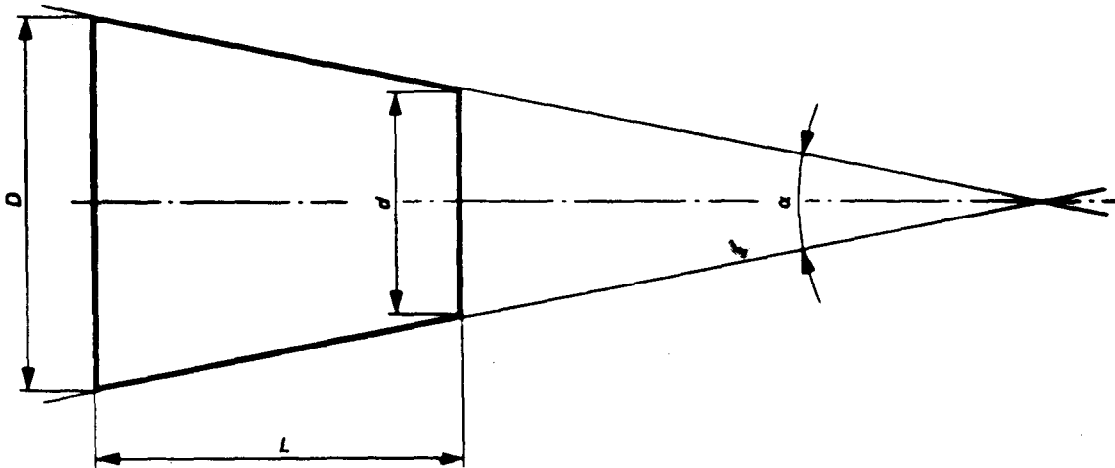


FIG. 13.1

13.2.2 The following symbol indicates a taper and, correctly oriented, may be used to show the direction of the taper (see below).



NOTE – Taper (as defined above) shall not be confused with slope.

Slope, which is not the subject of this guide, is the inclination of the line representing the inclined surface of a wedge expressed as the ratio of the differences in the heights at right angles to the base line, at a specified distance apart, to that distance.

$$\text{Thus slope} = \frac{H - h}{L} = \tan B \text{ (see Fig. 13.2).}$$

If necessary the following symbol for slope may be used to show the direction of the slope :

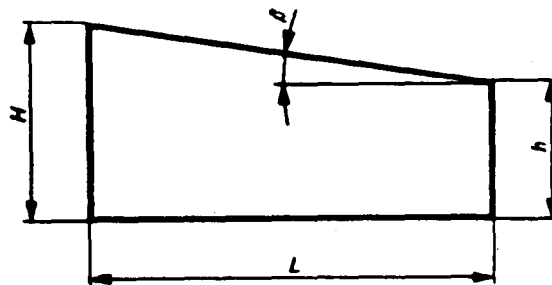


FIG. 13.2

13.3 Dimensioning

13.3.1 The following dimensions may be used, in different combinations, to define the size, form and position of cones:

- a) the taper, specified either by the included angle or as a ratio, for example:
 - 0.3 rad
 - 35°
 - 1:5
 - 0.2:1
 - 20 % (see Fig. 13.10)

- b) the diameter at the larger end;
- c) the diameter at the smaller end;
- d) the diameter at a selected cross-section, this cross-section may be within or outside the cone;
- e) the dimension locating a cross-section at which the diameter is specified;
- f) the length of the cone.

Figures 13.3 to 13.6 show some typical combinations of dimensions.

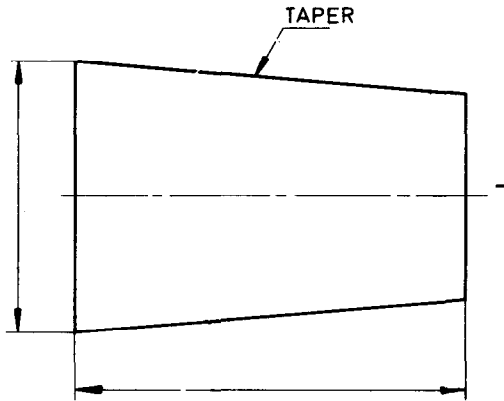


FIG. 13.3

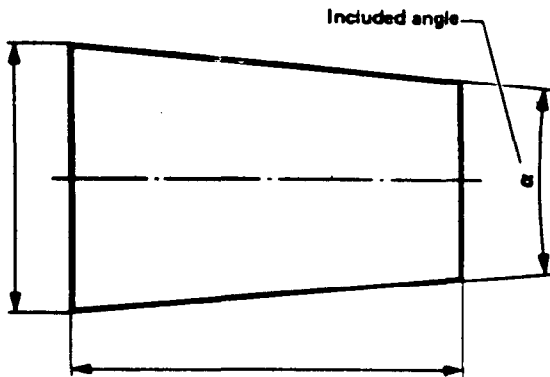


FIG. 13.4

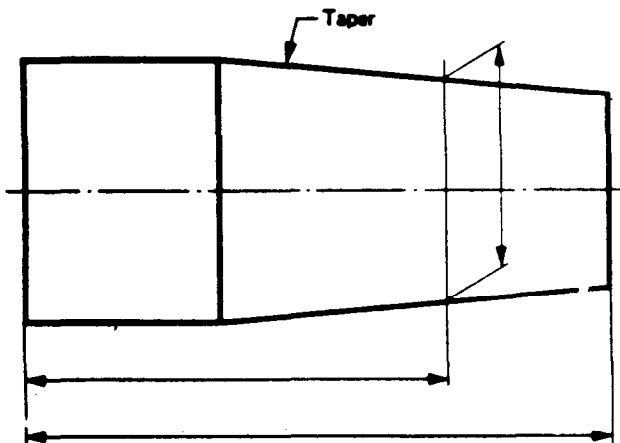


FIG. 13.5

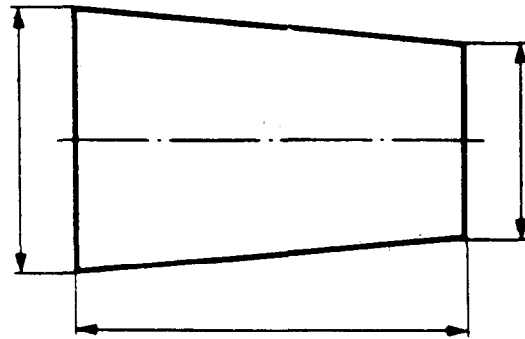


FIG. 13.6

13.3.2 No more of these dimensions than are necessary shall be specified. However, additional dimensions may be given as "auxiliary" dimensions in brackets for information, for example half the included angle.

13.3.3 When a taper of standardized series is concerned (in particular morse or metric taper) the tapered feature may be designated by specifying the standard series and appropriate number.

13.4 Tolerancing

13.4.1 General

13.4.1.1 There are two methods of specifying the accuracy of cones, namely, basic taper method and toleranced taper method. In this publication, only basic taper method has been explained.

13.4.1.2 On the right-hand side of the figures, the tolerance zones are shown.

13.4.1.3 It should be noted that errors of form may exist, provided that every part of the surface lies inside the tolerance zone. In practice it may not be permitted to absorb the whole of the tolerance zone by errors of form. When restrictions in this regard are necessary this shall be indicated by appropriate tolerances of form.

13.4.1.4 The datum dimensions (which may be linear or angular) and the toleranced sizes define the tolerance zone within which the conical surface shall be contained.

13.4.1.5 A datum dimension (enclosed in a frame) is a dimension which defines the exact location of a point, line, plane or conical surface, the real position of which is controlled by means other than by direct tolerancing of this dimension.

13.4.1.6 It may be used to define the exact position of a cross section of a cone at which the diameter is allowed to vary within specified limits. It may also be used to define the exact diameter of a

cross section of a cone the position of which is variation of penetration of mating surfaces each

13.4.1.7 It should be noted that where the method of dimensioning shown in Fig. 13.8 and 13.9 is used, either the diameter or the position will be a datum dimension (enclosed in a frame).

13.4.1.8 The choice of the tolerancing method and of the values of the tolerances depends on the functional requirements.

13.4.2 Basic Taper Method

13.4.2.1 In this method the tolerances limit the

profiles of the same taper corresponding to the maximum and minimum material conditions.

13.4.2.2 The tolerance zone limiting the cone is established by a tolerance either on diameter or on position.

By convention the prescribed or resulting tolerances of the diameter of the feature applies at all cross sections throughout its length (see Fig. 13.7 to 13.9).

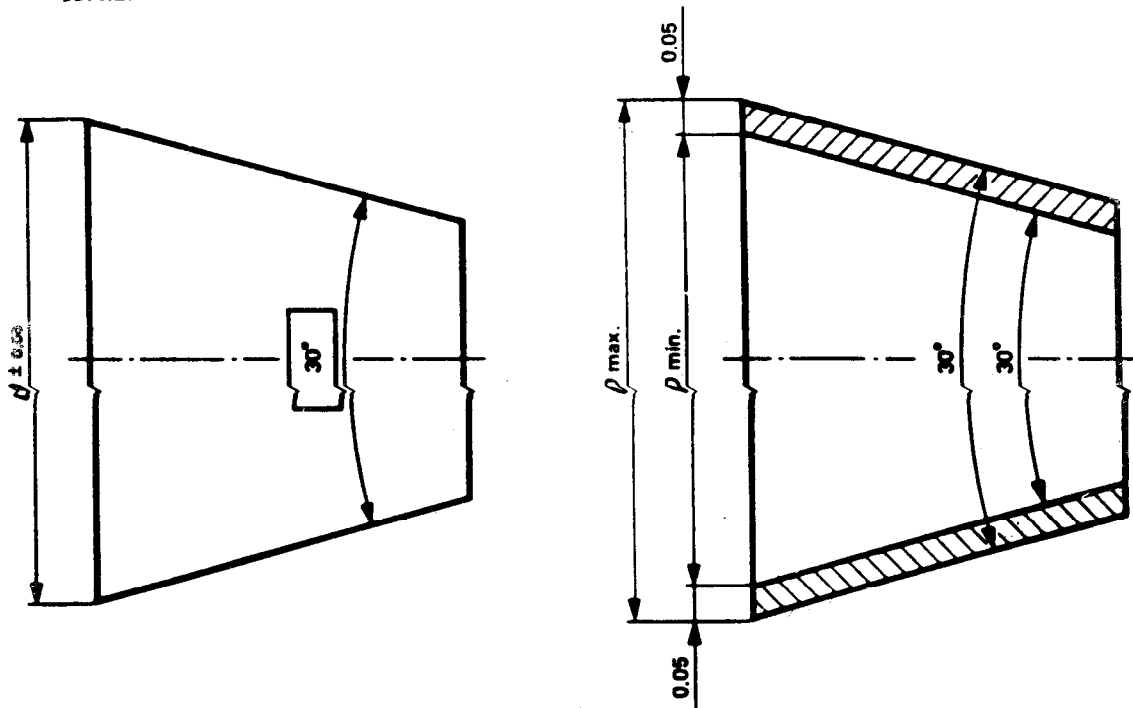


FIG. 13.7

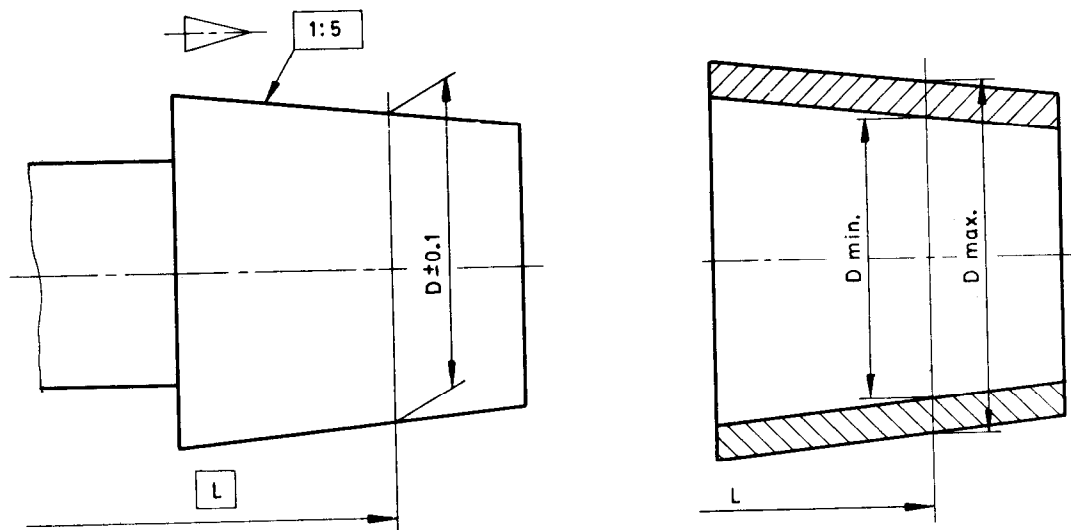


FIG. 13.8

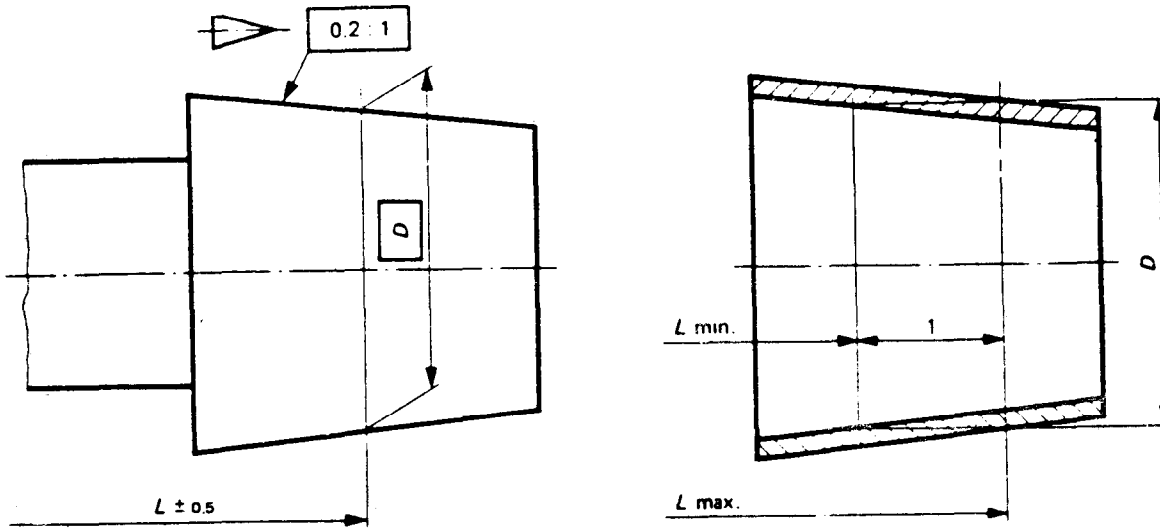


FIG.13.9

13.4.2.3 The surface of cone may lie anywhere within the tolerance zone (see also 13.4.1.3).

13.4.2.4 Figure 13.7 illustrates a cone dimensioned by the basic taper method and where the size at one end of the feature is specified by a toleranced dimension.

13.4.2.5 Figure 13.8 illustrates a cone dimensioned by the basic taper method and where the size is controlled by a toleranced dimension at a cross section located by a datum dimension enclosed in a frame.

13.4.2.6 Figure 13.9 illustrates a cone dimensioned by the basic taper method and where the diameter of a cross-section is a datum dimension. This cross-section is located within specified limits in

13.4.2.7 The basic taper method according to Fig. 13.7, 13.8 or 13.9 may not be suitable for use in cases where the variation in taper, arising from the necessary tolerances on diameter or position would not be acceptable. This may be overcome by the use of Fig. 13.10.

13.4.2.8 Where it is necessary to apply restrictive conditions limiting the effective variation of the taper within the tolerance zone, the following methods shall be used:

- a) By a reference to a written note specifying the permissible limit of the actual taper;
- b) By indicating a restrictive angularity tolerance to the generating lines with respect to the axis (see Fig. 13.10).

NOTE - The tolerance zone for angularity (including straightness) may lie anywhere within the tolerance zone

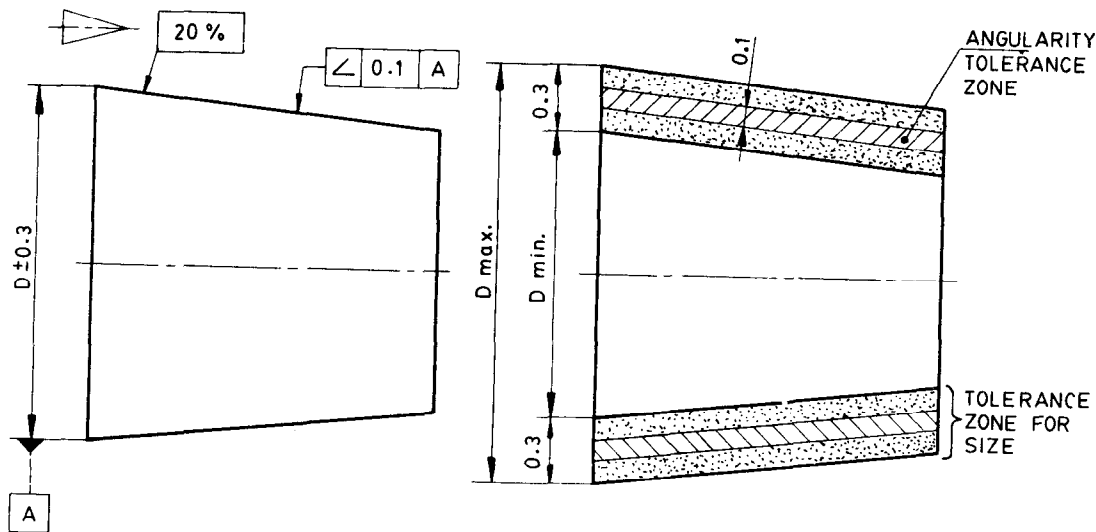


FIG.13.10

SECTION 14 METHOD OF INDICATING SURFACE TEXTURE ON TECHNICAL DRAWINGS

14.1 Scope – This section specifies the symbols and additional indications of surface texture to be indicated on technical drawings.

14.2 Symbols used for Indication of Surface Texture

14.2.1 The basic symbol consists of two legs of unequal length inclined at approximately 60° to the line representing the considered surface, as shown in Fig. 14.1.

14.2.1.1 This symbol alone has no meaning except as in 14.4.4 and 14.4.7.

14.2.2 If the removal of material by machining is required, a bar is added to the basic symbol, as shown in Fig. 14.2.

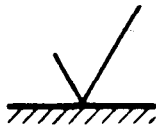


FIG. 14.1



FIG. 14.2

14.2.3 If the removal of material is not permitted, a circle is added to the basic symbol, as shown in Fig. 14.3.

14.2.4 The symbol in Fig. 14.3 may also be used in a drawing relating to a production process to indicate that a surface is to be left in the state resulting from a preceding manufacturing process, whether this state was achieved by removal of material or otherwise.

14.2.4.1 In this case none of the indications given in 14.3 are added to the symbol.

14.2.5 When special surface characteristics have to be indicated, a line is added to the longer arm of any of the above symbols, as shown in Fig. 14.4.

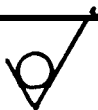


FIG. 14.3

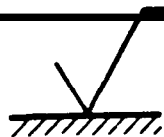


FIG. 14.4

14.3 Indications Added to the Symbols

14.3.1 Indication of Surface Roughness

14.3.1.1 The value or values defining the principal criterion of roughness are added to the symbols given in Fig. 14.1, 14.2 and 14.3, as shown in Fig. 14.5, 14.6 and 14.7.

14.3.1.2 A surface texture specified:

- as in Fig. 14.5 may be obtained by any production methods.
- as in Fig. 14.6 shall be obtained by removal of material by machining, and
- as in Fig. 14.7 shall be obtained without removal of material.

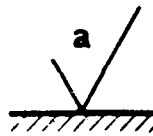


FIG. 14.5

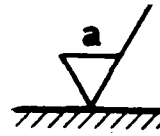


FIG. 14.6

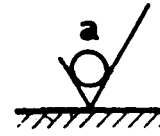


FIG. 14.7

14.3.1.3 When only one value is specified it represents the maximum permissible value of surface roughness.

14.3.1.4 If it is necessary to impose maximum and minimum limits of the principal criterion of surface roughness, both values shall be shown as in Fig. 14.8 with the maximum limit (a_1) above the minimum limit (a_2).

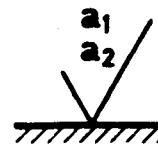


FIG. 14.8

14.3.1.5 The principal criterion of roughness, R_a may be indicated by the corresponding roughness grade number shown in Table 14.1.

14.3.2 Indication of Special Surface Texture Characteristics

14.3.2.1 In certain circumstances, for functional reasons, it may be necessary to specify additional special requirements concerning surface texture.

14.3.2.2 If it is required that the final surface texture be produced by one particular production method, this method shall be indicated in plain

language on an extension of the longer arm of the symbol given in Fig. 14.4 as shown in Fig. 14.9.

TABLE 14.1

Roughness Values R_a	Roughness Grade Numbers
μm	
(1)	(2)
50	N 12
25	N 11
12.5	N 10
6.3	N 9
3.2	N 8
1.6	N 7
0.8	N 6
0.4	N 5
0.2	N 4
0.1	N 3
0.05	N 2
0.025	N 1

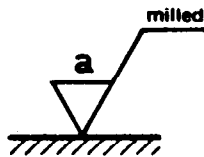


FIG. 14.9

14.3.2.3 Also on this extension line shall be given any indications relating to treatment or coatings.

Unless otherwise stated, the numerical value of the roughness applies to the surface texture after treatment or coating.

If it is necessary to define surface texture both before and after treatment, this shall be explained in a suitable note or in accordance with Fig. 14.10.

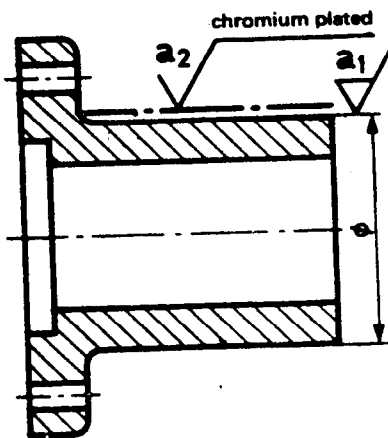


FIG. 14.10

14.3.2.4 If it is necessary to indicate the sampling length, it shall be selected from the series given in IS:3073-1967 'Assessment of surface roughness', and be stated adjacent to the symbol as shown in Fig. 14.11.

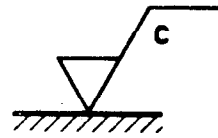


FIG. 14.11

14.3.2.5 If it is necessary to control the direction of lay, it is specified by a symbol (see 14.3.3) added to the surface texture symbol as shown in Fig. 14.12.

NOTE - The direction of lay is the direction of the predominant surface pattern, ordinarily determined by the production method employed.

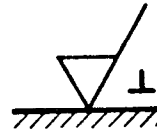


FIG. 14.12

14.3.3 Symbols for the Direction of Lay - The series of symbols shown in Table 14.2 specifies the common directions of lay.

14.3.4 Indication of Machining Allowance - Where it is necessary to specify the value of the machining allowance, this shall be indicated on the left of the symbols as shown in Fig. 14.13. This value shall be expressed in millimetres according to the general system used for dimensioning the drawing.

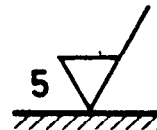
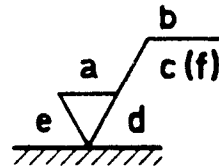


FIG. 14.13

14.3.5 Position of the Specifications of the Surface Texture in the Symbol - The specifications of surface texture shall be placed relative to the symbol as shown in Fig. 14.14.



a = Roughness value R_a in micrometres
or
= Roughness grade number N1 to N12.

b = Production method, treatment or coating
 c = Sampling length
 d = Direction of lay
 e = Machining allowance
 f = Other roughness values (in brackets).

FIG. 14.14

14.4 Indications on Drawings

14.4.1 In conformity with Section 11, the symbol, as well as the inscriptions, shall be oriented so that they may be read from the bottom or the right hand side of the drawing (see Fig. 14.15).

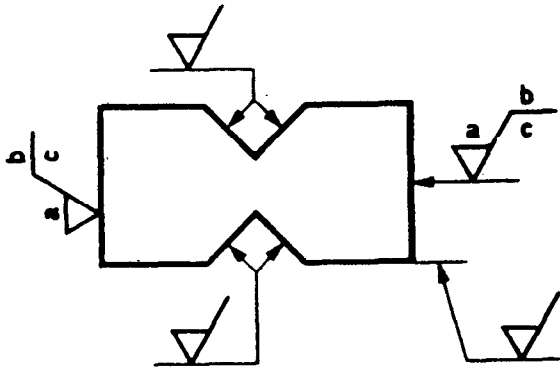


FIG. 14.15

14.4.1.1 If it is not practicable to adopt this general rule, the symbol may be drawn in any position, but only provided that it does not carry any indications of special surface texture characteristics or of machining allowances. Nevertheless, in such cases the inscription defining the value of the principal criterion of roughness (if present) shall always be written in conformity with the general rule (see Fig. 14.16).

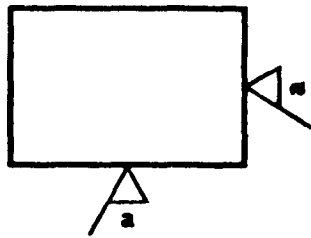


FIG. 14.16

14.4.1.2 If necessary, the symbol may be connected to the surface by a leader line terminating in an arrow.

14.4.1.3 The symbol or the arrow shall point from outside the material of the piece, either to the line representing the surface or to an extension of it (see Fig. 14.15).

14.4.2 In accordance with the general principles of dimensioning, the symbol is only used once for a given surface and, if possible, on the view which carries the dimension defining the size or position of the surface (see Fig. 14.17).

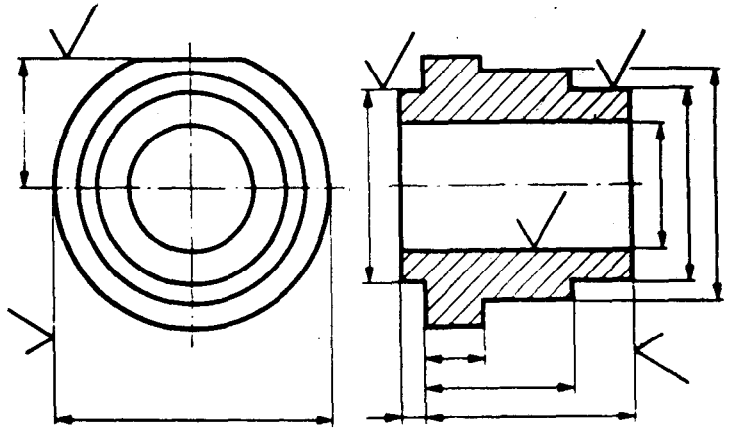


FIG. 14.17

14.4.3 If the same texture is required on all the surfaces of a part, it is specified:

- either by a note near a view of the part (Fig. 14.18), near the title block, or in the space devoted to general notes;
- or following the part number on the drawing (Fig. 14.19).

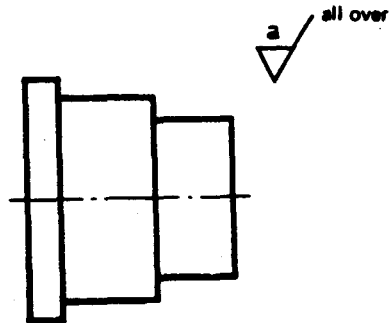


FIG. 14.18

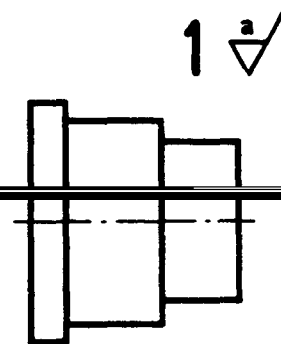
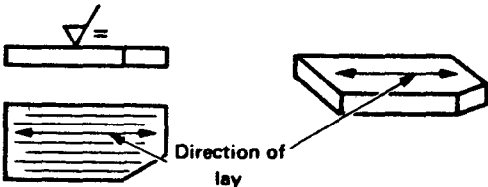
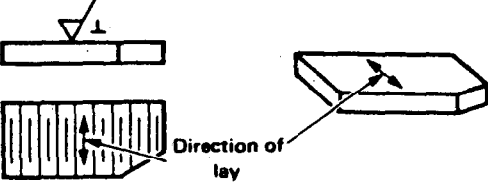
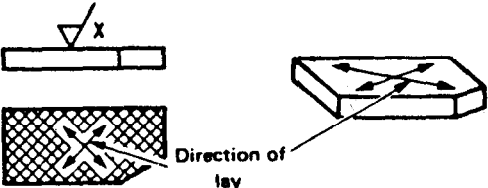
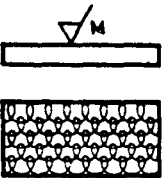
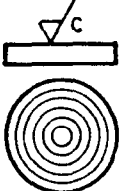
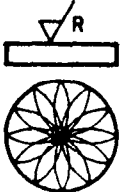


FIG. 14.19


TABLE 14.2

Symbol	Interpretation
<p>=</p>	<p>Parallel to the plane of projection of the view in which the symbol is used</p> 
<p>⊥</p>	<p>Perpendicular to the plane of projection of the view in which the symbol is used</p> 
<p>X</p>	<p>Crossed in two slant directions relative to the plane of projection of the view in which the symbol is used</p> 
<p>M</p>	<p>Multi-directional</p> 
<p>C</p>	<p>Approximately circular relative to the centre of the surface to which the symbol is applied</p> 
<p>R</p>	<p>Approximately radial relative to the centre of the surface to which the symbol is applied</p> 

NOTE - Should it be necessary to specify a direction of lay not clearly defined by these symbols then this must be achieved by a suitable note on the drawing.

14.4.4 If the same surface texture is required on the majority of the surfaces of a part, it is specified as in 14.4.3 with the addition of :

- the notation "except where otherwise stated" (Fig. 14.20).
- or a basic symbol (in brackets) without any other indication (Fig. 14.21).

a_1 /  all over
except where otherwise stated

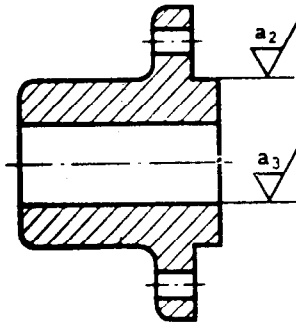



FIG. 14.20

2 a_1 / ()

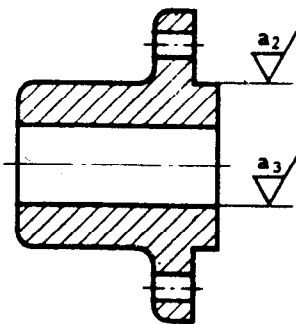


FIG. 14.21

14.4.5 The symbols for the surface textures which are exceptions to the general symbol are indicated on the corresponding surfaces.

14.4.6 To avoid the necessity of repeating a complicated specification a number of times, or where space is limited, a simplified specification may be used on the surface, provided that its meaning is explained near the drawing of the part, near the title block or in the space devoted to general notes (see Fig. 14.23).

14.4.7 If the same surface texture is required on a large number of surfaces of the part, one of the

2 a_1 / (a_2 / a_3 /)

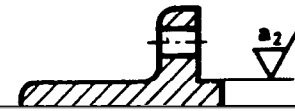


FIG. 14.22

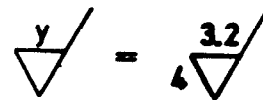
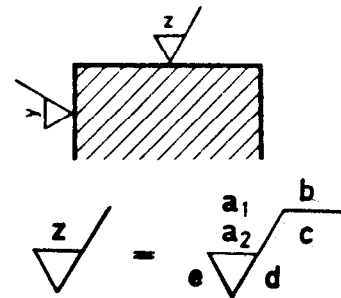


FIG. 14.23

symbols shown in Fig. 14.1, 14.2 or 14.3 may be used on the appropriate surfaces and its meaning given on the drawing, for example, as shown in Fig. 14.24, 14.25 and 14.26.

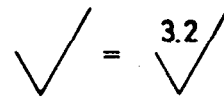


FIG. 14.24

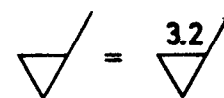


FIG. 14.25

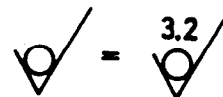


FIG. 14.26

14.5 Important Notes

14.5.1 Only give indications of the roughness, method of production or machining allowance in so far as this is necessary to ensure fitness for purpose and only for those surfaces which require it.

14.5.2 The specification of surface texture is unnecessary whenever the ordinary manufacturing processes by themselves ensure an acceptable surface finish.

14.6 Synoptic Tables

14.6.1 Symbols with No Inscription



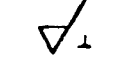
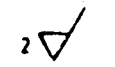
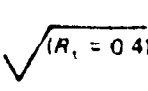
	Symbol	Meaning
14.6.1.1	✓	Basic symbol. It may only be used alone when its meaning is explained by a note.
14.6.1.2	▽	A machined surface with no indication of any other detail.
14.6.1.3	⊖	A surface from which the removal of material is prohibited. This symbol may also be used in a drawing relating to a production process to indicate that a surface is to be left in the state resulting from a preceding manufacturing process, whether this state was achieved by removal of material or otherwise.

14.6.2 Symbols with indication of the Principal Criterion of Roughness, R_a


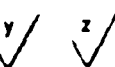
	Symbol			Meaning
	Removal of Material by machining is			
	optional	obligatory	prohibited	
14.6.2.1	$\frac{3.2}{\checkmark}$ or $\frac{N8}{\checkmark}$	$\frac{3.2}{\nabla}$ or $\frac{N8}{\nabla}$	$\frac{3.2}{\ominus}$ or $\frac{N8}{\ominus}$	A surface with a maximum surface roughness value R_a of 3.2 μm
14.6.2.2	$\frac{6.3}{\checkmark}$ or $\frac{N9}{\checkmark}$ $\frac{1.6}{\checkmark}$ or $\frac{N7}{\checkmark}$	$\frac{6.3}{\nabla}$ or $\frac{N9}{\nabla}$ $\frac{1.6}{\nabla}$ or $\frac{N7}{\nabla}$	$\frac{6.3}{\ominus}$ or $\frac{N9}{\ominus}$ $\frac{1.6}{\ominus}$ or $\frac{N7}{\ominus}$	A surface with a maximum surface roughness value R_a of 6.3 μm and a minimum of 1.6 μm

14.6.3 Symbols with Additional Indications

(May be used singly, in combination or combined with an appropriate symbol from 14.6.2).

	<i>Symbol</i>	<i>Meaning</i>
14.6.3.1		Production method: milled.
14.6.3.2		Sampling length: 2.5 mm
14.6.3.3		Direction of lay: perpendicular to the plane of projection of the view.
14.6.3.4		Machining allowance: 2 mm
14.6.3.5		Indication (in brackets) of a criterion of roughness other than that used for R_a for example $R_t = 0.4 \mu\text{m}$

14.6.4 Simplified Symbols

	<i>Symbol</i>	<i>Meaning</i>
14.6.4.1		A note indicates the meaning of the symbol.
14.6.4.2		A note indicates the meaning of the symbols.

NOTE: - The surface texture values, production method, sampling length, direction of lay and machining allowance quoted are typical values and are only given as examples.

SECTION 15 TECHNICAL DRAWINGS FOR STRUCTURAL METAL WORK

15.1 Scope This section specifies complementary **15.2 Representation of Holes, Bolts and Rivets**

and dimensioning (Section 11), necessary for assembly and detail drawings concerning:

- structural metal work consisting of plates and sheets, profile sections and compound elements (including bridges, frameworks, pilings) etc);
- lifting and transport appliances;
- storage tanks and pressure vessels;
- lifts, moving stairways and conveyor belts;
- etc.

15.2.1 Representation on Projection Planes Normal to Their Axes

15.2.1.1 In order to represent holes, bolts and rivets on projection planes normal to their axes, the following symbols, represented in thick lines, shall be used (Table 15.1 and 15.2).

15.2.1.2 The symbol for holes shall be without a dot in the centre.

TABLE 15.1

Hole	Symbol for hole			
	without countersinking	countersunk on near side	countersunk on far side	countersunk on both sides
drilled in the workshop	+	✳	✳	✳
drilled on site	✳	✳	✳	✳

TABLE 15.2

Bolt or Rivet	Symbol for bolt or rivet to fit in Hole			Symbol for rivet to fit in Hole Countersunk on Both Sides
	Without Countersinking	Countersunk on Near Side	Countersunk on Far Side	
Fitted in the workshop	✳	✳	✳	✳
Fitted on site	✳	✳	✳	✳
Fitted on site and hole drilled on site	✳	✳	✳	✳

NOTE - To distinguish bolts from rivets, the designation of bolts shall always begin with a prefix showing the type of screw thread. (Example : the designation for a bolt with metric screw thread is M 12 x 50, whilst that for a rivet is ϕ 12 x 50).

15.2.2 Representation on Projection Planes Parallel to Their Axes – In order to represent holes, bolts and rivets on projection planes parallel to their axes, the symbols of the following representations shall be adopted (Tables 15.3 and 15.4). Only the horizontal dash of these symbols shall be represented in thin line, while all other parts shall be represented in thick line.

TABLE 15.3

Hole	Symbol for Hole		
	Without Countersinking	Countersunk on One Side Only	Countersunk on Both Sides
Drilled in the Workshop			
Drilled on Site			

TABLE 15.4

Bolt or rivet	Symbol for bolt or rivet to fit in hole		Symbol for rivet to fit in hole countersunk on both sides	Symbol for bolt with designated nut position
	without countersinking	countersunk on one side only		
fitted in the workshop				
fitted on site				
fitted on site and hole drilled on site				

NOTE – To distinguish bolts from rivets, the designation of bolts shall always begin with a prefix showing the type of screw thread. (Example : the designation for a bolt with metric screw thread is M 12 X 50, whilst that for a rivet is ϕ 12 X 50.)

15.2.3 Dimensioning and Designation

NOTE – Because, in practice, the dimension lines and the projection lines are drawn with the same drawing instrument, a short thin line, drawn at 45° to the dimension line, has been used to represent the terminations of dimension lines.

15.2.3.1 The projection lines shall be separated from the symbols of holes, bolts and rivets on projection planes parallel to their axes (see Fig. 15.1).

15.2.3.2 The diameter of holes shall be indicated at the side of the symbol (see Fig. 15.3).

15.2.3.3 To indicate the characteristics of bolts and rivets the designation shall be given in accordance with national standards or other specifications in use (see Fig. 15.2).

15.2.3.4 The designation of holes, bolts and rivets, when referred to groups of identical elements, can be restricted to one exterior element (see Fig. 15.2).

In this case the designation shall be preceded by the number of holes, bolts, rivets constituting the group (see Fig. 15.2 and 15.3).

15.3 Dimensioning of Chamfers – Chamfers shall be defined by means of linear dimensions as shown in Fig. 15.4 A and 15.4 B.

15.4 Dimensioning and Lengths of Arcs – At the side of the developed lengths of arcs, the bending radius to which these lengths refer shall be indicated in brackets (external fibre, centroidal fibre, etc) as shown in Fig. 15.5 and 15.6.

15.5 Designation of Bars, Profile Sections, Plates and Sheets

15.5.1 Bars and Profile Sections – Symbols and dimensions indicated in Table 15.5 shall be applied. The designation on drawing shall be adapted to the position of bar or profile section (see Fig. 15.1, 15.5, 15.6 and 15.7).

15.5.2 Plates and Sheets – Plates and sheets shall be designated by their thickness followed by the overall finished dimensions of the enclosing rectangle (see Fig. 15.7, 15.8 and 15.9).

15.6 Dimensioning of Gusset Plates

15.6.1 The reference system for dimensioning a gusset shall be made up by at least two converging centroidal lines with a defined angular position. Their

as shown in Fig. 15.5 and 15.6.

holes, referred to the above mentioned centroidal lines, the overall dimensions and the minimum distance between the edges of the gusset plates and

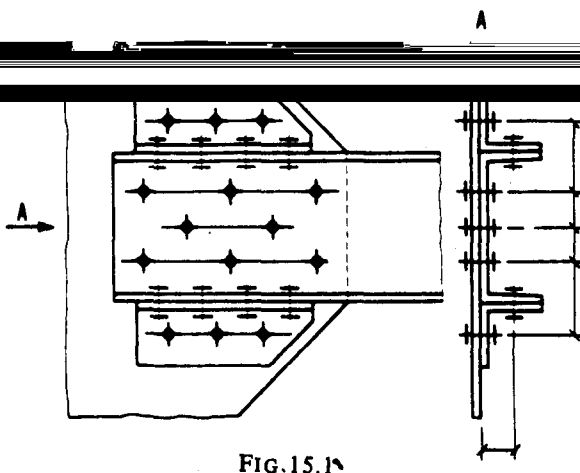


FIG. 15.1

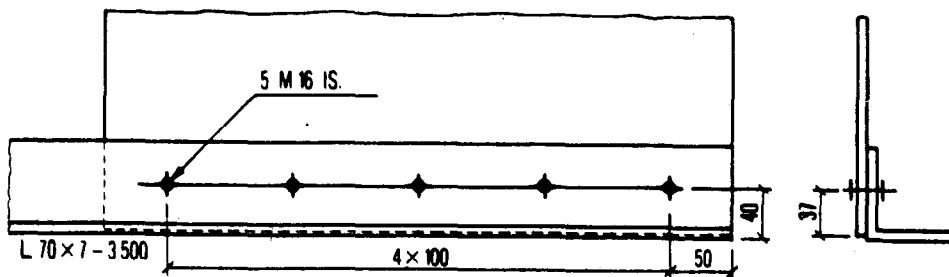


FIG. 15.2

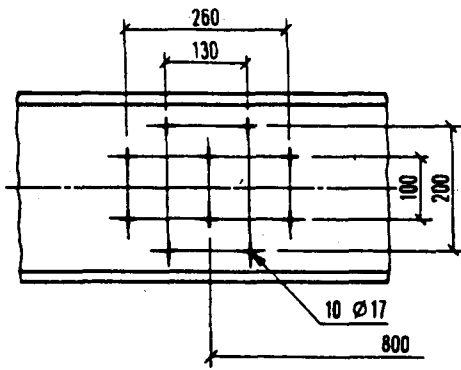


FIG. 15.3

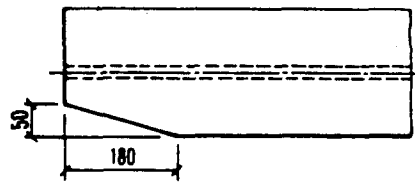


FIG 15.4 A

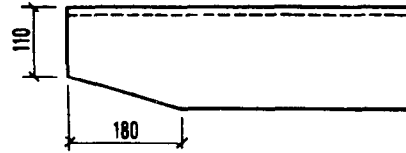


FIG. 15.4 B

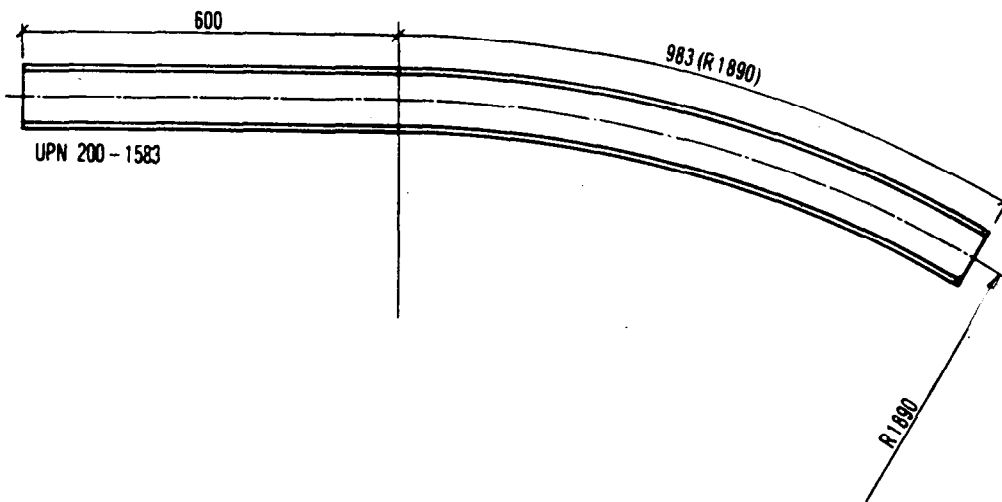


FIG 15.5

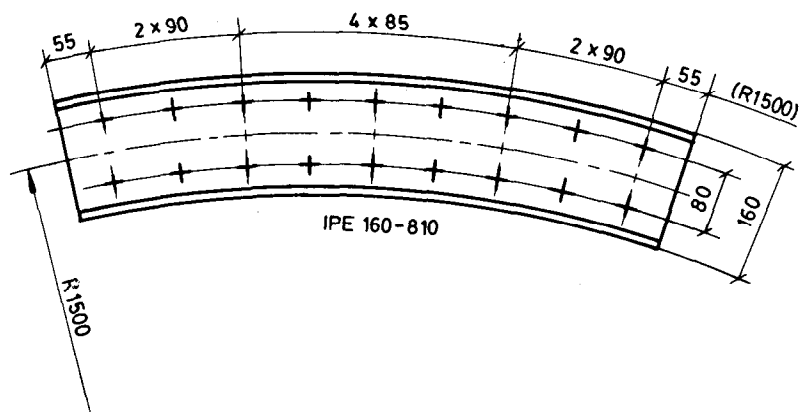


FIG. 15.6

TABLE 15.5






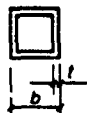


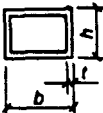







Description	Designation		Signification of dimensions
	Symbol	Dimensions	
Circular solid section		d	
Tube		$d \times t$	
Square solid section		b	
Square hollow section		$b \times t$	
Rectangular solid section		$b \times h$	
Rectangular hollow section		$b \times h \times t$	
Hexagonal solid section		s	
Hexagonal hollow section		$s \times t$	
Triangular solid section		b	
Semi-circular solid section		$b \times h$	

TABLE 15.5 (Concluded)

Description	Designation		Signification of dimensions
	Symbol	Dimensions	
Angle section			If there are no National Standards or other relevant standards, profile section dimensions shall be indicated by means of their particular characteristics preceded by the symbol. (Example : L 80 x 60 x 7 - 500)
T-section			
I-beam section			
Channel section			
Z-section			
Rail section			
Bulb angle section			
Bulb flat			

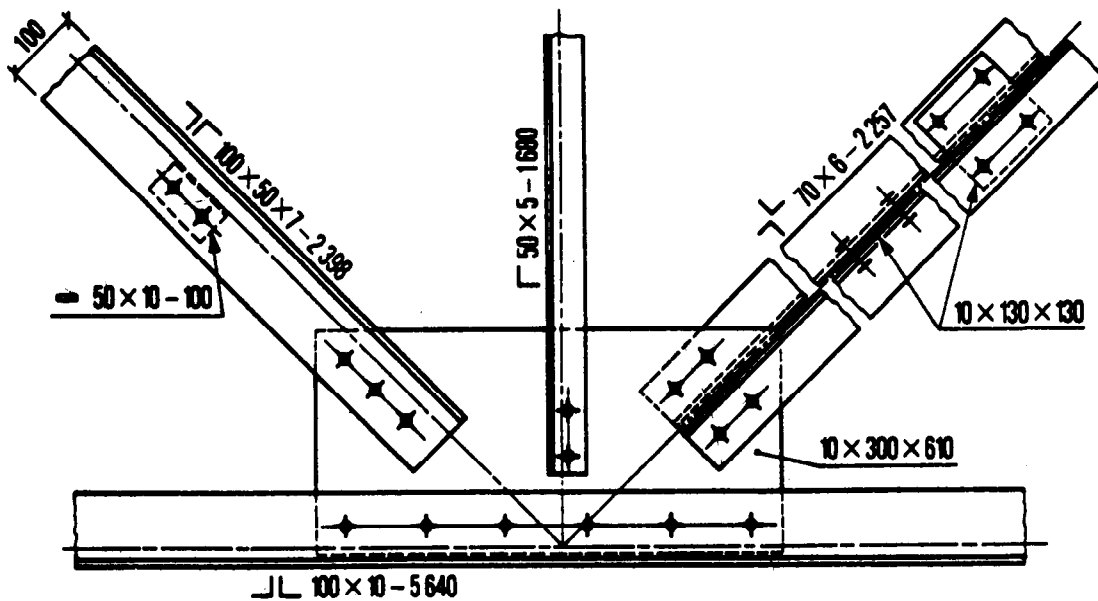


FIG. 15.7

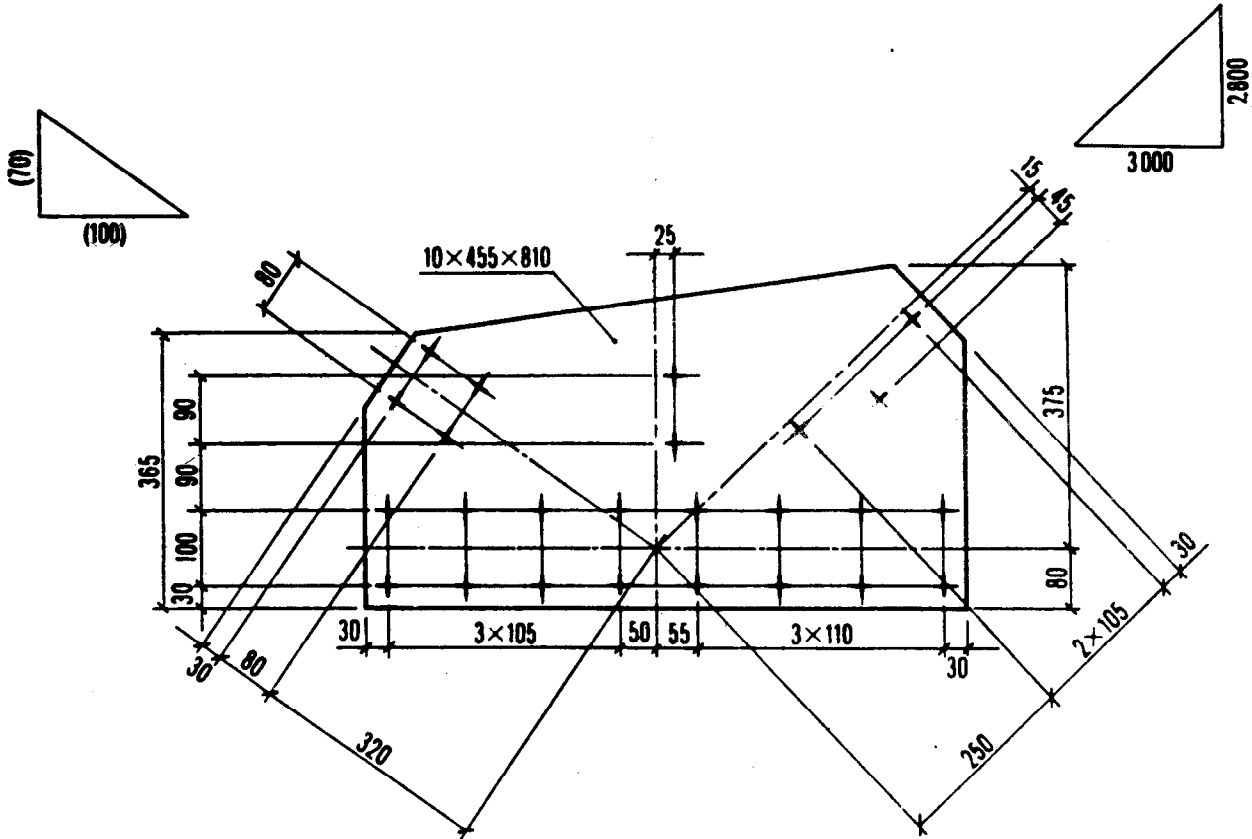


FIG. 15.8

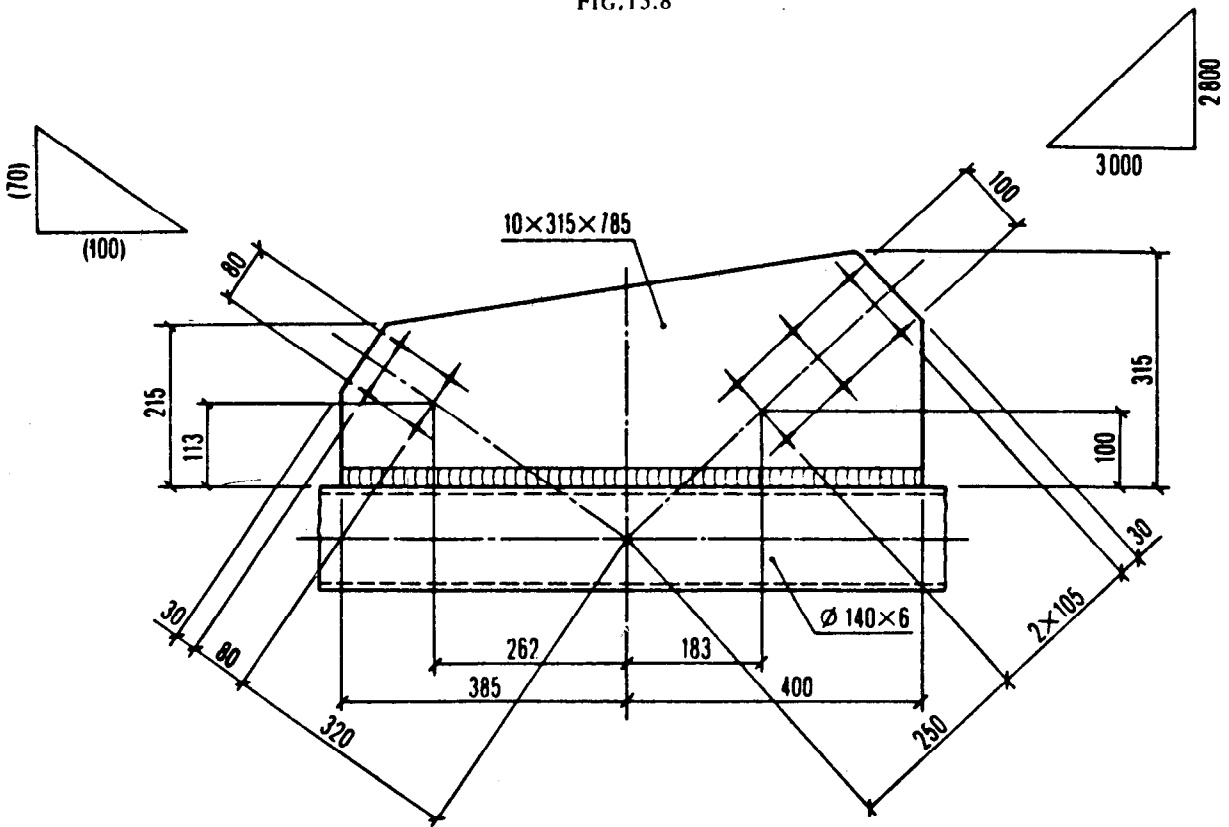


FIG. 15.9

15.7 Diagrammatic Representation

15.7.1 Structural metal work can be represented diagrammatically indicating by continuous thick lines the centroidal lines of the intersecting elements.

15.7.2 In this case, the values of the distances between the reference points of the centroidal lines shall be indicated directly on the represented elements (see Fig. 15.10).

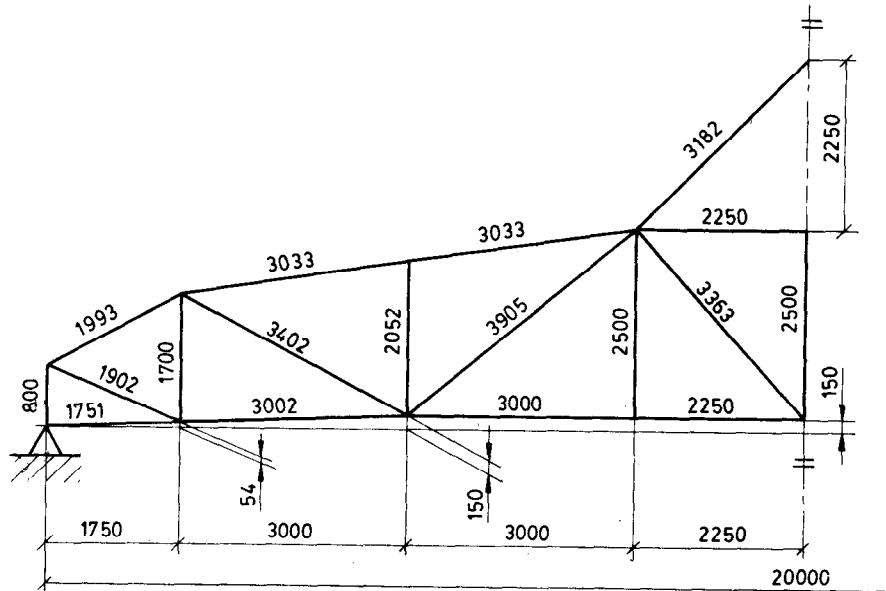


FIG.15.10

SECTION 16 SYMBOLIC REPRESENTATION OF WELDS ON TECHNICAL DRAWINGS

16.1 Scope – This section prescribes the rules to be applied for the symbolic representation of welds on drawings.

16.2 Symbols

16.2.1 Elementary Symbols

16.2.1.1 The various categories of welds are characterized by a symbol which, in general, is similar to the shape of the welds to be made.

16.2.1.2 The symbol shall not be taken to pre-judge the process to be employed.

16.2.1.3 The elementary symbols are shown in Table 16.1.

16.2.2 Combination of Elementary Symbols

16.2.2.1 When required, combination of elementary symbols can be used. Typical examples are given in Table 16.4.

16.2.3 Supplementary Symbols

16.2.3.1 Elementary symbols may be completed by a symbol characterizing the shape of the external surface of the weld.

16.2.3.2 The recommended supplementary symbols are given in Table 16.2.

16.2.3.3 The absence of a supplementary symbol means that the shape of the weld surface does not need to be indicated precisely.

16.2.3.4 Examples of combinations of elementary and supplementary symbols are given in Table 16.3.

NOTE – Though it is not forbidden to associate several symbols, it is better to represent the weld on a separate sketch, when symbolization becomes too difficult.

16.2.3.5 Table 16.3 gives example of application of supplementary symbols.

16.3 Position of the Symbols on Drawings

16.3.1 General – The symbols covered by these rules form only part of a complete method of

representation (Fig. 16.1), which comprises in addition to the symbol (3) itself.

- an arrow line (1) per joint (see Fig. 16.2 and 16.3)
- a dual reference line consisting of two parallel lines; one continuous and one dashed (2) exception (see Note 1); and
- a certain number of dimensions and conventional signs.

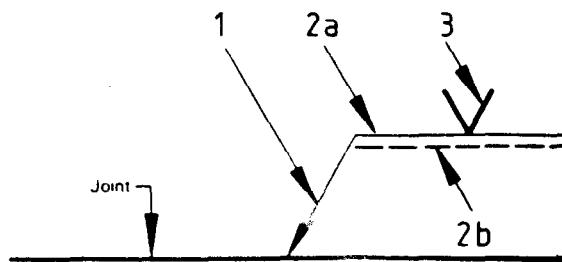


FIG. 16.1 METHOD OF REPRESENTATION

NOTE 1 – The dashed line can be drawn either above or beneath the continuous line (see also 16.3.5).

For symmetrical welds, the dashed line is unnecessary and should be omitted.

NOTE 2 – The thickness of lines for arrow line, reference line, symbol and lettering shall be in accordance with the thickness of line for dimensioning according to Section 6 and 7 respectively.

The purpose of the following rules is to define the location of welds by specifying:

- the position of the arrow line;
- the position of the reference line; and
- the position of the symbol.

16.3.2 Relation Between the Arrow Line and the Joint – The examples given in Fig. 16.2 and 16.3 explain the meaning of the terms:

- “arrow side” of the joint, and
- “other side” of the joint.

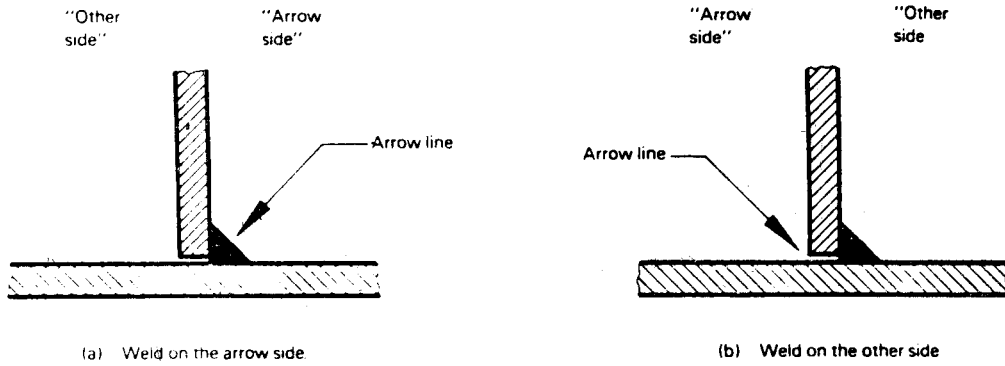


FIG. 16.2 T-JOINT WITH ONE FILLET WELD

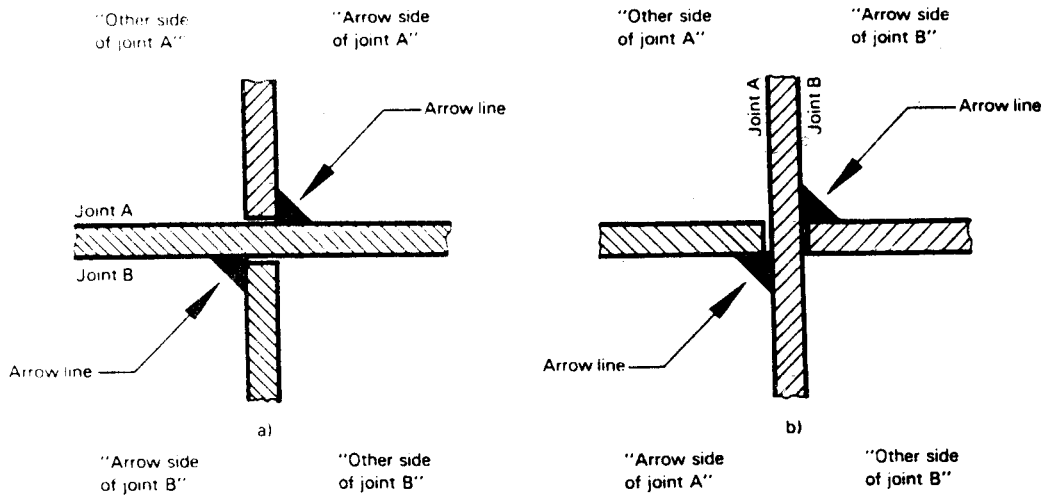


FIG. 16.3 CRUCIFORM JOINT WITH TWO FILLET WELDS

NOTE : The position of the arrow in these sketches is chosen for purposes of clarity. Normally, it would be placed immediately adjacent to the joint.

16.3.3 *Position of the Arrow Line* – The position of the arrow line with respect to the weld is generally of no special significance (see Fig. 16.4 A and 16.4 B). However, in the case of welds of types 4, 6 and 8 (see Table 16.1); the arrow line shall point towards the plate which is prepared (see Fig. 16.4 C and 16.4 D).

The arrow line

- joins one end of the continuous reference line such that it forms an angle with it,
- shall be completed by an arrow head.

16.3.4 *Position of the Reference Line* – The reference line shall preferably be drawn parallel to the

bottom edge of the drawing, or if it is not possible then perpendicular.

16.3.5 *Position of the Symbol with Regard to the Reference Line* – The symbol is to be placed either above or beneath the reference line in accordance with the following regulation:

- the symbol is placed on the continuous line side of the reference line if the weld (weld face) is on the arrow side of the joint (see Fig. 16.5 a).
- the symbol is placed on the dashed line side if the weld (weld face) is on the other side of the joint (see Fig. 16.5 b).

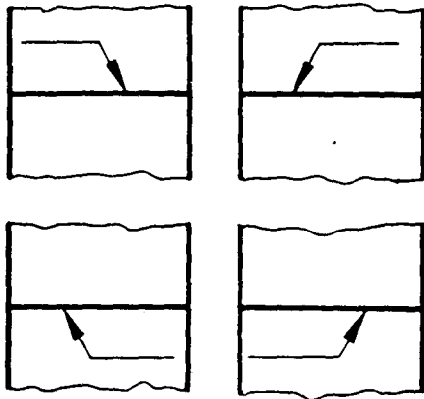


FIG. 16.4 A

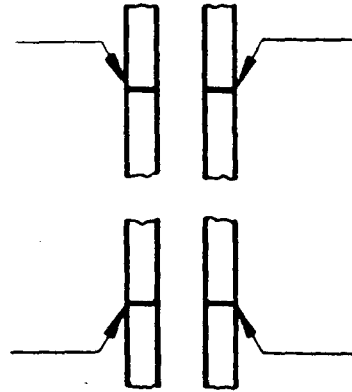


FIG. 16.4 B

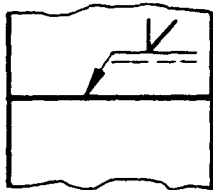


FIG. 16.4 C

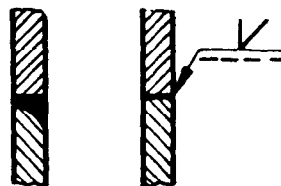
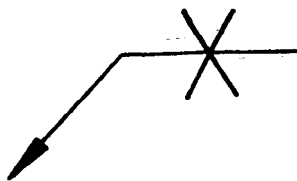


FIG. 16.4 D

FIG. 16.4 POSITION OF THE ARROW LINE

NOTE – In the case of spot welds made by projection welding, the projection surface is to be considered as the external surface of the weld.



For symmetrical welds only

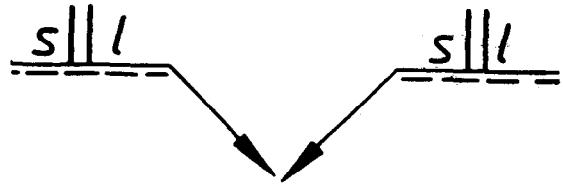


FIG. 16.6. EXAMPLES OF THE PRINCIPLE

16.4.1.4 Other dimensions of less importance may be indicated, if necessary.

16.4.2 Main Dimensions to be Shown

16.4.2.1 The dimension that locates the weld in relation to the edge of the sheet shall not appear in the symbolisation but on the drawing.

16.4.2.2 The absence of any indication following the symbol signifies that the weld is to be continuous over the whole length of the workpiece.

16.4.2.3 In the absence of any indication to the contrary, butt welds are to have complete penetration.

16.4.2.4 For the fillet welds, there are two methods to indicate dimensions (see Fig. 16.7). Therefore, the letters *a* or *z* shall always be placed in front of the value of the corresponding dimension.

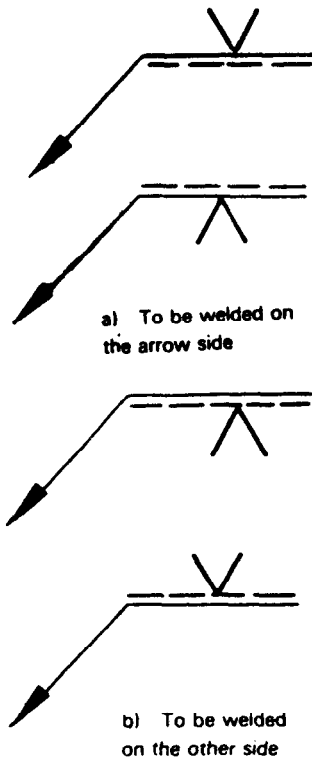


FIG. 16.5

FIG. 16.5 POSITION OF THE SYMBOL ACCORDING TO THE REFERENCE LINE

16.4 Dimensioning of Welds

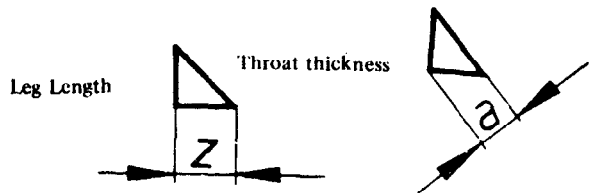
16.4.1 General Rules

16.4.1.1 Each weld symbol may be accompanied by a certain number of dimensions.

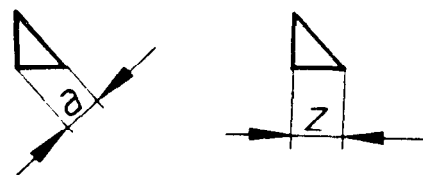
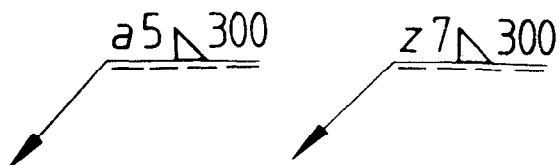
16.4.1.2 These dimensions are written as follows, in accordance with Fig. 16.6:

- a) The main dimensions relative to the cross-section are written on the left-hand side (that means before) of the symbol.
- b) Longitudinal dimensions are written on the right-hand side (that means after) of the symbol.

16.4.1.3 The method of indicating the main dimensions is defined in table 16.5. The rules for setting down these dimensions are also given in this table.












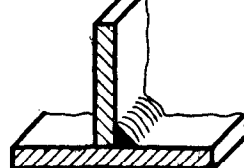
16.4.2.5 In the case of plug or slot welds with bevelled edges, it is the dimension at the bottom of the hole which shall be taken into consideration.



$$z = a\sqrt{2}$$

FIG. 16.7 METHODS OF INDICATING DIMENSIONS FOR FILLET WELDS

TABLE 16.1

No.	Designation	Illustration	Symbol
1	Butt weld between plates with raised edges ¹⁾ ; edge flanged weld /USA/ (the raised edges being melted down completely)		∩
2	Square butt weld		
3	Single-V butt weld		∨
4	Single-bevel butt weld		∟
5	Single-V butt weld with broad root face		Y
6	Single-bevel butt weld with broad root face		Y
7	Single-U butt weld (parallel or sloping sides)		U
8	Single-J butt weld		J
9	Backing run; back or backing weld /USA/		D
10	Fillet weld		△

1) Butt welds between plates with raised edges (symbol 1) not completely penetrated are symbolized as square butt welds (symbol 2) with the weld thicknesses shown (see Table 16.5).

TABLE 16.1 - (Concluded)



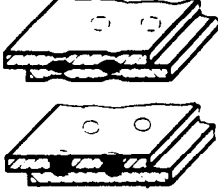

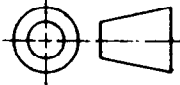
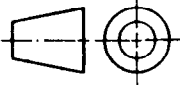


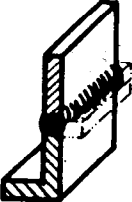

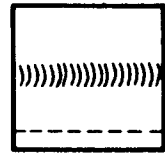
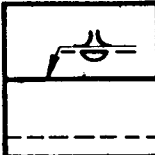
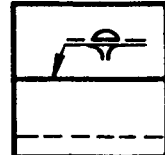
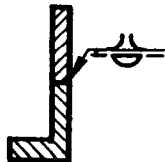
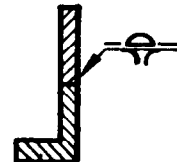

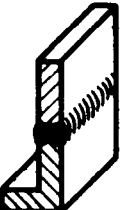

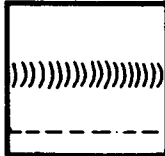
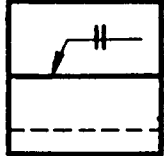
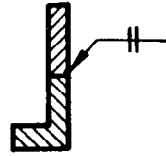

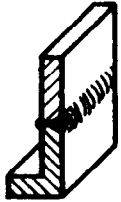

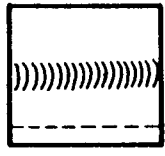
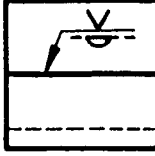
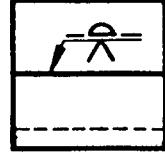
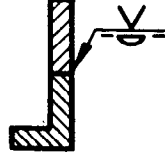
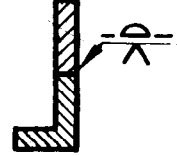

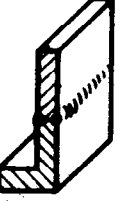

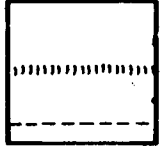
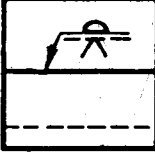
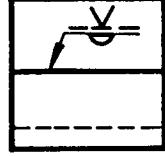
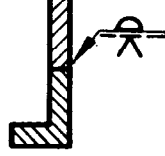
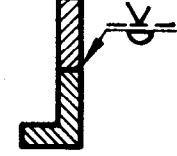
<i>No.</i>	<i>Designation</i>	<i>Illustration</i>	<i>Symbol</i>
11	Plug weld; plug or slot weld /USA/		
12	Spot weld		

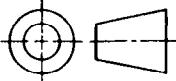
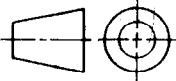

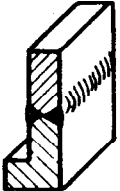

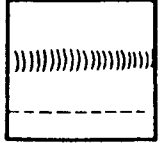
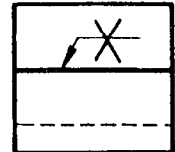
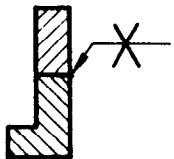

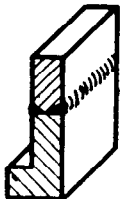

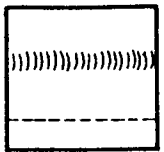
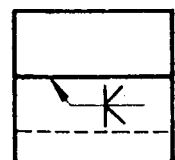
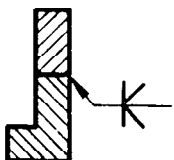
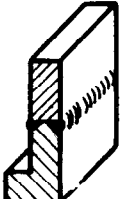

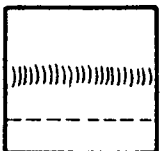
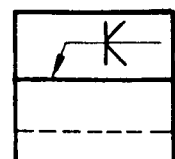
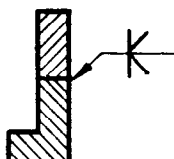

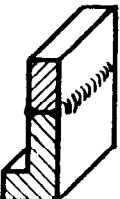

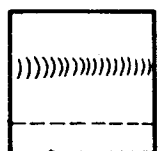
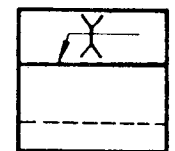
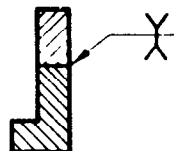

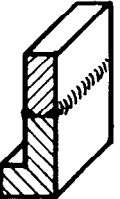

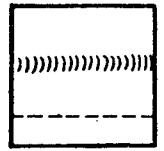
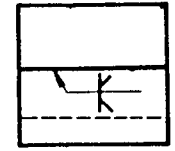
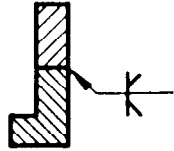
TABLE 16.4 EXAMPLES OF COMBINATION OF ELEMENTARY SYMBOLS

No.	Designation Symbol (Numbers refer to Table 16.1)	Illustration	Representation		Symbolization			
					either	or		
1	Butt weld between plates with raised edges  1 and backing run  9 1-9							
2	Square butt weld  2 welded from both sides 2-2							
3	Single-V butt weld  3 and backing run							
4	 9 3-9							

77

(Continued)

TABLE 16.4 (Continued)

No.	Designation Symbol (Numbers refer to Table 16.1)	Illustration	Representation		Symbolization	
					either	or
5	Double-V butt weld  3 (X weld) 3-3					
6	Double-bevel butt weld  4 (K weld)					
7	4-4					
8	Double-V butt weld with broad root face  5 5-5					
9	Double-bevel butt weld with broad root face  6 6-6					

(Continued)

TABLE 16.4

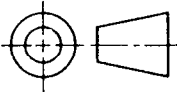
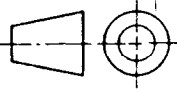




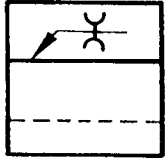
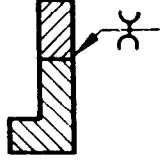

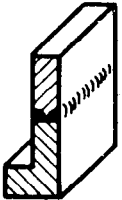

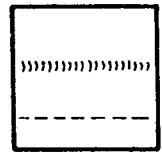
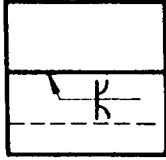
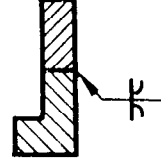


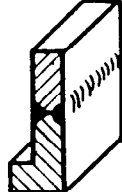


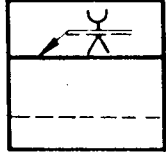
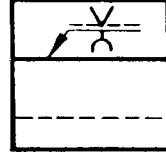
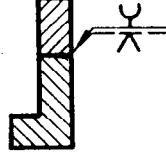
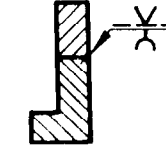

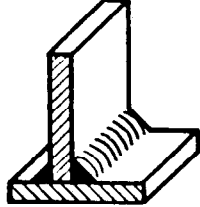
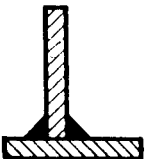
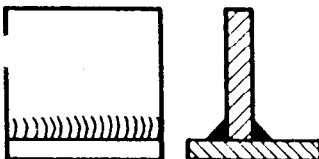
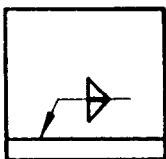
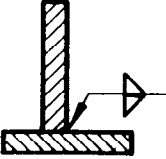

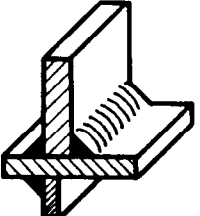
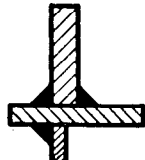
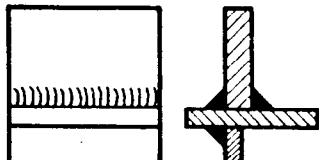
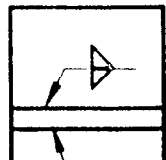
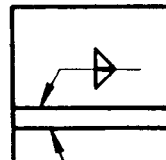
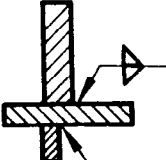
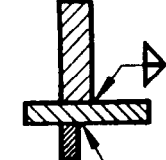
No.	Designation Symbol (Number refer to Table 16.1)	Illustration	Representation		Symbolization	
					either	or
10	Double-U butt weld  7 7-7					
11	Double-J butt weld  8 8-8					
12	Single-V butt weld and single-U butt weld  3  7 3-7				 	 
13	Fillet weld  10 and fillet weld					
14	 10 10-10				 	 

TABLE 16.5 PLAIN DIMENSIONS

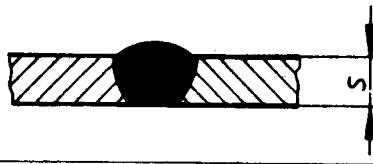

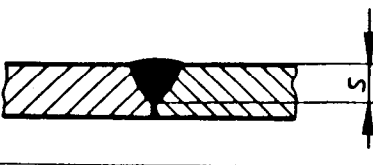

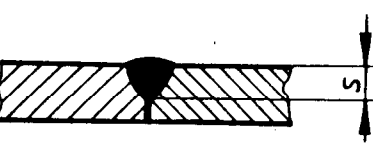

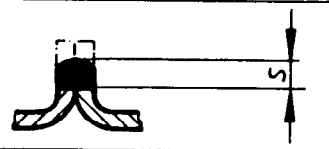

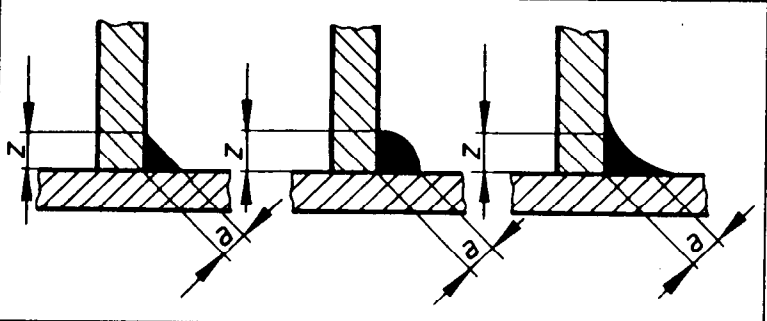


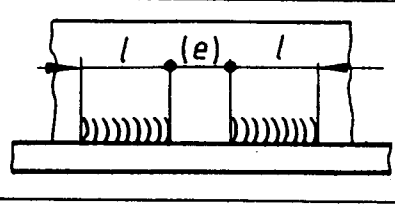


No.	Designation of Welds	Definition	Inscription
1	Butt weld		 see 16.4.2.2 and 16.4.2.3
			s : minimum distance from the surface of the part to the bottom of the penetration, which cannot be greater than the thickness of the thinner part.  see 16.4.2.2
			 see 16.4.2.2
2	Butt weld between plates with raised edges		s : minimum distance from the external surface of the weld to the bottom of the penetration.  see 16.4.2.2 and foot note (1) to Table 16.1
3	Continuous fillet weld		a : height of the largest isosceles triangle that can be inscribed in the section. z : side of the largest isosceles triangle that can be inscribed in the section.   see 16.4.2.2 and 16.4.2.4
4	Intermittent fillet weld		l : length of weld (without end craters). (e) : distance between adjacent weld elements. n : number of weld elements. a } (see No. 3) z }  $n \times l (e)$  $n \times l (e)$ see 16.4.2.4

TABLE 16.5. (Concluded)

No.	Designation of Welds	Definition	Inscription
5	Staggered intermittent fillet weld		$\left. \begin{array}{l} l \\ (e) \\ n \end{array} \right\} \text{ (see No. 4)}$ $\left. \begin{array}{l} a \\ z \end{array} \right\} \text{ (see No. 3)}$ $\frac{a}{a} \triangleright \frac{n \times l}{n \times l} \left[\begin{array}{l} (e) \\ (e) \end{array} \right]$ $\frac{z}{z} \triangleright \frac{n \times l}{n \times l} \left[\begin{array}{l} (e) \\ (e) \end{array} \right]$ <p>see 16.4.2.4</p>
6	Plug or slot weld		$\left. \begin{array}{l} l \\ (e) \\ n \end{array} \right\} \text{ (see No. 4)}$ <p>c : width of slot</p> $c \sqcap n \times l (e)$ <p>see 16.4.2.5</p>
7	Seam weld		$\left. \begin{array}{l} l \\ (e) \\ n \end{array} \right\} \text{ (see No. 4)}$ <p>c : width of weld</p> $c \oplus n \times l (e)$
			<p>n : (see No. 4)</p> <p>d : diameter of hole</p>
9	Spot weld		<p>n : (see No. 4)</p> <p>(e) : spacing</p> <p>d : diameter of spot</p> $d \bigcirc n \times (e)$

81

SECTION 17 DRAWING PRACTICE FOR ISOMETRIC PROJECTION

17. Scope – This section lays down the principles of isometric projection.

17.1 The isometric projection is used in the preparation of such drawings in which the essential features are required to be shown otherwise in three views.

17.2 Drafting Aids

17.2.1 Drafting aids for drawing in isometric

drafting machines, isometric grid (see Fig. 17.4).

17.2.2 For the preparation of drawings in pipe-work construction it is also customary to use computer-controlled curve plotters. When a drafting machine is used without a grid, it is advisable to work with the following detent settings:

- A Vertical
- B at angle α (-30° to the horizontal)
- C at angle β ($+30^\circ$ to the horizontal)

The lines in the isometric grid are arranged as indicated under A, B and C.

NOTE – When it is used for pipework and fittings

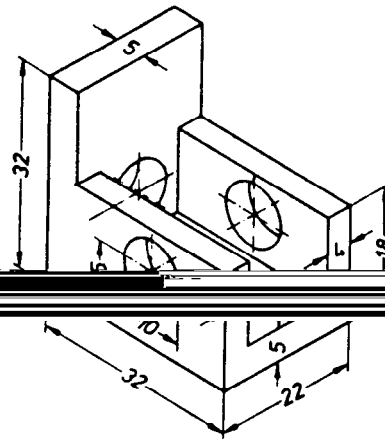


FIG. 17.2

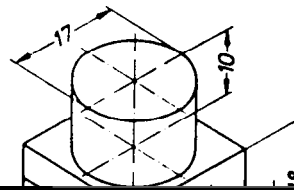


FIG. 17.3

17.3 Representation Without a Grid – The representation of a cube and of circles in three views is shown in Fig. 17.1. Dimensioning examples are shown in Fig. 17.2 and 17.3

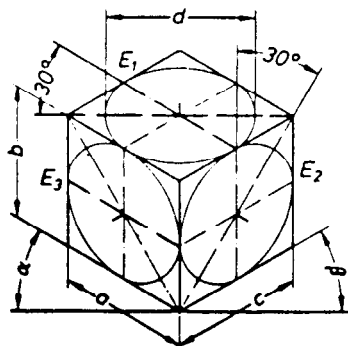


FIG. 17.1

Ratio of sides $a : b : c = 1 : 1 : 1$

$\alpha = 30^\circ$

$\beta = 30^\circ$

Ratio of edges : diameter $d = 1 : 0.82$

Ellipse E_1 ... major axis horizontal

Ellipse E_2 ... major axis at right angles to 30°

Ellipse E_3 ... major axis at right angles to 30°

Ratio of the axes with all ellipses = $1 : 1.7$

17.4 Representation Using a Grid – Figure 17.4 shows the representation of a component on an isometric grid.

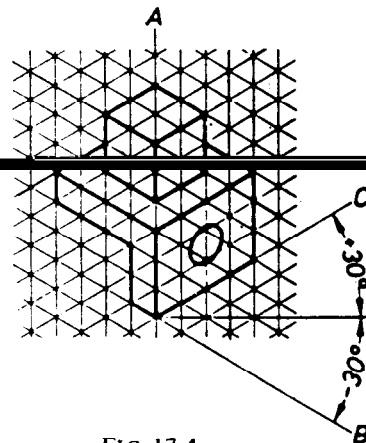


FIG. 17.4

17.5 Co-ordinates

17.5.1 For the purpose of standardizing calculations and manufacturing processes, it is desirable to define the principal directions of the co-ordinates.

17.5.2 The positive direction of the Z-axis is the direction in which a right hand thread screw would move if turned by its positive X-axis towards the positive Y-axis.

17.5.3 All co-ordinate values taken from the origin in the direction of the arrow are positive and those in the opposite direction are negative (see Fig. 17.5).

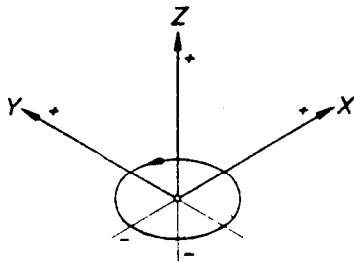


FIG.17.5

17.5.4 The directions of the co-ordinates X, Y, Z are called the principal directions and the areas enclosed by them are called the principal planes.

17.6 Representation in the System of Co-ordinates – In order to provide an unambiguous representation of lines (for example, pipe bends) in isometric projection, it is necessary to show the principal planes by hatching. The planes of the side view (co-ordinates Y, Z) and front view (co-ordinates X, Z) should be hatched vertically and the planes of the top view (co-ordinates X, Y) should be hatched at -30° (See Fig. 17.6).

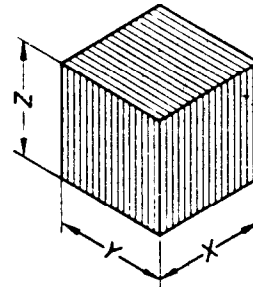


FIG.17.6

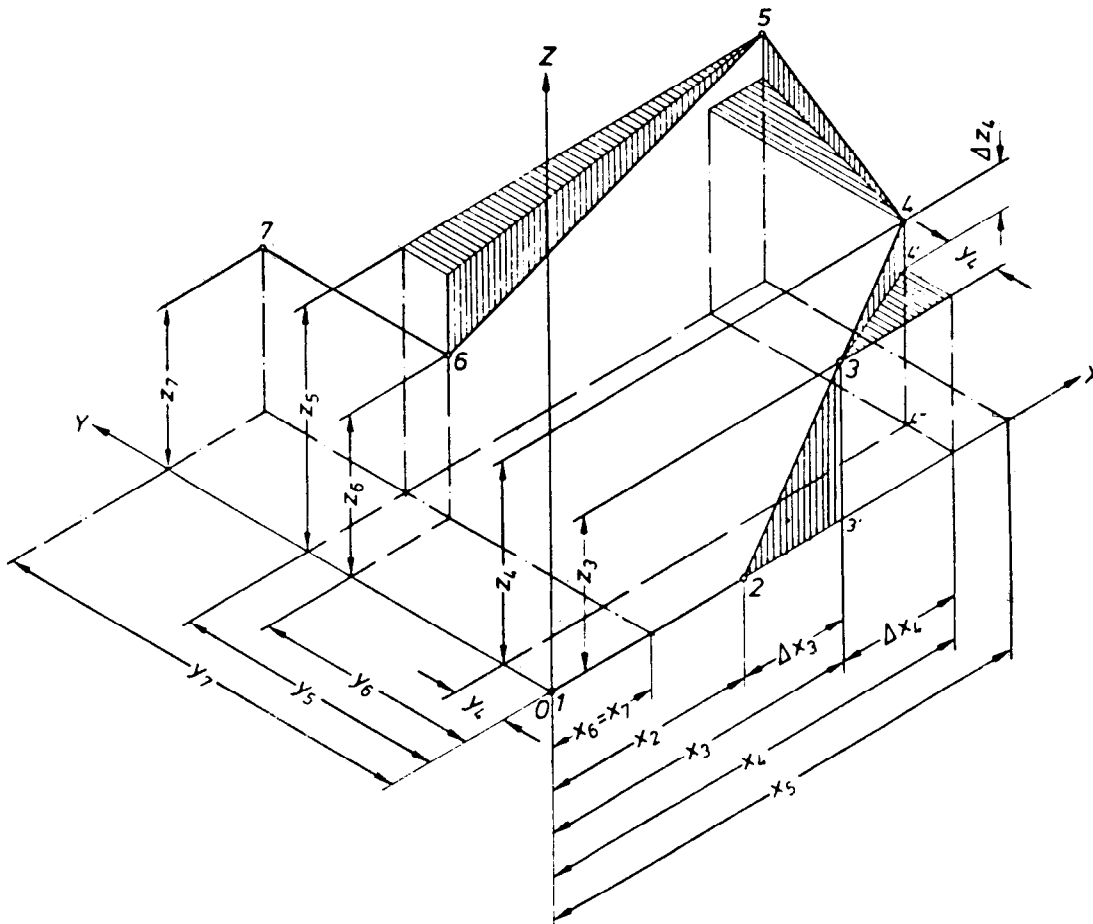


FIG.17.7

Figure 17.7 shows a bent pipe in isometric projection in the co-ordinate system.

TABLE 17.1 CO-ORDINATE VALUES FOR BENT PIPE RUN

Dimensioning is point $L1 (P1)$ with co-ordinates $x_1 = 0, y_1 = 0, z_1 = 0$.

17.6.2 The section 1-2 lies on the X co-ordinate and has co-ordinates $x_2 = +50, y_2 = 0$ and $z_2 = 0$.

17.6.3 Section 2-3 lies in the principal plane X, Z and has dimension x_3 and z_3 and co-ordinates $x_3 = +75, y_3 = 0$ and $z_3 = +34$. The vertical hatching (see Fig. 17.6) shows clearly that the plane of bending of the pipe lies in the principal plane X, Z.

17.6.4 Although in the representation, section 3-4 is a continuation of 2-3, point 4 is outside the principal plane X, Z, and has dimensions x_4, y_4 and z_4 ; their co-ordinates are $x_4 = +104, y_4 = +12$ and $z_4 = +45$. To show the three-dimensional bending clearly in the representation it is necessary to project the co-ordinate point 4 together with point 3 onto the corresponding principal planes and to use hatching as shown in Fig. 17.6. Sections 4-5 and 5-6 are represented in a similar manner whilst Section 6-7 lies in the direction of the Y co-ordinate.

17.7 Dimensioning in the Co-ordinate System – Co-ordinate dimensioning is useful for mechanical calculation of developed lengths, for bending and twisting angles using data processing and for programme-controlled machine tools. The co-ordinates can have positive and negative values (in accordance with Fig. 17.5).

17.7.1 The co-ordinate values for the bent pipe run shown in Fig. 17.7 are given in Table 17.1.

17.8 Representation of Auxiliary Views – Auxiliary views are necessary when edges of solids or surfaces

P	x	y	z
P_1	$x_1 = 0$	$y_1 = 0$	$z_1 = 0$
P_2	$x_2 = +50$	$y_2 = 0$	$z_2 = 0$
P_3	$x_3 = +75$	$y_3 = 0$	$z_3 = +34$
P_4	$x_4 = +104$	$y_4 = +12$	$z_4 = +45$
P_5	$x_5 = +118$	$y_5 = +62$	$z_5 = +54$
P_6	$x_6 = +26$	$y_6 = +52$	$z_6 = +36$
P_7	$x_7 = +26$	$y_7 = +100$	$z_7 = +36$

lie in the viewing direction of the isometric projection. It is advisable to represent the auxiliary view in orthographic projection (see Fig. 17.8).

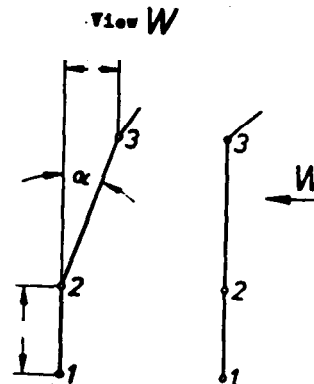


FIG. 17.8 AUXILIARY VIEW IN ORTHOGRAPHIC PROJECTION

17.9 Example of Drawing – Figure 17.9 shows a drawing of a bent pipe in isometric projection with co-ordinate values.

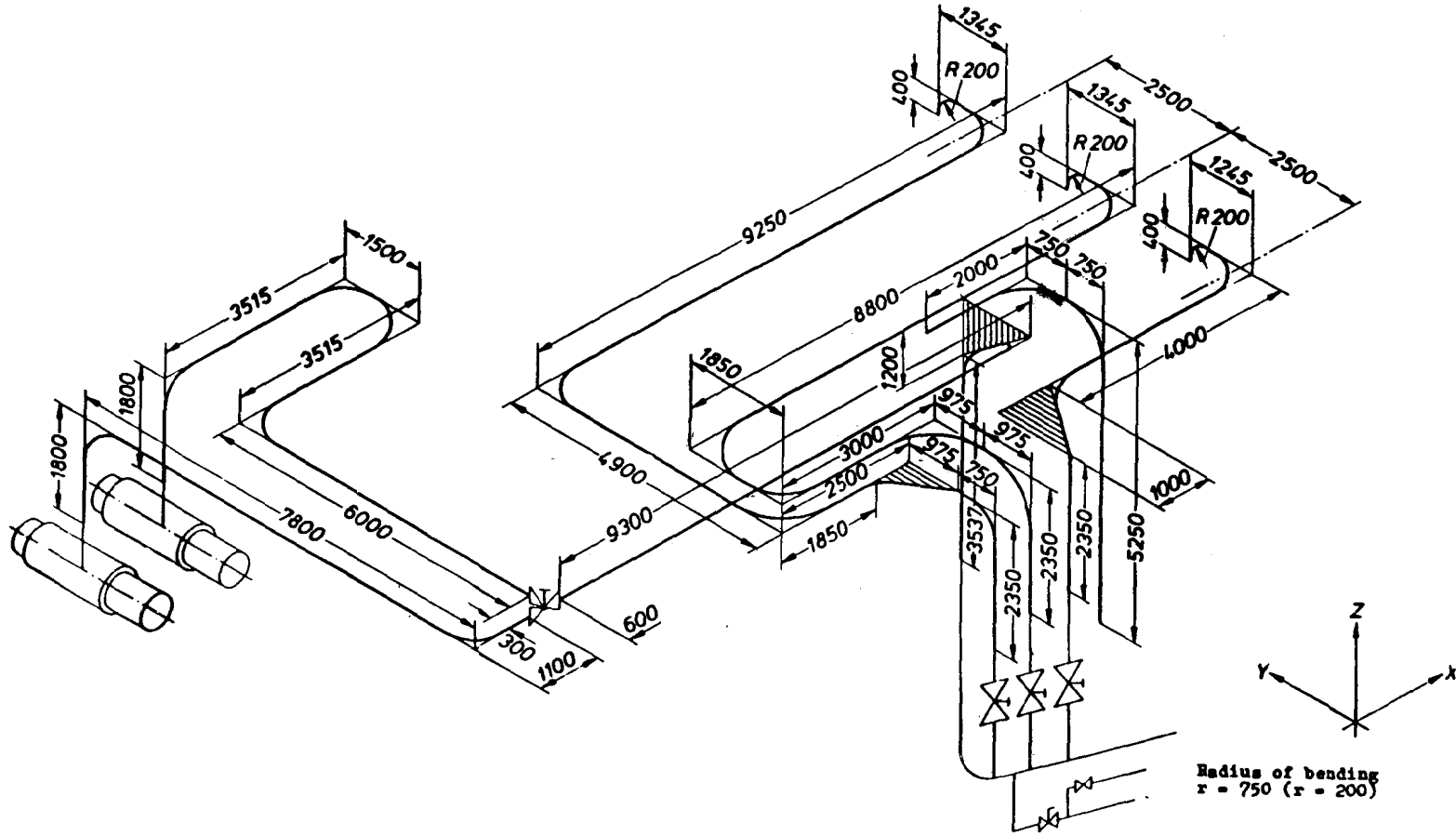


FIG. 17.9 PIPE LAYOUT SHOWN IN ISOMETRIC PROJECTION (EXAMPLE)

SECTION 18 EXAMPLES OF INDICATION AND INTERPRETATION OF GEOMETRICAL TOLERANCING SYMBOLS AND CHARACTERISTICS

18.1 Scope – This section incorporates the examples of indication and interpretation of geometrical tolerancing symbols and characteristics.

18.2 Form tolerances limit the deviations of an individual feature from its ideal geometrical form.

18.3 Orientation, location and run-out tolerances limit the deviations of the mutual orientation and/or location of two or more features. For functional reasons one or more features may be indicated as a datum. If necessary, a geometrical tolerance should be specified to the datum feature in order to ensure that the datum feature is sufficiently exact for its purpose.

18.4 The geometrical tolerance applies always to the

whole extent of toleranced feature unless otherwise specified, for example, 0.02/50 indicates that a tolerance of 0.02 is permitted for an extent of 50 at any place on the toleranced feature.

18.5 When a geometrical tolerance applies to an axis or a median plane, then the arrow of the leader line terminates at the dimension line (see Fig. 18.4).

18.6 When a geometrical tolerance applies to a line or surface itself, then the leader line with its arrow terminating on the contour of the the feature has to be clearly separated from the dimension line (see Fig. 18.5).

18.7 The same method of indication is used for the datum triangle.

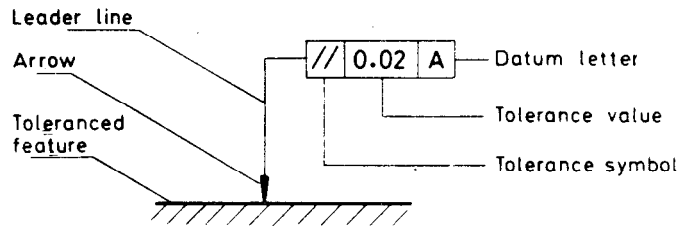


FIG.18.1

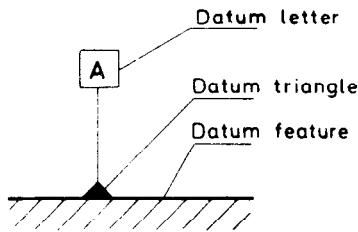


FIG.18.2

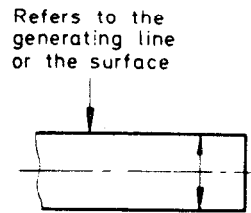


FIG.18.5



FIG.18.3



FIG.18.6

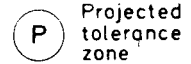


FIG 18.7

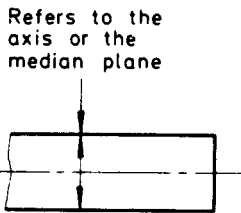


FIG.18.4

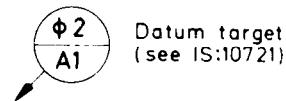


FIG.18.8

TABLE 18.1

Values in millimetres

Symbols and Toleranced Characteristics		Examples of Indication and Interpretation				
		Indication on the drawing	Tolerance zone	Interpretation		
Single features	Form tolerances	— Straightness			The axis of the cylinder, to which the tolerance frame is connected, shall be contained in a cylindrical zone of diameter 0,08.	
		□ Flatness			The surface shall be contained between two parallel planes 0,08 apart.	
		○ Circularity			The circumference of each cross-section shall be contained between two co-planar concentric circles 0,1 apart.	
		⊘ Cylindricity			The considered surface shall be contained between two coaxial cylinders 0,1 apart.	
Single or related features		⌒ Profile of any line			In each section parallel to the plane of projection, the considered profile shall be contained between two lines enveloping circles of diameter 0,04, the centres of which are situated on a line having the true geometrical profile.	
		⌒ Profile of any surface			The considered surface shall be contained between two surfaces enveloping spheres of diameter 0,02, the centres of which are situated on a surface having the true geometrical form.	
Related features	Orientation tolerances	// Parallelism of a line (axis) with reference to a datum line			The toleranced axis shall be contained in a cylindrical zone of diameter 0,03, parallel to the datum axis A (datum line).	
		⊥ Perpendicularity of a line (axis) with reference to a datum surface			The axis of the cylinder, to which the tolerance frame is connected, shall be contained between two parallel planes 0,1 apart, perpendicular to the datum surface.	
		∠ Angularity of a line (axis) with reference to a datum surface			The axis of the hole shall be contained between two parallel planes 0,08 apart which are inclined at 60° to the surface A (datum surface).	
	Location tolerances	⊕ Position of a line			The axis of the hole shall be contained within a cylindrical zone of diameter 0,08, the axis of which is in the theoretically exact position of the considered line, with reference to the surfaces A and B (datum planes).	
		◎ Coaxiality of an axis			The axis of the cylinder, to which the tolerance frame is connected, shall be contained in a cylindrical zone of diameter 0,08 coaxial with the datum axis A-B.	
		≡ Symmetry of a median plane			The median plane of the slot shall be contained between two parallel planes which are 0,08 apart and symmetrically disposed about the median plane with respect to the datum feature A.	
	Run-out tolerances		↻ Circular run-out radial			The radial run-out shall not be greater than 0,1 in any plane of measurement during one revolution about the datum axis A-B.
			↻ Total run-out radial			The total radial run-out shall not be greater than 0,1 at any point on the specified surface during several revolutions about the datum axis A-B, and with relative axial movement between part and measuring instrument. The movement shall be guided along a line having a theoretically perfect form of the contour and being in correct position to the datum axis.

SECTION 19 ABBREVIATIONS

19.1 Scope – This section covers such of the abbreviations which are recommended for use in general engineering drawings. Abbreviations already covered in specific subjects, such as units and quantities, tolerancing, gears, fluid power, electrical and electronics are not dealt in this section.

19.2 Table 19.1 lists some of the common abbreviations recommended. Abbreviations are the same both for singular and plural usage. Only capital letters are used for abbreviations to ensure maintenance of legibility bearing in mind reproduction and reduction processes. Abbreviations which have already been standardized nationally/internationally using lower case letters should, however, be written according to the corresponding standard.

19.2.1 When using abbreviations and symbols in engineering drawings, the following points are to be borne in mind.

- a) They should be used sparingly only when space saving in a drawing is essential.
- b) Short words such as 'day', 'unit', 'time', etc, should preferably be written in full, even when an abbreviation has been standardized.
- c) Periods (full stop symbol) are not to be used except where the abbreviation marks a word (for example, No.; FIG.)
- d) For hyphenated words, abbreviations are to be with the hyphen.
- e) Sometimes one and the same letter symbol may represent more than one term or quantity. Hence it is advisable not to use such symbols which mean two different terms in one and the same drawing. If it becomes unavoidable, the symbols may be provided with suitable subscript.

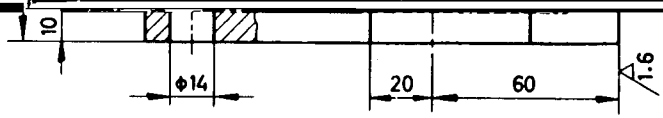
TABLE 19.1 RECOMMENDED ABBREVIATIONS

<i>Term</i>	<i>Abbreviation</i>	<i>Term</i>	<i>Abbreviation</i>
Across corners	A/C	Ground level	GL
Across flats	A/F	Hexagon/Hexagonal	HEX
Alteration	ALT	Horizontal	HORZ
Approved	APPD	Hydraulic	HYD
Approximate	APPROX	Head	HD
Arrangement	ARRGT	Indian Standard	IS
Assembly	ASSY	Inspection/ed	INSP
Auxiliary	AUX	Inside diameter	ID
Bearing	BRG	Insulation	INSUL
Cast iron	CI	Internal	INT
Centres	CRS	Left hand	LH
Centre line	CL	Long	LG
Centre of gravity	CG	Machine/machinery	M/C
Centre-to-centre	C/C	Manufacture/ing	MFG
Chamfered	CHMED	Material	MATL
Checked	CHKD	Maximum	max.
Cheese head	CH HD	Mechanical	MECH
Continued	CONTD	Minimum	min.
Constant	CONST	Miscellaneous	MISC
Counterbore	C'BORE	Modification	MOD
Countersunk	CSK	Nominal	NOM
Countersunk head	CSK HD	North	N
Cylinder/cylindrical	CYL	Number	NO.
Diameter (in a note)	DIA	Opposite	OPP
Dimension	DIM	Outside diameter	OD
Drawing	DRG	Pitch circle diameter	PCD
East	E	Quantity	QTY
etcetera	etc	Radius (in a note)	RAD
External	EXT	Reference	REF
Figure	FIG.	Required	REQD
General	GEN	Right hand	RH

TABLE 19.1 (Concluded)

<i>Term</i>	<i>Abbreviation</i>	<i>Term</i>	<i>Abbreviation</i>
Round	RD	Thick	THK
Screw/Screwed	SCR	Thread (in a note)	THD
Serial number	SL NO.	Through (in a note)	THRU
Sheet	SH	Tolerance	TOL
Sketch	SK	Typical	TYP
South	S	Undercut (in a note)	U/C
Specification	SPEC	Weight	WT
Spotface	SF	West	W
Standard	STD	With reference to/	
Symmetrical (in a note)	SYM	With respect to (in a note)	WRT
Temperature (in a note)	TEMP		

As in the Original Standard, this Page is Intentionally Left Blank

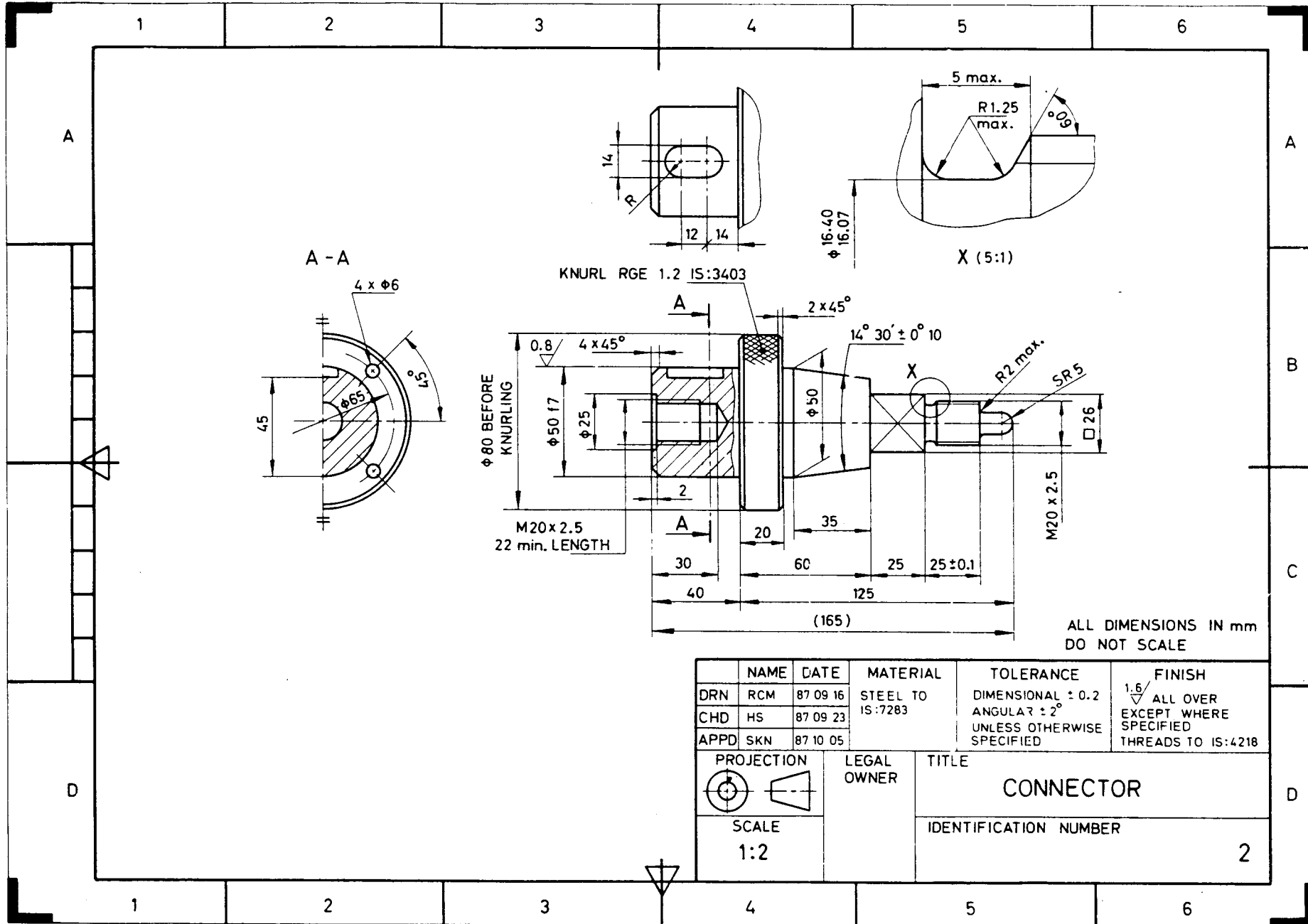


ALL DIMENSIONS IN mm
DO NOT SCALE

DRN	NAME	DATE	MATERIAL	TOLERANCE	FINISH
RCM		87 08 21	MALLEABLE CAST IRON TO IS:2107	CAST DIM ± 1.5	AS CAST EXCEPT WHERE SPECIFIED
HS		87 08 25		MACHINED DIM ± 0.2	THREADS TO IS:4218
SKN		87 08 31		ANGULAR DIM $\pm 0^\circ 30'$	
PROJECTION			LEGAL OWNER	TITLE	
				SWIVEL BRACKET	
SCALE				IDENTIFICATION NUMBER	
1:2				1	

1 2 3 4

TYPICAL EXAMPLES



NAME	DATE	MATERIAL	TOLERANCE	FINISH
DRN RCM	87 09 16	STEEL TO IS:7283	DIMENSIONAL ± 0.2	1.6/√ ALL OVER EXCEPT WHERE SPECIFIED THREADS TO IS:4218
CHD HS	87 09 23		ANGULAR ± 2° UNLESS OTHERWISE SPECIFIED	
APPD SKN	87 10 05			
PROJECTION	LEGAL OWNER	TITLE	CONNECTOR	
SCALE 1:2		IDENTIFICATION NUMBER		
			2	

APPENDIX B SYSTEMS OF LIMITS AND FITS

B-1. General – For the sake of simplicity, and in view of the particular importance of cylindrical parts with circular parts with circular section, only limits and fits are referred to explicitly. It should be clearly understood however that recommendations for this type of component apply equally well to other plain parts or components; in particular, the general term ‘hole’ or ‘shaft’ can be taken as referring to the space containing or contained by two parallel faces (or tangent planes) of any part, such as the width of a slot, the thickness of the key, etc.

B-2. Reference Temperature – The standard reference temperature is 20°C for industrial measurements and, consequently, for dimensions defined by the system (see B-5).

B-3. Tolerances of Parts – Due mainly to the inevitable inaccuracy of manufacturing methods, a part cannot be made precisely to a given dimensions but, in order to meet its purpose, it is sufficient that it should be made so as to lie within two permissible limits of size, the difference of which is the tolerance.

B-3.1 For the sake of convenience, a basic size is ascribed to the part and each of the two limits is defined by its deviation from basic size. The magnitude and sign of the deviation are obtained by subtracting the basic size from the limit in question.

B-3.2 Figure B-1 which illustrates these definitions, is in practice replaced by a schematic diagram similar

to Fig. B-2 for the sake of simplicity. In this simplified schematic diagram, the axis of the part, which is not represented, always lies, by convention, below the diagram. (in the example illustrated, the two deviations of the shaft are negative and those of the hole positive).

B-4. Fits – When two parts are to be assembled, the relation resulting from the difference between their sizes before assembly is called a fit.

B-4.1 Depending upon the respective positions of the tolerance zones of the hole or the shaft, the fit may be a clearance fit, a transition fit (that is such that the assembly may have either a clearance or an interference), or an interference fit.

B-4.2 Figure B-1 shows a clearance fit, and Fig. B-3 shows the schematic diagram of tolerance zone in various cases.

B-5. Fit System – Two of the most commonly used methods of applying are the hole-basis system and the shaft-basis system which are shown in Fig. B-4.

B-6. Symbols for Tolerances and Deviations and Symbols for Fits – In order to satisfy the usual requirements both of individual parts and of fits, the System provides, for any given basic size, a whole range of tolerances together with a whole range of deviations defining the position of these tolerances with respect to the line of zero deviation, called the

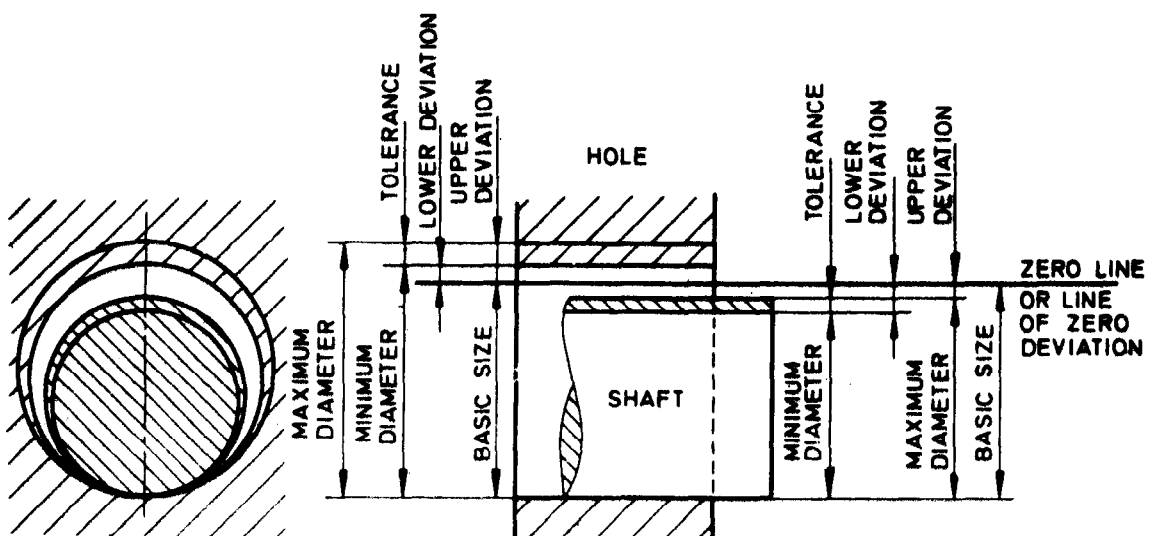
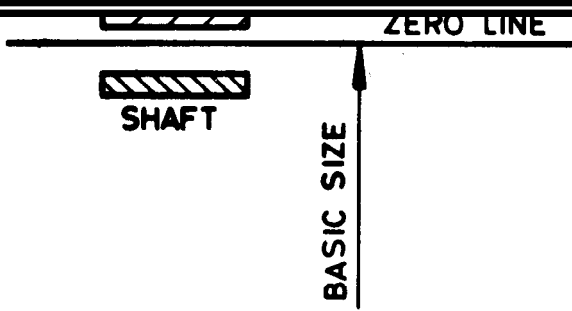


FIG. B-1 DIAGRAM ILLUSTRATING BASIC SIZE DEVIATIONS AND TOLERANCES



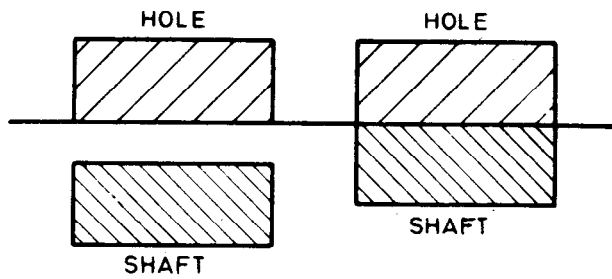
symbol, called the grade.

B-6.2 The position of the tolerance zone with respect to the zero line, which is a function of the basic size, is indicated by a letter symbol (in some cases, two letters), a capital letter for holes, a small letter for shafts (see Fig. B-5).

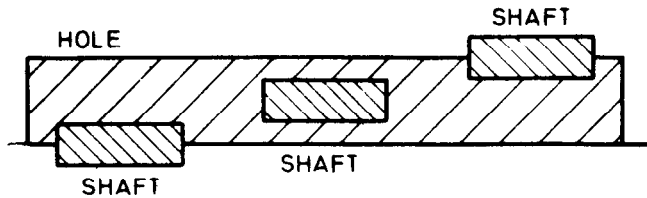
B-6.3 The toleranced size is thus defined by its basic value followed by a 'symbol' composed of the letter (in some cases, two letters) and a number.

Examples: 45 g7.

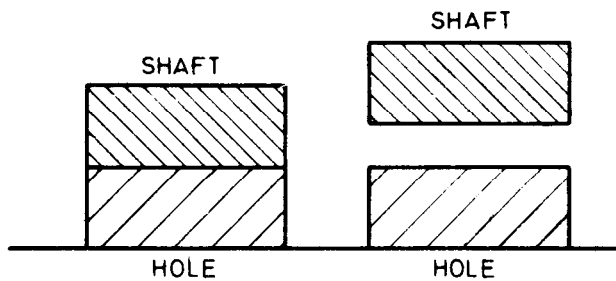
FIG. B-2 SIMPLIFIED SCHEMATIC DIAGRAM OF CLEARANCE FIT



Schematic Representation of Clearance Fit



Schematic Representation of Transition Fit



Schematic Representation of Interference Fit

FIG. B-3

B-6.4 A fit is indicated by the basic size common to both components, followed by symbol corresponding to each component, the hole being quoted first.

Example: 45 H8/g7 (possibly 45 H8-g7 or 45 H8/g7).

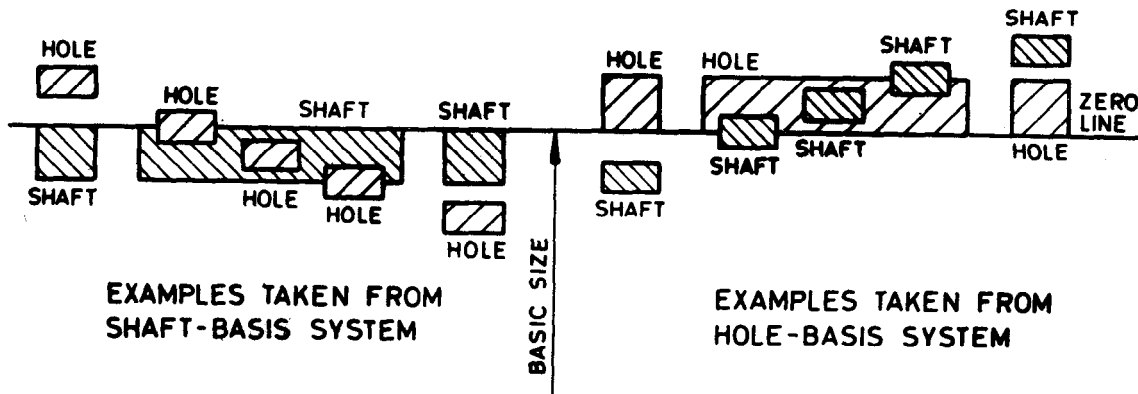


FIG. B-4 EXAMPLES ILLUSTRATING THE SHAFT BASIS AND HOLE BASIS SYSTEM

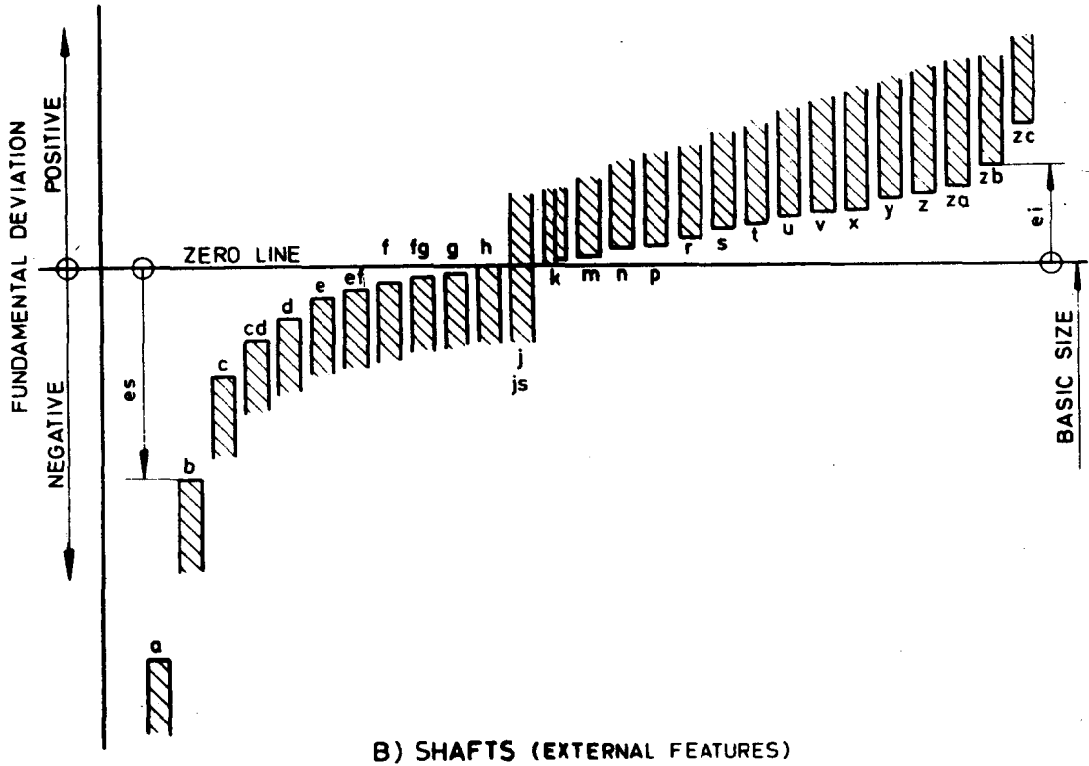
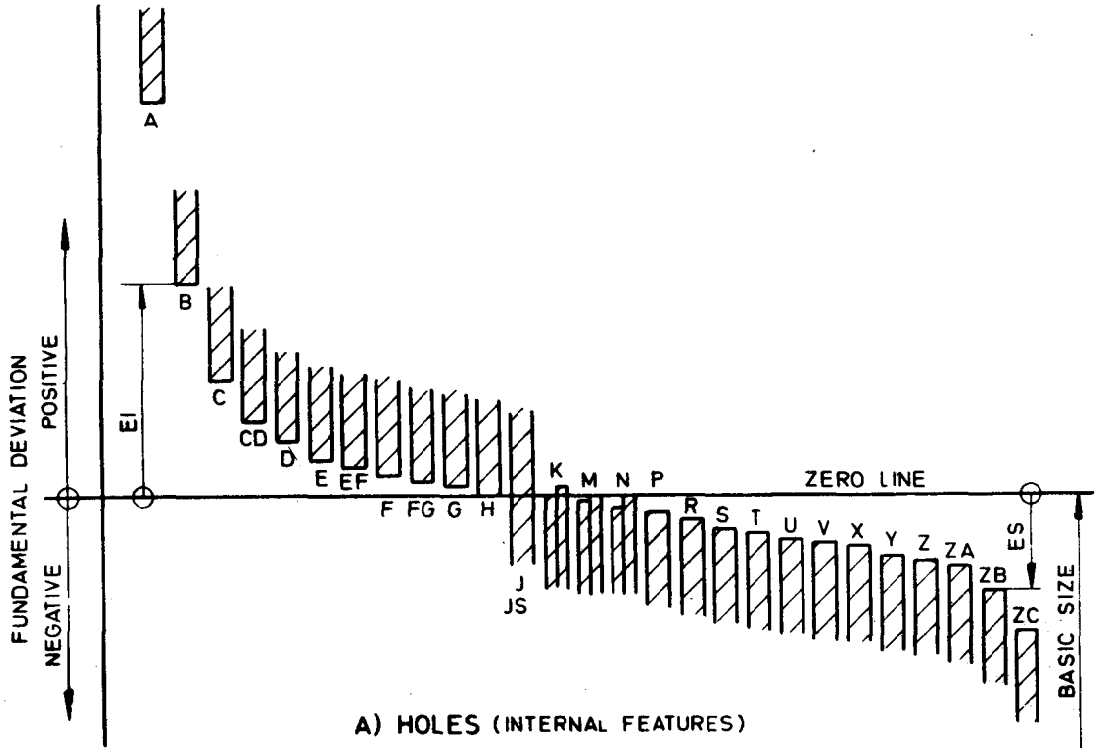


FIG. B-5

APPENDIX C

GUIDE FOR SELECTION OF FITS

C-1. General This guide gives recommendations for the selection of fits in engineering problems concerned with the mating of a shaft and a hole. These recommendations are also applicable to non-cylindrical fits.

C-1.1 This guide gives the representative usage of various classes and grades of fit. These examples are only of an illustrative character and they do not specify any design details.

C-2. Systems of Fits

C-2.1 The hole basis system is the system of fits in which design size of the hole is the basic size and the allowance is applied to the shaft (see Fig C-1). In the shaft basis system the design size of the shaft is the basic size and the allowance is applied to the hole.

product, the manufacturing methods, the condition of the raw material, etc.

C-2.1.2 The hole basis system is the extensively used system. This is because a hole is more difficult to produce than a shaft due to the fixed character of

hole producing tools. The shaft basis system should only be used where it will convey unquestionable economic advantages, that is where it is necessary to be able to mount several parts with holes having different deviations on a single shaft of drawn steel bar without machining the latter.

C-2.1.3 The designers should decide on the adoption of either system to secure general interchangeability. A shaft dimension to a certain class of fit with a hole in the hole basis system differs from the shaft giving the same fit in the shaft basis system.

C-3. Classification of Fits

C-3.1 The system of fits may be broadly classified as clearance fit, transition fit and interference fit.

C-3.1.1 Clearance fit results in a positive clearance over the whole range of the tolerance

hole H.

C-3.1.2 Transition fit may result in either a clearance fit or interference fit depending on the actual value of the individual tolerances of the mating components. Shafts js to n produce transition fit with the basic hole H.

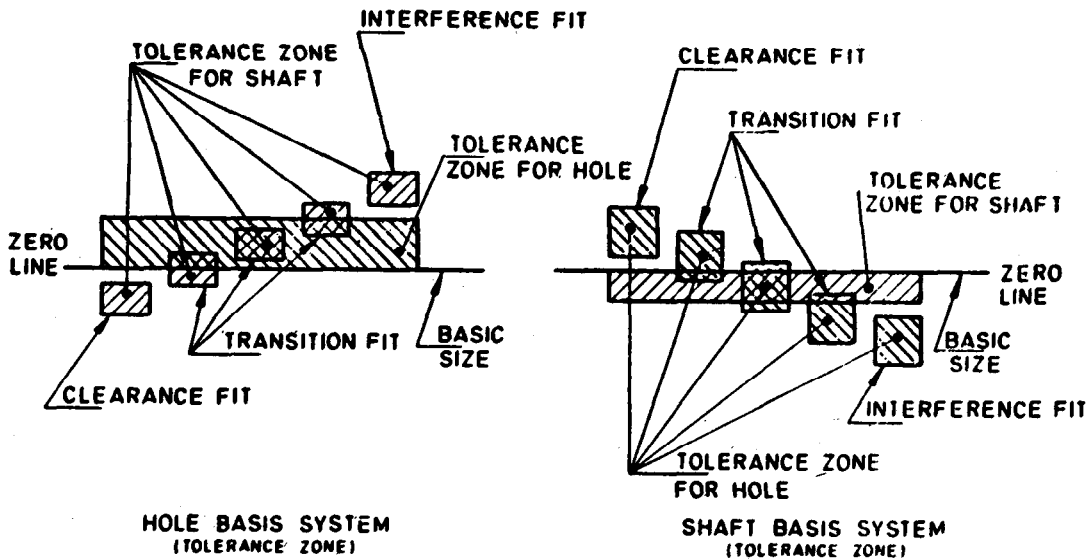


FIG. C-1 EXAMPLE ILLUSTRATING HOLE BASIS AND SHAFT BASIS SYSTEMS

Nominal Size Rang	Over up to 80	+93 +71	+73 +51	+59	+45	+25	+11	0	0	0	0	-12	-36	-72	-120	-170 -390	-220 -440	-380 -600	-58 -93	-38 -73	-24	-10	+10	+17.5	+35	+54	+87	+220	+47	+90	+159	+260	+390 +170	+440 +220	+600 +380	
	Over up to 100	+101 +79	+76 +54	+37	+23	+3	-11	-22	-35	-87	-220	-34	-71	-126	-207	-180 -400	-240 -460	-410 -630	-66 -101	-41 -76	-59	-45	-25	-17.5	0	0	0	0	+12	+36	+72	+120	+400 +180	+460 +240	+630 +410	
	Over up to 120	+117 +92	+88 +63													-200 -450	-260 -510	-460 -710	-77 -117	-48 -88												+450 +200	+510 +260	+710 +460		
	Over up to 140	+125 +100	+90 +65	+68 +43	+52 +27	+28 +3	+12.5 -12.5	0 -25	0 -40	0 -100	0 -250	0	-14 -39	-43 -83	-85 -148	-145 -245	-210 -460	-280 -530	-520 -770	-85 -125	-50 -90	-28 -68	-12 -52	+12 -28	+20 -20	+40 0	+63 0	+100 0	+250 0	+54 +14	+106 +43	+185 +85	+305 +145	+460 +210	+530 +280	+770 +520
	Over up to 160	+133 +108	+93 +68													-230 -480	-310 -560	-580 -830	-93 -133	-53 -93													+480 +230	+560 +310	+830 +580	
	Over up to 180	+151 +122	+106 +77													-240 -530	-340 -630	-660 -950	-105 -151	-60 -106														+530 +240	+630 +340	+950 +660
	Over up to 200	+159 +130	+109 +80	+79 +50	+60 +31	+33 +4	+14.5 -14.5	0 -29	0 -46	0 -115	0 -290	0	-15 -44	-50 -96	-100 -172	-170 -285	-260 -550	-380 -670	-740 -1 030	-113 -159	-63 -109	-33 -79	-14 -60	+13 -33	+23 -23	+46 0	+72 0	+115 0	+290 0	+61 +15	+122 +50	+215 +100	+355 +170	+550 +260	+670 +380	+1 030 +740
	Over up to 225	+169 +140	+113 +84													-280 -570	-420 -710	-820 -1 110	-123 -189	-67 -113														+570 +283	+710 +420	+1 110 +820
	Over up to 250	+190 +158	+126 +94	+88	+66	+36	+16	0	0	0	0	0	-17	-56	-110	-190	-300 -620	480 800	-920 -1 240	-138 -190	-74 -126	-36	-14	+16	+26	+52	+81	+130	+320	+69	+137	+240	+400	+620 +300	+800 +480	+1 240 +920
	Over up to 280	+202 +170	+130 +98	+56	+34	+4	-16	-32	-52	-130	-320	-49	-108	-191	-320	-330 -650	540 860	-1 050 -1 370	-150 -202	-78 -130	-88	-66	-36	-26	0	0	0	0	0	+17	+58	+110	+190	+650 +330	+860 +540	+1 370 +1 050
	Over up to 315	+226 +190	+144 +108	+98	+73	+40	+18	0	0	0	0	-18	-62	-125	-210	-360 -720	600 960	-1 200 -1 560	-169 -226	-87 -144	-41	-16	+17	+28.5	+57	+89	+140	+360	+75	+151	+265	+440	+720 +360	+960 +600	+1 560 +1 200	
	Over up to 355	+244 +208	+150 +114	+62	+37	+4	-18	-35	-57	-140	-360	-54	-119	-214	-350	-400 -760	680 1 040	-1 350 -1 710	-187 -244	-93 -150	-98	-73	-40	-28.5	0	0	0	0	+18	+69	+125	+210	+760 +400	+1 040 +610	+1 710 +1 350	
	Over up to 400	+272 +232	+166 +126	+108	+80	+45	+20	0	0	0	0	-20	-68	-135	-230	-440 -840	760 1 160	-1 500 -1 900	-209 -272	-103 -166	-45	-17	+18	+31.5	+63	+97	+155	+400	+83	+165	+290	+480	+840 +440	+1 160 +760	+1 900 +1 500	
	Over up to 450	+292 +252	+172 +132	+68	+40	+5	-20	-40	-63	-155	-400	-60	-131	-232	-385	-480 -880	840 1 240	-1 650 -2 050	-229 -292	-109 -172	-108	-80	-45	-31.5	0	0	0	0	+20	+68	+135	+230	+880 +480	+1 240 +840	+2 050 +1 650	

TABLE C-3 RECOMMENDED FITS (CLEARANCE AND INTERFERENCE FITS)—DIMENSIONS IN μm

Nominal Size Range, mm		H7	S7	H7	R7	H7	P7	H7	N7	H7	K7	Js7	H7	H8	H8	H11	H11	H7	G7H7	H7	F8	H8	F8	H8	E8	H8	H9	D10	H11	D10	C11	CW H11	B11	H11	A11H11	
		s6	h6	r6	h6	p6	h6	n6	h6	h6	h6	h6	h6	h7	h9	h9	h11	h11	js6	h8g8	f7	h6	f7	h9	e8	h9	d9	d9	h9	h11	h11	h9	h11	h11	h11	h11
From up to	1 3	-4 -20	-8 -24	0 -16	-4 -20	+4 -12	0 -16	+6 -10	+2 -14	+10 -6	+6 -10	+11 -5	+16 0	+24 0	+39 0	+85 0	+129 0	+13 +3	+18 +2	+26 +6	+26 +6	+30 +6	+45 +6	+42 +14	+64 +14	+59 +20	+70 +20	+85 +20	+105 +20	+120 +20	+145 +60	+130 +60	+206 +140	+260 +140	+390 +270	
Over up to	3 6	-7 -27	-7 -27	-3 -23	-3 -23	0 -20	0 -20	+4 -16	+4 -16	+11 -9	+11 -9	+14 -6	+20 0	+30 0	+48 0	+105 0	+150 0	+16 +4	+24 +4	+34 +10	+36 +10	+40 +10	+58 +10	+56 +20	+80 +20	+78 +30	+90 +30	+108 +30	+135 +30	+153 +30	+175 +70	+220 +70	+223 +140	+290 +140	+420 +270	
Over up to	6 10	-8 -32	-8 -32	-4 -28	-4 -28	0 -24	0 -24	+5 -19	+5 -19	+14 -10	+14 -10	+16.5 -7.5	+24 0	+37 0	+58 0	+126 0	+180 0	+19.5 +4.5	+29 +5	+43 +13	+44 +13	+50 +13	+71 +13	+69 +25	+97 +25	+98 +40	+112 +40	+134 +40	+166 +40	+188 +40	+206 +80	+260 +80	+249 +150	+330 +150	+460 +260	
Over up to	10 14	-10	-10	-5	-5	0	0	+6	+6	+17	+17	+20	+29	+45	+70	+153	+220	+23.5	+35	+52	+54	+61	+66	+86	+118	+120	+136	+163	+203	+230	+248	+315	+271	+370	+510	
Over up to	14 18	-39	-39	-34	-34	-29	-29	-23	-23	-12	-12	-9	0	0	0	0	0	+5.5	+6	+16	+16	+16	+16	+32	+32	+50	+50	+50	+50	+50	+50	+95	+95	+150	+150	+290
Over up to	18 24	-14	-14	-7	-7	-1	-1	+6	+6	+19	+19	+23	0	0	0	+182	+260	+27.5	+41	+62	+66	+74	+105	+106	+144	+150	+169	+201	+247	+279	+292	+370	+293	+420	+560	
Over up to	24 30	-48	-48	-41	-41	-35	-35	-28	-28	-15	-15	-10.5	0	0	0	0	0	+6.5	+7	+20	+20	+20	+20	+40	+40	+65	+65	+65	+65	+65	+65	+110	+110	+160	+160	+300
Over up to	30 40	-18	-18	-9	-9	-1	-1	+8	+8	+20	+20	+28.5	+41	+64	+101	+222	+320	+33	+50	+75	+80	+89	+126	+128	+174	+181	+204	+242	+302	+340	+342 +120	+440 +120	+306 +170	+490 +170	+630 +310	
Over up to	40 50	-59	-59	-50	-50	-42	-42	-33	-33	-18	-18	-12.5	0	0	0	0	0	+8	+9	+25	+25	+25	+25	+50	+50	+80	+80	+80	+80	+80	+80	+352 +130	+450 +130	+358 +180	+500 +180	+640 +320
Over up to	50 65	-23 -72	-23 -72	-11 -60	-11 -60	-2	-2	+10	+10	+28	+28	+34	+49	+76	+120	+264	+380	+39.5	+59	+90	+95	+106	+150	+152	+208	+220	+248	+294	+364	+410	+404 +140	+520 +140	+399 +190	+570 +190	+720 +340	
Over up to	65 80	-29 -78	-29 -78	-13 -62	-13 -62	-51	-51	-39	-39	-21	-21	-15	0	0	0	0	0	+9.5	+10	+30	+30	+30	+30	+60	+60	+100	+100	+100	+100	+100	+100	+414 +150	+530 +150	+409 +200	+580 +200	+740 +360
Over up to	80 100	-36 -93	-36 -93	-16 -73	-16 -73	-2	-2	+12	+12	+32	+32	+39.5	+57	+89	+141	+307	+440	+46	+69	+106	+112	+125	+177	+180	+246	+261	+294	+347	+427	+480	+477 +170	+610 +170	+462 +220	+660 +220	+820 +390	
Over up to	100 120	-44 -101	-44 -101	-19 -76	-19 -76	-59	-59	-45	-45	-25	-25	-17.5	0	0	0	0	0	+11	+12	+36	+36	+36	+36	+72	+72	+120	+120	+120	+120	+120	+120	+487 +180	+620 +180	+482 +240	+680 +240	+850 +410
Over up to	120 140	-52 -117	-52 -117	-23 -88	-23 -88																											+550 +200	+700 +200	+535 +260	+760 +260	+900 +460
Over up to	140 160	-60 -125	-60 -125	-25 -90	-25 -90	-3	-3	+13	+13	+37	+37	+45	+65	+103	+163	+350	+500	+52.5 +12.5	+79 +14	+123 +43	+131 +43	+146 +43	+206 +43	+211 +85	+285 +85	+308 +145	+345 +145	+405 +145	+495 +145	+555 +145	+560 +210	+710 +210	+555 +280	+780 +280	+1020 +520	
Over up to	160 180	-68 -133	-68 -133	-28 -93	-28 -93																											+580 +230	+730 +230	+585 +310	+810 +310	+1080 +580
Over up to	180 200	-76 -151	-76 -151	-31 -106	-31 -106																											+645 +240	+820 +240	+659 +340	+920 +340	+1240 +680
Over up to	200 225	-84 +159	-84 -159	-34 -109	-34 -109	-4	-4	+15	+15	+42	+42	+52	+75	+118	+187	+405	+580	+60.5 +14.5	+90 +15	+142 +50	+151 +50	+168 +50	+237 +50	+244 +100	+330 +100	+357 +170	+400 +170	+470 +170	+575 +170	+645 +170	+665 +260	+840 +260	+699 +380	+960 +380	+1320 +740	
Over up to	225 250	-94 -169	-94 -169	-38 -113	-38 -113																											+685 +280	+860 +280	+739 +420	+1300 +420	+1400 +820
Over up to	250 280	-106 -190	-106 -190	-42 -126	-42 -126	-4	-4	+18	+18	+48	+48	+58	+34	+113	+211	+450	+640	+68	+101	+160	+169	+189	+267	+272	+370	+401	+450	+530	+640	+720	+750 +300	+940 +300	+832 +480	+1120 +480	+1580 +920	
Over up to	280 315	-118 -202	-118 -202	-46 -130	-40 -130	-88	-88	-66	-66	-36	-36	-26	0	0	0	0	0	+16	+17	+56	+56	+56	+56	+110	+110	+190	+190	+190	+190	+190	+190	+780 +330	+970 +330	+892 +540	+1180 +540	+1530 +850
Over up to	315 355	-133 -226	-133 -226	-51 -144	-51 -144	-5	-5	+20	+20	+53	+53	+64.5	+93	+146	+229	+500	+720	+75	+111	+176	+187	+208	+291	+303	+405	+439	+490	+580	+710	+800	+860 +350	+1080 +360	+996 +600	+1320 +600	+1920 +1200	
Over up to	355 400	-151 -244	-151 -244	-57 -150	-57 -150	-98	-98	-73	-73	-40	-40	-28.5	0	0	0	0	0	+18	+18	+62	+62	+62	+62	+125	+125	+210	+210	+210	+210	+210	+210	+900 +400	+1120 +400	+1076 +690	+1400 +690	+2070 +1350
Over up to	400 450	-169 -272	-169 -272	-63 -166	-63 -166	-5	-5	+23	+23	+58	+58	+71.5	+103	+160	+252	+555	+800	+83	+123	+194	+205	+228	+320	+329	+445	+482	+540	+635	+785	+880	+995 +440	+1240 +440	+1200 +760	+1580 +760	+2300 +1300	
Over up to	450 500	-189 -292	-189 -292	-69 -172	-69 -172	-108	-108	-80	-80	-45	-45	-31.5	0	0	0	0	0	+20	+20	+68	+68	+68	+68	+135	+135	+230	+230	+230	+230	+230	+230	+1035 +480	+1280 +480	+1280 +840	+1630 +840	+2450 +1650

C-5.2 Limits for the tolerance zones enclosed in the frames in Tables C-1 are given in Table C-2.

C-5.3 Dimensions for the fits chosen from the tolerance zones enclosed in the frames in Table C-1 are given in Table C-3.

TABLE C-4 COMMONLY USED FITS
(Clause C-3.1.4)

I For Holes							Remarks
Type of Fit	Class of Shaft	With Holes					
		H6*	H7	H8	H9	H11	
Clearance	a	-	-	-	-	a11	Large clearance fit and widely used
	b	-	-	-	-	b11	
	c	-	-	-	-	c11	Slack running fit
	d	-	d8*	d8*, d9, d10	d8*, d9, d10	d9	Loose running fit
	e	e7*	e8	e8, e9*			Easy running fit
	f	f6*	f7	f7, f8*			Normal running fit
	g	g5*	g6	-			Close running fit or sliding fit, also spigot and location fit
Transition	h	h5*	h6	h7, h8*, h9		h11	Precision sliding fit. Also fine spigot and location fit.
	js	js5*	js6	js7*			Push fit for very accurate location with easy assembly and disassembly
	k	k5*	k6	k7*			Light keying fit (true transition) for keyed shafts, non-running locked pins, etc.
	m	m5*	m6*	m7*			Medium keying fit
Interference	n	n5*	n6	n7*			Heavy keying fit (for tight assembly mating surfaces)
	p	p5*	p6	p7*			Light press fit with easy dismantling for non-ferrous parts. Standard press fit with easy dismantling for ferrous and non-ferrous parts assembly
	r	r5*	r6	r7*			Medium drive fit with easy dismantling for ferrous parts assembly Light drive fit with easy dismantling for non-ferrous parts assembly
	s	s5*	s6	s7*			Heavy drive fit for ferrous parts permanent or semi-permanent assembly standard press fit for non-ferrous parts
	t	t5*	t6*	t7*			Force fit on ferrous parts for permanent assembly

* Second preference fits.

(Continued)

TABLE C-4 (Concluded)

H For Shafts								
Type of Fit	Class of Holes	With Shafts						Remarks
		<i>h5*</i>	<i>h6</i>	<i>h7</i>	<i>h8*</i>	<i>h9</i>	<i>h11</i>	
e	A						A11	Large clearance fit widely used
	B						B11	
	C						C11	Slack running fit
Clearance	E		E8*		E8*	E9		Easy running fit
	F		F7*		F8	F8*		Normal running fit
	G	G6*	G7					Close running fit or sliding fit, also spigot and location fit
Transition	H	H6*	H7	H8	H8	H8, H9	H11	Precision sliding fit. Also fine spigot and location fit.
	Js	Js6*	Js7	Js8*				Push fit for very accurate location with easy assembly and disassembly
	K	K6*	K7	K8*				Light keying fit (true transition) for keyed shafts, non-running locked pins, etc.
	M N	M6* N6*	M7* N7	M8* N8*				Medium keying fit Heavy keying fit (for tight assembly of mating surfaces)
Interference	P	P6*	P7					Light press fit with easy dismantling for non-ferrous parts. Standard press fit with easy dismantling for ferrous and non-ferrous parts assembly
	R	R6*	R7					Medium drive fit with easy dismantling for ferrous parts assembly Light drive fit with easy dismantling for non-ferrous parts assembly
	S	S6*	S7					Heavy drive fit for ferrous parts permanent or semi-permanent assembly standard press fit for non-ferrous parts
	T	T6*	T7					Force fit on ferrous parts for permanent assembly

* Second preference fits.

**APPENDIX D
GENERAL TOLERANCES FOR LINEAR AND ANGULAR DIMENSIONS**

D-1. General. Specifies the nominal dimensions, tolerances, etc. and is not applicable for production

tolerance indications.

flame cutting, etc.

D-1.1 This standard is applicable for all machining processes with chips like turning, milling, etc, and without chips like drawing, printing, embossing, pipe

D-2. Deviations

D-2.1 Linear Dimensions – Shall be as given in Table D-1.

TABLE D-1 DEVIATIONS FOR LINEAR DIMENSIONS

(All dimensions in millimetres)

Class of Deviation	Range of Nominal Dimensions												
	Above	0.5	3	6	30	120	315	1000	2000	4000	8000	12000	16000
	Up to and including	3	6	30	120	315	1000	2000	4000	8000	12000	16000	20000
Fine		± 0.05	± 0.05	± 0.1	± 0.15	± 0.2	± 0.3	± 0.5	± 0.8	—	—	—	—
Medium		± 0.1	± 0.1	± 0.2	± 0.3	± 0.5	± 0.8	± 1.2	± 2	± 3	± 4	± 5	± 6
Coarse		—	± 0.2	± 0.5	± 0.8	± 1.2	± 2	± 3	± 4	± 5	± 6	± 7	± 8
Extra coarse		—	± 0.5	± 1	± 1.5	± 2	± 3	± 4	± 6	± 8	± 10	± 12	± 12

D-2.2 Radii and Chamfer – Shall be as given in Table D-2.

TABLE D-2 DEVIATIONS FOR RADII AND CHAMFERS

(All dimensions in millimetres)

Class of Deviation	Range of Nominal Dimensions					
	Above	0.5	3	6	30	120
	Up to and including	3	6	30	120	315
Fine and medium		± 0.2	± 0.5	± 1	± 2	± 4
Coarse and extra coarse		± 0.2	± 1	± 2	± 4	± 8

D-2.3 *Angular Dimensions* – Shall be as given in Table D-3.

TABLE D-3 DEVIATIONS FOR ANGULAR DIMENSIONS

(All dimensions in millimetres)

Class of Deviation	Permissible Variations on Length of Shorter Side of Angle							
	Upto 10		Over 10 to 50		Over 50 to 120		Over 120	
	Degree	mm per 100 mm	Degree	mm per 100 mm	Degree	mm per 100 mm	Degree	mm per 100 mm
Fine and medium	$\pm 1^{\circ}$	± 1.8	$\pm 30'$	± 0.9	± 20	± 0.6	$\pm 10'$	± 0.3
Coarse	$\pm 1^{\circ} 30'$	± 2.6	$\pm 50'$	± 1.5	± 25	± 0.7	$\pm 15'$	± 0.4
Extra coarse	$\pm 3^{\circ}$	± 5.1	$\pm 2^{\circ}$	± 3.5	$\pm 1^{\circ}$	± 1.8	$\pm 30'$	± 0.9

D-3. *Indications in Drawings* – In the space provided for the purpose of drawings or otherwise, two methods of indications are suggested:

a) Class of deviation required shall be indicated,

for example, Medium IS:2102, Coarse IS:2102, etc.

b) The values of the permissible variations to be shown in general note for dimensions without tolerance indications.

ALPHABETICAL INDEX

A

Abbreviations 19
 Additional dimension 11.2.2.5(a)
 Adjacent parts 9.3.1
 Altitude, indication of 11.6.2.2
 Angles 11.5.1
 Angle Section, Table 15.5
 Angular dimension, tolerance of, Appendix D
 Angular dimensional values 11.3.4.1

Cones, dimensioning and tolerancing 13
 Conventional representation of
 – common features, Table 10.2
 – gears 10.4
 – axial section 10.4.1.1 (b)
 – chain wheels 10.4.2.6
 – contours and edges 10.4.1.1
 – direction of teeth 10.4.1.4
 – pitch surfaces 10.4.1.2

Arc end 11.3.3.5
 Arcs 11.5.1
 Arrangement of dimensions 11.4
 Arrangement of successive section 9.2.9
 Arrow heads 11.3.3.1(a)
 Assembly drawings (gear pairs) 10.4.2
 Assembled threaded parts 10.2.1.7
 Assembly drawing, planning of 3
 Auxiliary dimension 11.2.1.1 (c)

– gear assembly
 – external 10.4.2.1
 – internal 10.4.2.2
 – bearing, Table 10.2
 – diamond knurling, Table 10.2
 – radial ribs, Table 10.2
 – ratchet and pinion, Table 10.2
 – repetitive features, Table 10.2
 – screw threads
 – assembled threaded parts 10.2.1.7
 – end view 10.2.1.4
 – hidden screw threads 10.2.1.2
 – incomplete threads 10.2.1.6
 – limit of useful length 10.2.1.5
 – section of threaded parts 10.2.1.3
 – splined shafts, Table 10.2
 – sloated heads, Table 10.2
 – splined shaft, Table 10.2
 – straight knurling, Table 10.2
 – springs 10.3
 – compression springs 10.3.1
 – cup springs 10.3.5
 – leaf springs 10.3.4
 – spiral springs 10.3.6
 – tension springs 10.3.2
 – torsion springs 10.3.3

B

Basic size 12.3.1 (a)
 Bearing, conventional representation of, Table 10.2
 Bolts, Table 15.2 and 15.4
 Border 1.6
 Bulb angle section, Table 15.5
 Bulb flat, Table 15.5

C

Centre line, Table 6.1, 6.5(d), 11.3.2.7
 Centring mark 1.7
 Chain dimensioning 11.4.1
 Chain lines, Tables 6.1
 Chain wheels 10.4.2.6
 Chamfers 11.5.4.1, 15.3, D-2.2
 Channel Section, Table 15.5
 Choice of tolerance C-4
 Choice of views 8.2.4
 Chords 11.5.1
 Circular run-out, Table 18.1
 Circular solid section, Table 15.5
 Circular spacing, dimensioning of 11.5.2.4
 Circularity, Table 18.1

Common feature, dimensioning, from 11.4.2
 Contour lines 11.6.4.2
 Coordinates 11.4.3.2
 Countersinks 11.5.4.2
 Cup springs 10.3.5
 Cutting planes 9.2.5
 designation of 9.2.4.3
 position of 9.2.4.3
 section in one plane 9.2.5.1
 section in two intersecting planes 9.2.5.4
 section in two parallel planes 9.2.5.2
 Cylindricity, Table 18.1

D

Classification of fits C-3
 Clearance fit, Fig. B-3, C-3.1.1
 Coaxiality, Table 18.1
 Coinciding lines
 – order of priority 6.5
 Colour, use of 9.3.10
 Combined dimensioning 11.4.4
 Compression springs 10.3.1
 Commonly used fits
 – for holes, Table C-4.I
 – for shafts, Table C-4.II

Dashed line, Table 6.1
 Datum feature, Fig. 18.2
 Datum letter, Fig. 18.1
 Datum target, symbol, Fig. 18.8.
 Datum triangle, Fig. 18.2

Designation of

- bars 15.5
- bolts 15.2.3.3
- holes 15.2.3.4
- plates 15.5
- profile section 15.5
- rivet 15.2.3.3
- sheet 15.5

Deviations

- for angular dimensions, Table D-3
- for chamfers, Table D-2
- indication in drawings D-3
- positive, Fig. B-5
- negative, Fig. B-5
- for radii, Table D-2

Diagrammatic representation 15.7

Diameter 11.3.4.4

Dimension 11.2.1.1

- auxiliary 11.2.1.1(c)
- functional 11.2.1.1(a), 11.2.2.7
- indication 11.4
- of lettering 7.2
- of line 6.3
- lines 11.3.2
- non functional 11.2.1.1(b)
- out of scale 11.3.4.3
- square 11.3.4.4
- superimposed, running 11.3.4.1(b)
- theoretically exact, Fig. 18.3
- unit 11.2.2.4

Dimensional information 11.2.2.1

Dimensional values 11.3.4, 11.4.2.4

- angular 11.3.4.1
- indication of 11.3.4.1(b),
- out of scale 11.3.4.3
- positioning 11.3.4.2

Dimensioning 11

- arc, length of 15.4
- an assembly 11.5.5.3
- basic taper method 13.4.2
- bolts 15.2.3.5
- chain 11.4.1
- chamfers 11.5.4.1, 15.3
- combined 11.4.4
- common feature 11.4.2
- cones 13
- by coordinates 11.4.3
- coordinate system 17.7
- countersinks 11.5.4.2
- elements of 11.3.1
- elements of revolution 11.5.5.5
- general principles 11
- gusset plate 15.6
- hole 15.2.3.5
- indications, other 11.5.5
- indirect functional 11.2.2.7
- limited area 11.5.5.4
- limited length 11.5.5.4
- method of 11.3
- oblique 11.3.4.1(b)
- parallel 11.4.2.3
- radii 11.5.1
- repeated features 11.5.3
- rivets 15.2.3.5

- space, too small 11.3.3.3
- spacings, angular 11.5.2.2
- spacings, circular 11.5.2.4
- special requirement 11.5.5.6
- spherical diameter 11.3.4.4
- spherical radius 11.3.4.4
- tapered features 13.3
- welds 16.4

Diamond knurling, Table 10.2

Drafting aids 17.2

Drawing sheet 1

Drawings, typical examples of, Appendix A

E

Edges of gear 10.4.1.1

Element of dimensioning 11.3.1

End product 11.2.1.3

End view of screw threads 10.2.1.4

Equidistant features 11.5.2

Examples, Appendix A

F

Features 11.2.1.2

First angle projection 8.2.2.1

- symbol, Fig. 8.3

Fits B.4

Fits commonly used

- for holes, Table C.4 I
- for shafts, Table C.4 II

Flatness, Table 18.1

Folding of drawing print 4

- basic principle 4.2
- for binding, Fig. 4.1
- for storing in filing cabinet, Fig. 4.2

Frames 1.6

Functional dimensions 11.2.1.1(a), 11.2.2.7

G

Gear 10.4

- axial section 10.4.1.1(b)
- chain wheels 10.4.2.6
- contours and edges 10.4.1.1
- engagement
 - bevel 10.4.2.4
 - cylindrical worm, in cross section 10.4.2.5
 - external 10.4.2.1
 - internal 10.4.2.2
- pitch surface 10.4.1.2
- root surface 10.4.1.3
- teeth 10.4.1.4
- teeth, direction of 10.4.1.4

Geometrical tolerancing 18

- location tolerance, Table 18.1
- orientation tolerance, Table 18.1
- related features, Table 18.1
- single feature, Table 18.1

Geometrical tolerancing, symbols for

- angularity, Table 18.1
- circular run-out, Table 18.1
- circularity, Table 18.1
- coaxiality, Table 18.1

- cylindricity, Table 18.1
- Flatness, Table 18.1
- parallelism, Table 18.1
- perpendicularity, Table 18.1
- position, Table 18.1
- profile of any line, Table 18.1
- profile of any surface, Table 18.1
- straightness, Table 18.1
- symmetry, Table 18.1
- total run-out, Table 18.1

Grid 17.4
Grid reference, 1.8
Gusset plate, 15.6

- termination of 6.6

Leaf spring 10.3.4
Lettering 7

- dimensions 7.2
- inclined 7.3

Lettering A, Table 7.1

- specimen 7.5.1

Lettering B Table 7.2

- specimen 7.5.2

Levels, indication of 11.6

- on horizontal (plan) views 11.6.3
- on sections 11.6.3
- on vertical section 11.6.2
- on vertical views 11.6.2

Half section 9.2.7
Hatching 9.2.1

- to indicate type of material 9.2.2

Limits and fit, Appendix B
Limits of partial views 8.2.6
Limit of sizes 12.3.3

- in one direction 12.3.4

Hexagonal hollow section, Table 15.5
Hexagonal solid section, Table 15.5
Hidden screw threads, 10.2.1.2
Hidden out lines and edges, 6.5(b)
Holes, Table 15.2 & 15.3
Hole basis system C-2.1.2

- coinciding, order of priority 6.5
- spacing of 6.4
- thickness 6.3
- thickness ratio 6.3.1
- types of 6.2

Linear dimensions

- component of 12.3
- ISO symbols 12.3.1
- tolerances of, Appendix D

Local sections 9.2.8
Local views 8.2.7
Location tolerance, Table 18.1

I

I-beam section, Table 15.5
Incomplete threads, 10.2.1.6
Indication of deviations

- order of 12.4
- Limit of sizes, 12.4

Indication of

- dimensions 11.4
- dimensional Valves, 11.3.4

Indication of tolerances, 12.5
Initial outlines 9.3.9

Interference fit, Fig. B-3, C-3.1.3
Interrupted views 9.3.6

Intersections 9.3.2

- imaginary, 9.3.2.2
- simplified representation, 9.3.2.3
- true 9.3.2.1

Isometric projection, 17

- auxiliary view, 17.8
- coordinates 17.5
- examples Fig. 17.9
- representation
- coordinate system 17.6
- with grid 17.4
- without grid 17.3

Item list 2.4
Item reference 2.2

- Presentation 2.3

K

Knurling

- diamond, Table 10.2
- straight, Table 10.2

L

Lay out of drawing 1.4
Leader lines 11.3.2, 11.6.3.1

M

Machining allowance 14.3.4
Maximum material condition symbol, Fig. 18.1
Method of indication of projection 8.2.3
Multiple sheet drawings 1.9

N

Negative deviations - Fig. B-5
Non-horizontal dimension lines 11.3.4.1
Non-functional dimension 11.2.1.1

O

Oblique dimension line 11.3.4.1(b)
Oblique stroke 11.3.3.1(b)
Order of priority of coinciding lines 6.5
Orientation tolerances, Table 18.1
Origin indication, termination 11.3.3.
Out line 11.3.2.7
Out of scale - dimension values, 11.3.4.3

P

Parallelism, symbol of, Table 18.1
Parallel dimensioning, 11.4.2.3
Partial section 11.5.5.2
Partial views 8.2.6
Parts located in front of a cutting plane 9.3.4
Permissible deviations 12.3.2
Pitch surface of gear 10.4.1.2
Planning of assembly drawings 3

Plates 15.5.2

Position, symbol, of, Table 18.1

Positioning of dimensional values 11.3.4.2

Positive deviation Fig. B-5

Presentation

– general principle 8

Profile of any line, Table 18.1

Profile of any surface, Table 18.1

Projection

– first angle 8.2.2.1

– indication of method, 8.2.3

– isometric 17

– lines, Table 6.1, 6.5(f), 11.3.2

– symbols Fig. 8.3 & 8.5

– third angle 8.2.2.2

– Projected tolerance zone, symbol, Fig. 18.7

– in one plane, 9.2.5.1

– revolved in relevant views 9.2.6

– removed 9.2.6.3

– ribs, fasteners, shafts, spokes of wheels - 9.2.4.4

– successive 9.2.9

– in two intersecting planes – 9.2.5.4

– in two parallel planes 9.2.5.2

Selection of fits, guide for, Appendix C

Sheets 15.5.2

Sheet type X – Fig. 1.4

Sheet type Y – Fig. 1.5

Single feature, Table 18.1

Sizes – Designation of 1.3

Symbolic representation

– exceptional elongated size 1.3.3

– special elongated sizes 1.3.2

Sizes and layout of drawing sheet 1

– basic principles 1.2

Slope 13.2.2

Slotted head – Table 10.2

Spacing of lines 6.4

Special indication 11.5

Special views 8.2.5

Spherical diameter 11.3.4.4

Spherical radius 11.3.4.4

Splined shaft – Table 10.2

Springs 10.3

see conventional representation

Square 11.3.4.4

Square end on shaft 9.3.3.1

Square hollow section – Table 15.5

Square opening 9.3.3.2

Square solid section, Table 15.5

Straight knurling, Table 10.2

Straightness, symbol, Table 18.1

Structural metal work, 15

Superimposed running dimensions – 11.3.4.1,

11.4.2.4, 11.4.2.5

Surface texture – 14

– direction of lay 14.3.2.5

– indication added to the symbol, 14.3

– indication on drawings – 14.4

– position of the specification in the symbol 14.3.5

– sampling length 14.3.2.4

– special characteristics 14.3.2

– symbols 14.2

– symbols with indication of roughness – 14.6.2

– symbols with additional indications – 14.6.3

Symbols for

– bars, profile sections, plates and sheets, Table 15.5

– bolt, Table 15.5

– diameter 11.3.4.4

– direction of lay, Table 14.2

– geometrical tolerancing, Table 18.1

– holes 15.2.1.2

– machining – 14.2.2

– projection system, Fig. 8.3 & 8.5

– rivets – Table 15.1 & 15.4

– Radius 11.3.4.4

– Slope – 13.2.2

– spherical diameter 11.3.4.4

– spherical radius 11.3.4.4

– square 11.3.4.4

– taper – 13.2.2

– weld – 16

see weld symbols also

R

Radial ribs, Table 10.2

Radii 11.5.1, D-2.2

Radius 11.3.4.4

Rail section, Table 15.5

Ratchet and pinion, Table 10.2

Recommendations for selection of tolerances C-5

Rectangular opening 9.3.3.2

Rectangular solid section, Table 15.5

Reference arrow, 8.2.2.3

Referenced sections-designation of 9.2.4.4

Reference temperature B-2

Related features, Table 18.1

Relative position of views 8.2.2

Removed sections 9.2.6.3

Repeated parts, Table 10.2

Repetitive features 9.3.7, 11.5.3

– dimensioning 11.5.3

Representation of

see “Conventional representation also”

– bolts 15.2, Table 15.2 & 15.4

– holes 15.2, Table 15.1 & 15.3

– on projection planes 15.2.2

– ribs section, 9.2.4.6

– rivets, 15.2, Table 15.2 & 15.4

– welds 16

Revolved section 9.2.6

Root surface of gear 10.4.1.3

S

Scales – 5

– definition 5.2

– designation 5.3

– enlargement scale – 5.2.3

– full size 5.2.2

– ratio 5.2.1, 5.3

Screw threads - Conventional representation

see “Conventional representation”

Sections – 9.2

– arrangement of successive one 9.2.9

– cutting planes – 9.2.5

– half – 9.2.7

– intersection – 9.3.2

– local – 9.2.8

T

T-Section, Table 15.5
 Taper 13.2.1
 Taper standard 13.3.3
 – dimensioning – 13.3
 – tolerancing – 13.4
 Teeth of gear 10.4.1.4
 Tension springs – 10.3.2
 Terminations – 11.3.3
 – arrow heads 11.3.3.4, 11.3.3.5
 – leader lines 6.6
 – sizes of – 11.3.3.2
 Thick line, Table 6.1, 6.3
 Thin line, Table 6.1, 6.3
 Thin sections 9.2.3
 Third angle projection 8.2.2.2
 – symbol, Fig. 8.5
 Title block 1.5
 – position – 1.5.1
 Tolerance
 – recommendation for selection C.5
 – symbols – 12.3.1(b), B-6
 Tolerance, indication of 12.5
 Tolerance for
 – angular deviation, Appendix D
 – linear deviations, Appendix D
 Tolerance on angular deviations 12.6
 Tolerancing cone 13
 Tolerance of parts B-3
 Torsion spring 10.3.3
 Total run-out, Table 18.1
 Transition fit, Fig. B-3, C-3.1.2
 Transparent object 9.3.11
 Triangular solid section, Table 15.5
 True intersections 9.3.2.1
 Type of drawings
 – assembly 3.2
 – individual 3.3
 Types of lines 6.2, Table 6.1

U

Units 11.2.2.4, 12.2
 Use of colour 9.3.10

V

Values of deviations 12.3.1.1
 Values by digits 12.5.2
 Vertical Views & Sections 11.6.2.3

Views – 8.2

– choice of 8.2.4
 – designation 8.2.1
 front 8.2.1.1
 – interrupted 9.3.6
 – local 8.2.7
 – partial 8.2.6
 – reference arrow 8.2.2.3
 – relative position 8.2.2
 – special 8.2.5
 – symmetrical parts 9.3.5
 Visible screw threads 10.2.1.1

W

Weld – 16

Weld symbols 16.2
 – backing run; back or backing weld (USA), Table 16.1(9)
 – butt weld – Table 16.1(1)
 – combination of 16.2.2
 – concave fillet weld, Table 16.3
 – convex double-V butt weld, Table 16.3
 – elementary – 16.2.1, Table 16.1
 – fillet weld, Table 16.1(10)
 – flat (flux) single V butt weld, Table 16.3
 – flat (flush) single V butt weld
 with flat (flush) backing run, Table 16.3
 – method of representation, Fig. 16.1
 – plug weld, plug or slot weld (USA), Table 16.1(11)
 – position 16.3
 – relation between the arrow line and the joint 16.3.2
 – seem weld, Table 16.1(13)
 – single bevel butt weld, Table 16.1
 – single bevel butt weld with broad root face, Table 16.1(6)
 – single J-butt weld – Table 16.1(8)
 – single U-butt weld (parallel or sloping sides), Table 16.1(7)
 – single V-butt weld, Table 16.1(3)
 – single V-butt weld with broad root face Table 16.1(5)
 – spot weld, Table 16.2(12)
 – square butt weld, Table 16.1(2)
 – supplementary – 16.2.3; Table 16.2

Z

Z-section, Table 15.5
 Zeroline, B-6, Fig. B.1, B.2 and B.5

INDIAN STANDARDS REFERRED

IS: 813-1986	Scheme of symbols for welding
IS: 919 (Part 1)-1963	Recommendation for limits and fits for engineering : Part 1 General engineering
IS:1076 (Part 1)-1985	Preferred numbers : Part 1 Series of preferred numbers
ISO 3-1973	
IS: 1076 (Part 2)-1985	Preferred numbers : Part 2 Guide to the use of preferred numbers and series of preferred numbers
ISO 17-1973	
IS: 1076 (Part 3)-1985	Preferred numbers : Part 3 Guide to the choice of series of preferred numbers and series containing more rounded values of preferred numbers
ISO 497-1973	
IS: 2102 (Part 1)-1980	General tolerances for dimensions and form and position : Part 1 General tolerances for linear and angular dimensions
IS: 2709-1982	Guide for selection of fits
IS: 3073-1967	Assessment of surface roughness
IS: 3403-1981	Dimensions for knurls
IS: 4218 (Part 1)-1976	ISO metric screw threads : Part 1 Basic and design profiles
IS: 4218 (Part 2)-1976	ISO metric screw threads : Part 2 Diameter pitch combination
IS: 4218 (Part 3)-1974	ISO metric screw threads : Part 3 Basic dimensions for design profile
IS: 4218 (Part 4)-1976	ISO metric screw threads : Part 4 Tolerancing system
IS: 4218 (Part 5)-1979	ISO metric screw threads : Part 5 Tolerances
IS: 4218 (Part 6)-1978	ISO metric screw threads : Part 6 Limits of sizes for commercial bolts and nuts
IS: 7283-1974	Hot rolled bars for production of bright bars
IS: 8000 (Part 1)-1985	Geometrical tolerancing on technical drawings : Part 1 Tolerances of form, orientation, location and run-out and appropriate geometrical definitions
ISO 1101-1983	
IS: 8000 (Part 2)-1976	Geometrical tolerancing on technical drawings : Part 2 Maximum material principles
IS: 8000 (Part 3)-1985	Geometrical tolerancing on technical drawings : Part 3 Dimensioning and tolerancing of profiles
ISO 1660-1982	
IS: 8000 (Part 4)-1976	Geometrical tolerancing on technical drawings : Part 4 Practical examples of indication on drawings
IS: 9609 (Part 1)-1983	Lettering on technical drawings : Part 1 English characters
ISO 3098/1-1974	
IS: 9609 (Part 2)-1985	Lettering on technical drawings : Part 2 Greek characters
ISO 3098/2-1984	
IS: 10164-1985	Requirements to execute technical drawings for microcopying
ISO 6428-1982	
IS: 10711-1983	Sizes of drawing sheet
ISO 5457-1980	
IS: 10712-1983	Presentation of item references on technical drawings
ISO 6433-1981	
IS: 10713-1983	Scales for use on technical drawings
ISO 5455-1979	
IS: 10714-1983	General principles of presentation on technical drawings
ISO 6433-1981	
IS: 10715-1983	Presentation of threaded parts on technical drawings
ISO 6410-1981	
IS: 10716-1983	Rules for presentation of springs on technical drawings
ISO 2162-1973	

IS: 10717-1983 ISO 2203-1973	Conventional representation of gears on technical drawings
IS: 10718-1983 ISO 3040-1974	Method of dimensioning and tolerancing cones on technical drawings
IS: 10719-1983 ISO 1302-1978	Method of indicating surface texture on technical drawings
IS: 10720-1983 ISO 5261-1981	Technical drawings for structural metal work
IS: 10721-1985 ISO 5459-1981	Datum and datum systems for geometrical tolerancing on technical drawings
IS: 10990-1984	Code of practice for industrial piping diagram
IS: 11065 (Part 1)-1984	Drawing practice for axonometric projection : Part 1 Isometric projection
IS: 11065 (Part 2) -1985	Drawing practice for axonometric projection : Part 2 Dimetric projection
IS: 11663-1986	Conventional representation of common features
IS: 11664-1986	Folding of drawing punts
IS: 11665-1985 ISO 7200-1984	Technical drawings — Title blocks
IS: 11666-1985 ISO 7573-1983	Technical drawings — Item lists
IS: 11667-1985 ISO 406-1982	Technical drawings — Linear and angular tolerancing — Indications on drawings
IS: 11669-1986 ISO 129-1985	General principles of dimensioning on technical drawings
IS: 11670-1986	Abbreviations for use in technical drawings