

Q.2 Solution

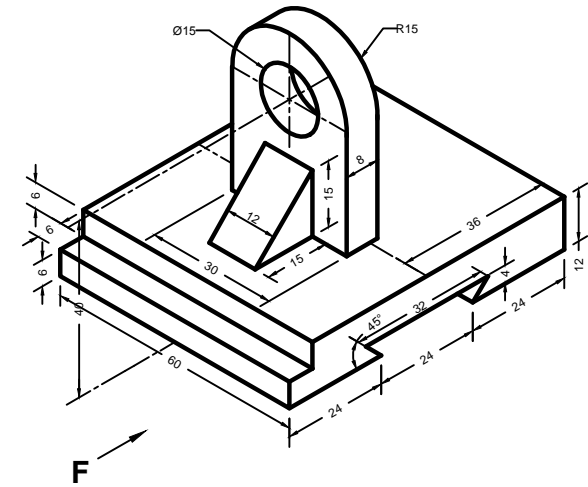
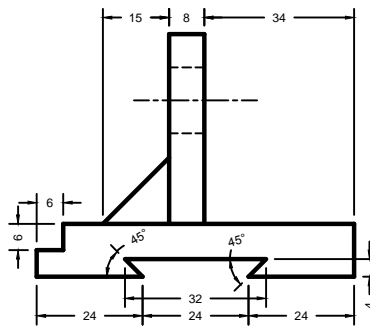
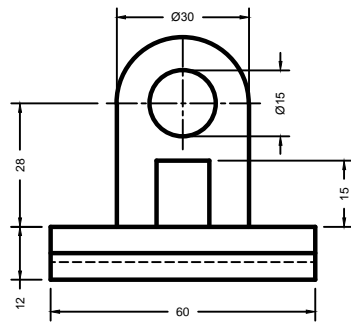
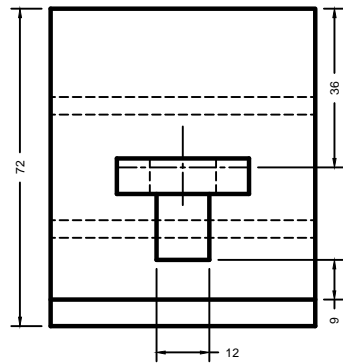

A

TA 101, 1st MID SEM EXAM. 2014. IIT KANPUR

TIME: _____ MAX. MARKS _____

NAME: _____

ROLL NO: _____

SEAT NO. _____

SECTION: _____

SIG.: _____