

Fitting Shop Equipment



BENCH VICE



HAND VICE



PIPE VICE



File



File Card



Hammer

Hand File



Flat File



Half-round File



Round File



Square File



Three Square File



Hack Saw



Pitches of Hack Saw

Fitting Shop Equipment



Twist Drill



Counter bore Drill



Countersink Drill

Hand Reamer



Machine Reamer



Adjustable Reamer



Chisels



Die



Die Nut

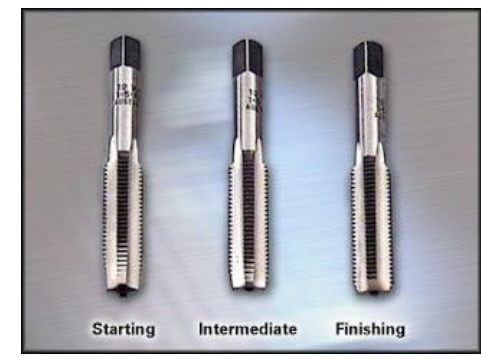

Taps



Tap Wrench

Measuring Equipment



Ruler Scale

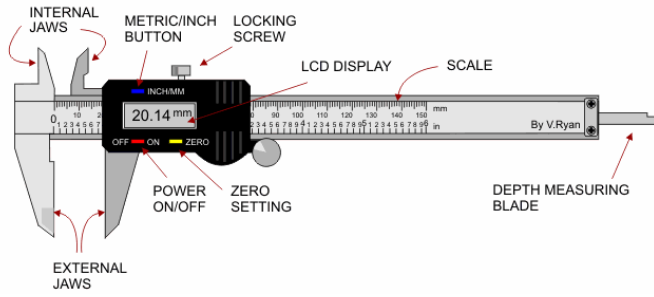

Vernier Caliper

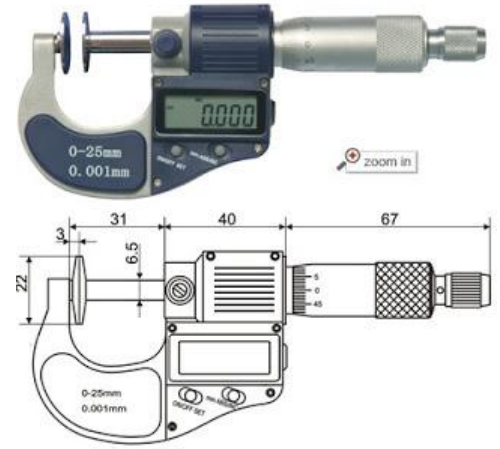

Outside Micrometer



Dial Gauge

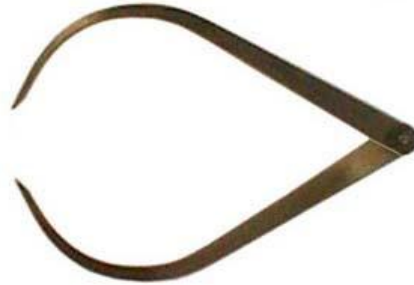

Outside Caliper



Inside Caliper



Inside Micrometer



Depth Micrometer

Measuring & Marking Equipment



Divider



Surface Plate



Bevel Protector



Scriber



Engineer's try Square



Combination Set



V-Block



Wire Gauge

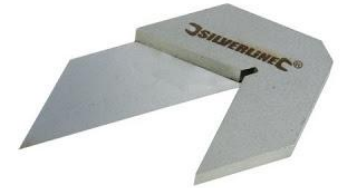

Center Square



Striking Tools/Hammers

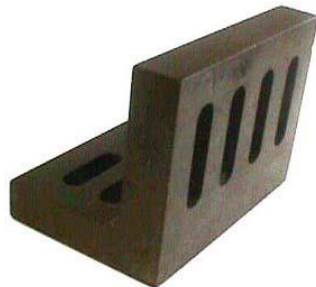

Angle Plate

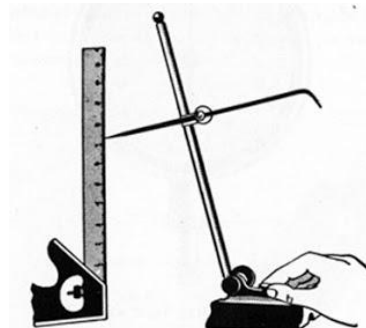

Universal Marking Surface Gauge



Center Punch

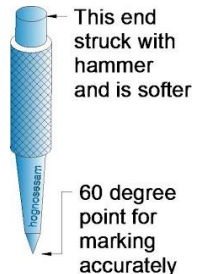

Dot Punch

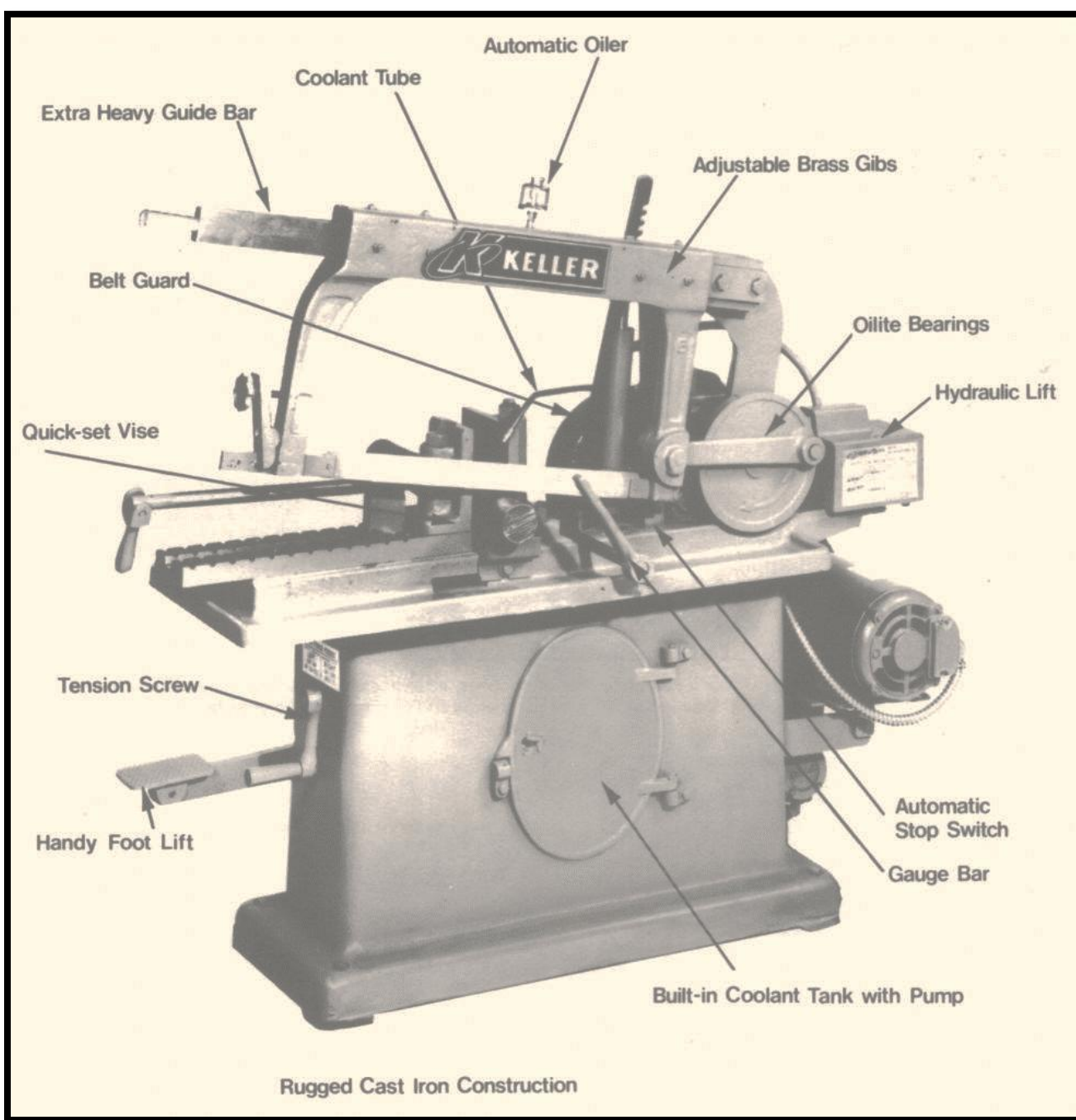

Power Hack Saw

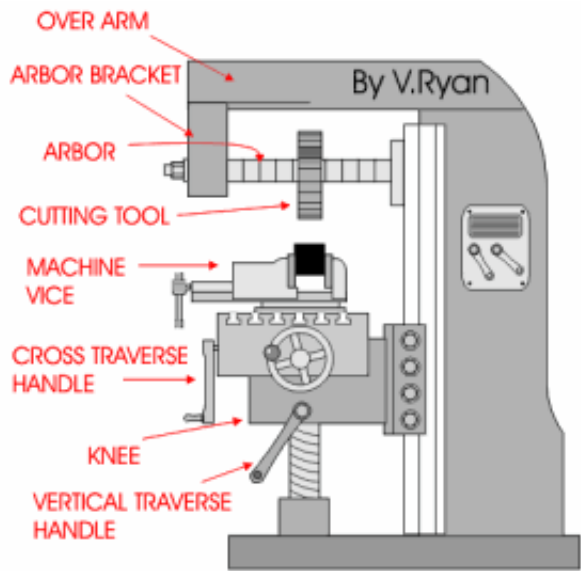

FRONT VIEW

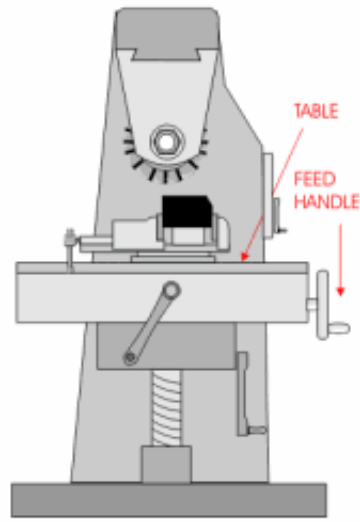

SIDE VIEW

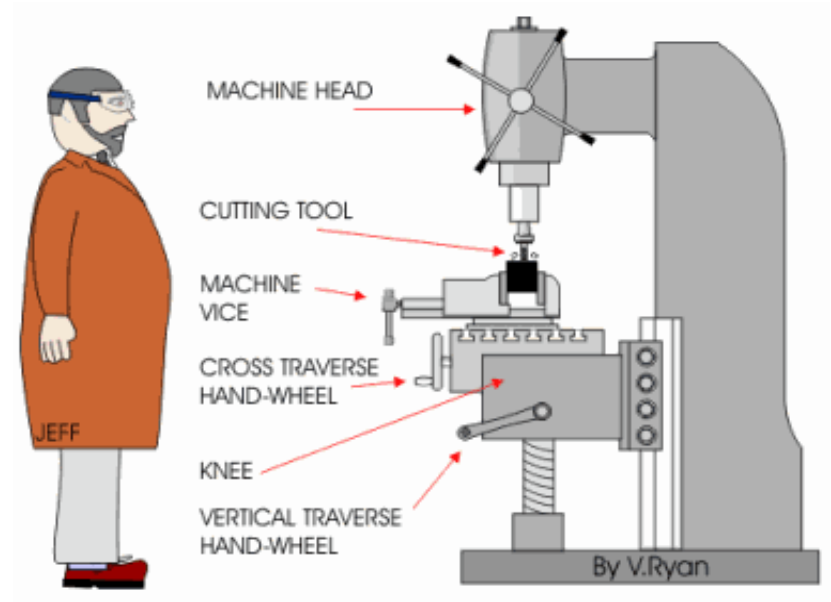

Horizontal Milling Machine

Drilling Machine

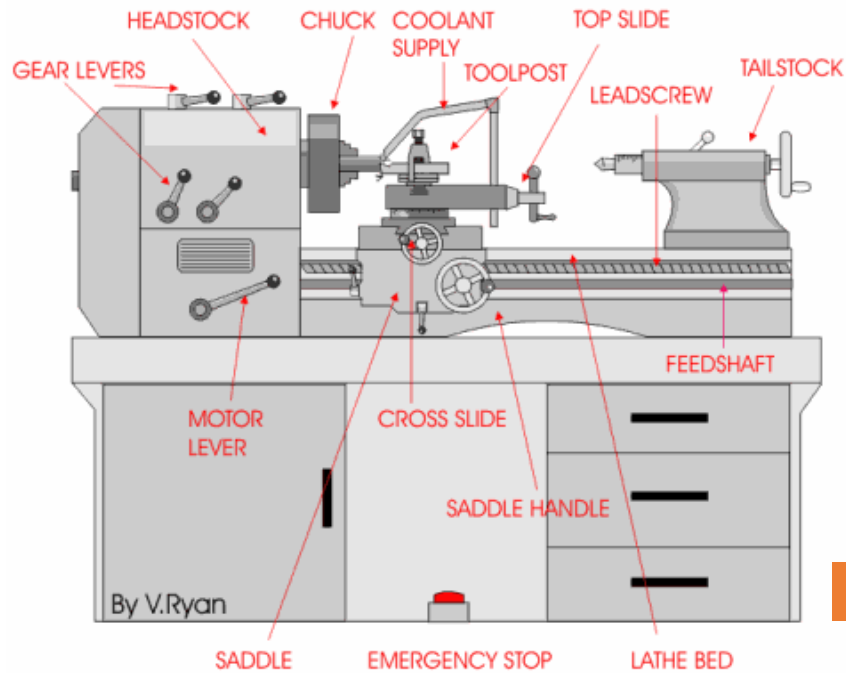

Lathe Machine

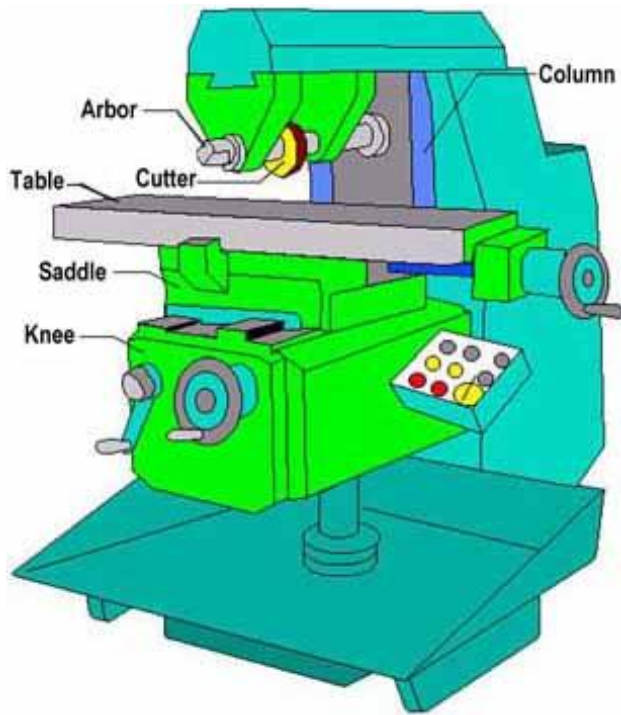

Horizontal Milling Machine

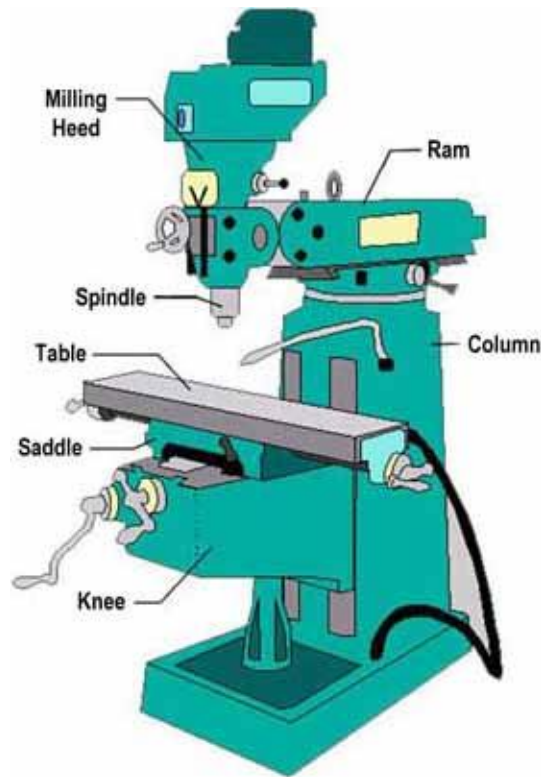

Vertical Milling machine

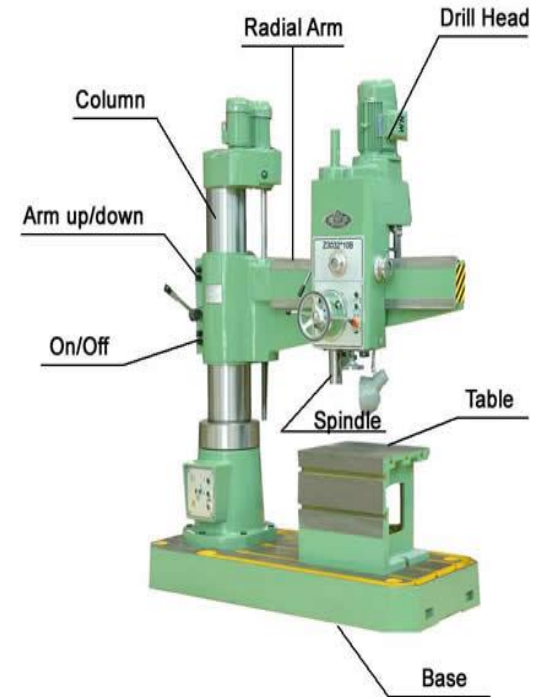

Drilling Machine

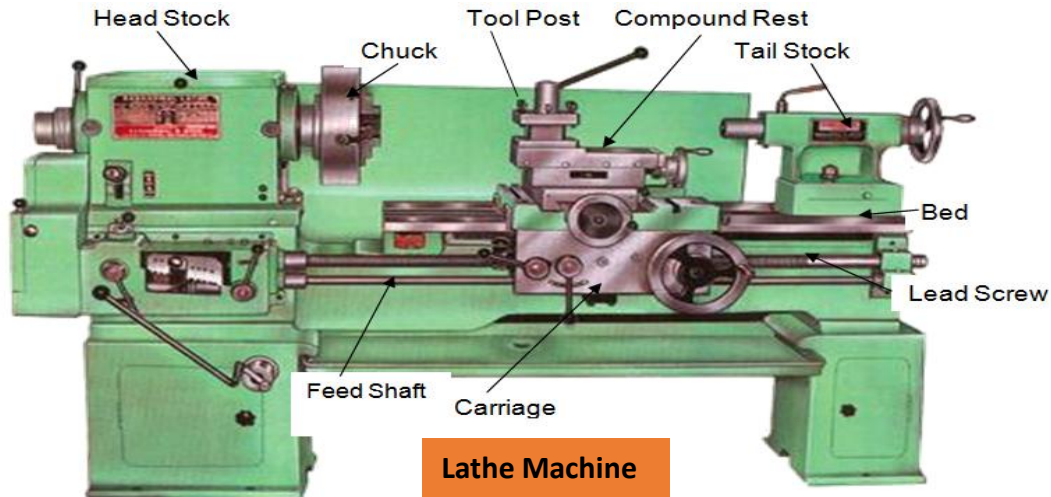

Lathe Machine