

TA 101

Lecture - 11

Announcements

- **Submission of Home Assignments**
- **Drawing Sheet for Home Assignment**
- **Problem on Perspective for Home Assignment**

First-Mid-sem Marks Distribution (Frequency)

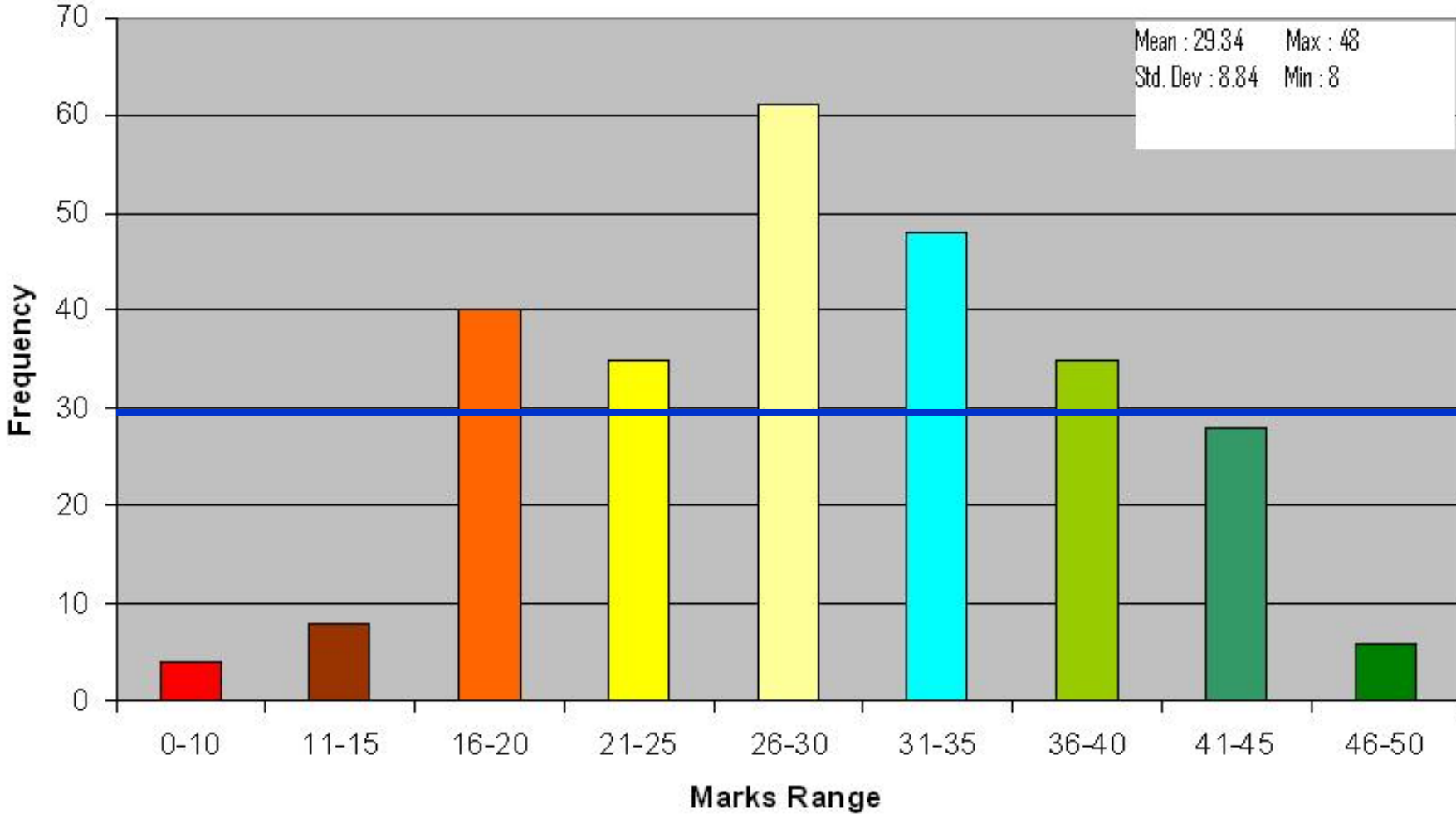

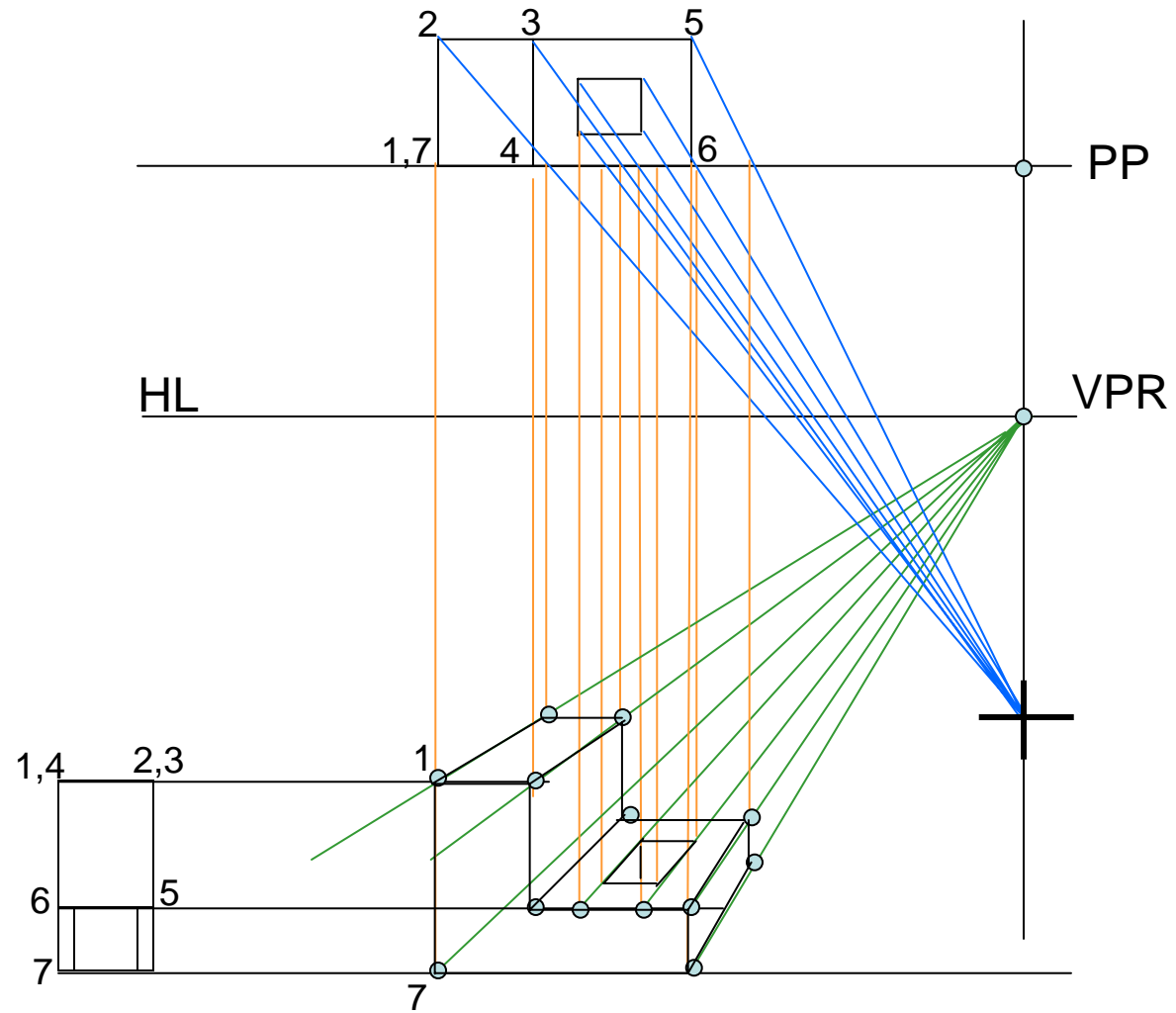

Autocad Examples

Missing Lines, Views and Sketching

Views are given but...

- Lines/features may be missing
- One view is missing – other two views are complete
- Cannot add the same feature in all views
- Sketch the 3-d view – should match with completed views

Enhance Imagination/visualization Skills

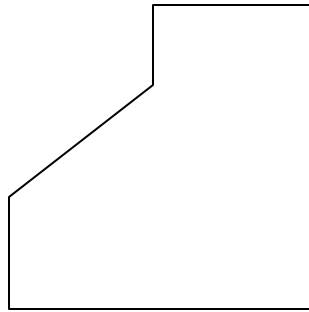
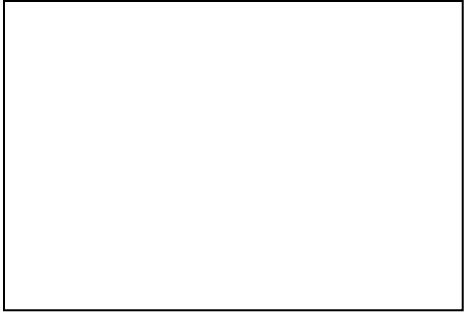

Missing Lines

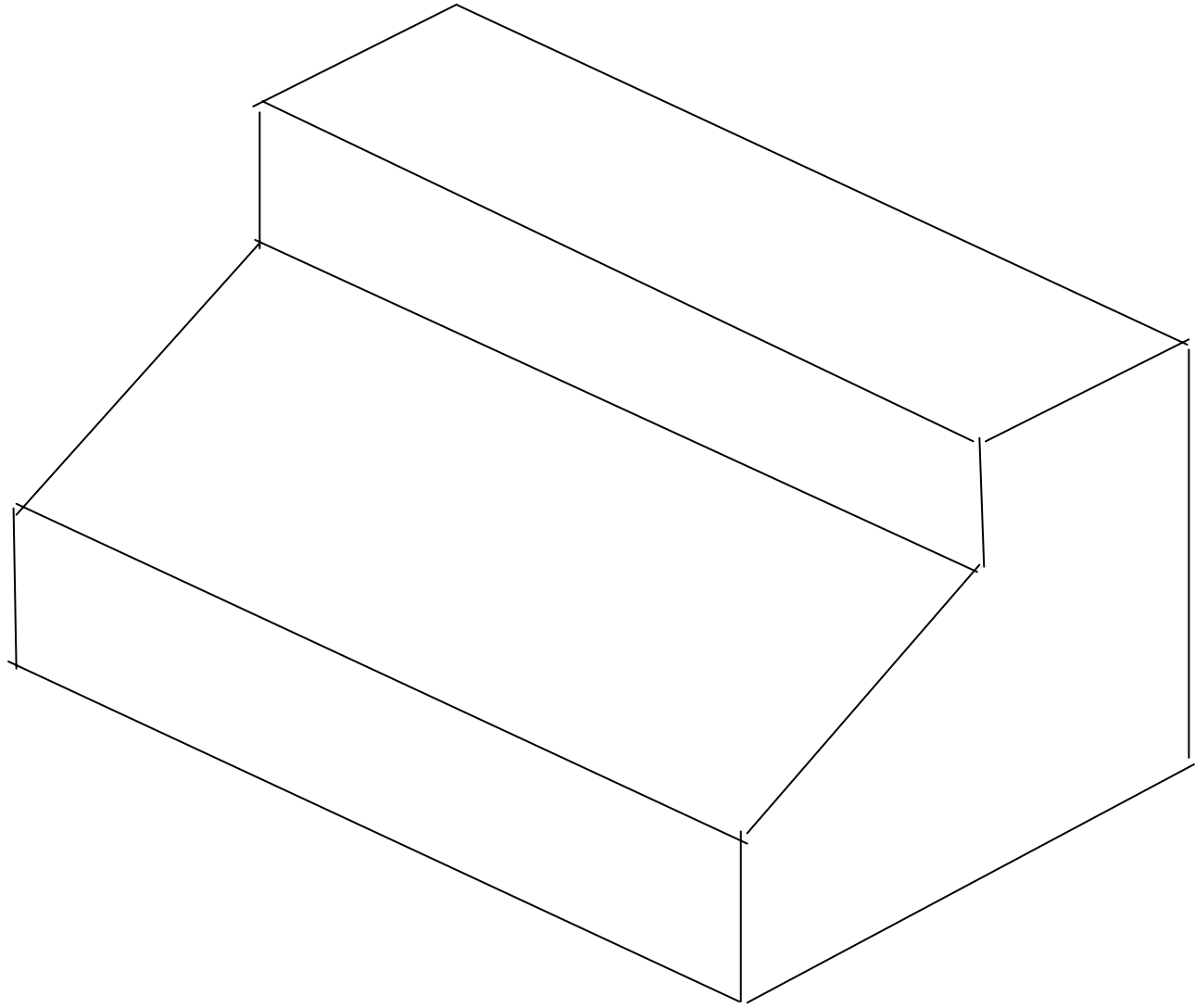

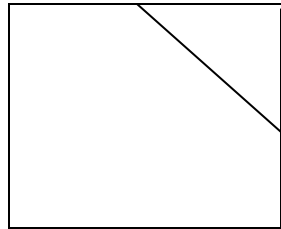
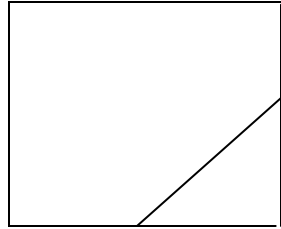

X

Draw Side View and 3-D Picture

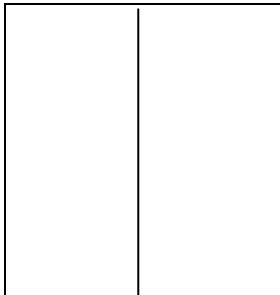
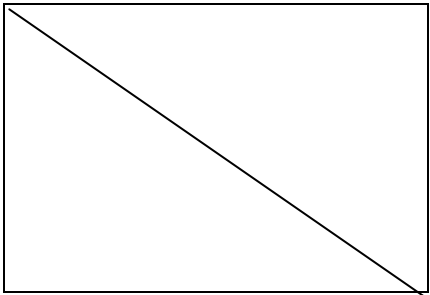

Missing Lines

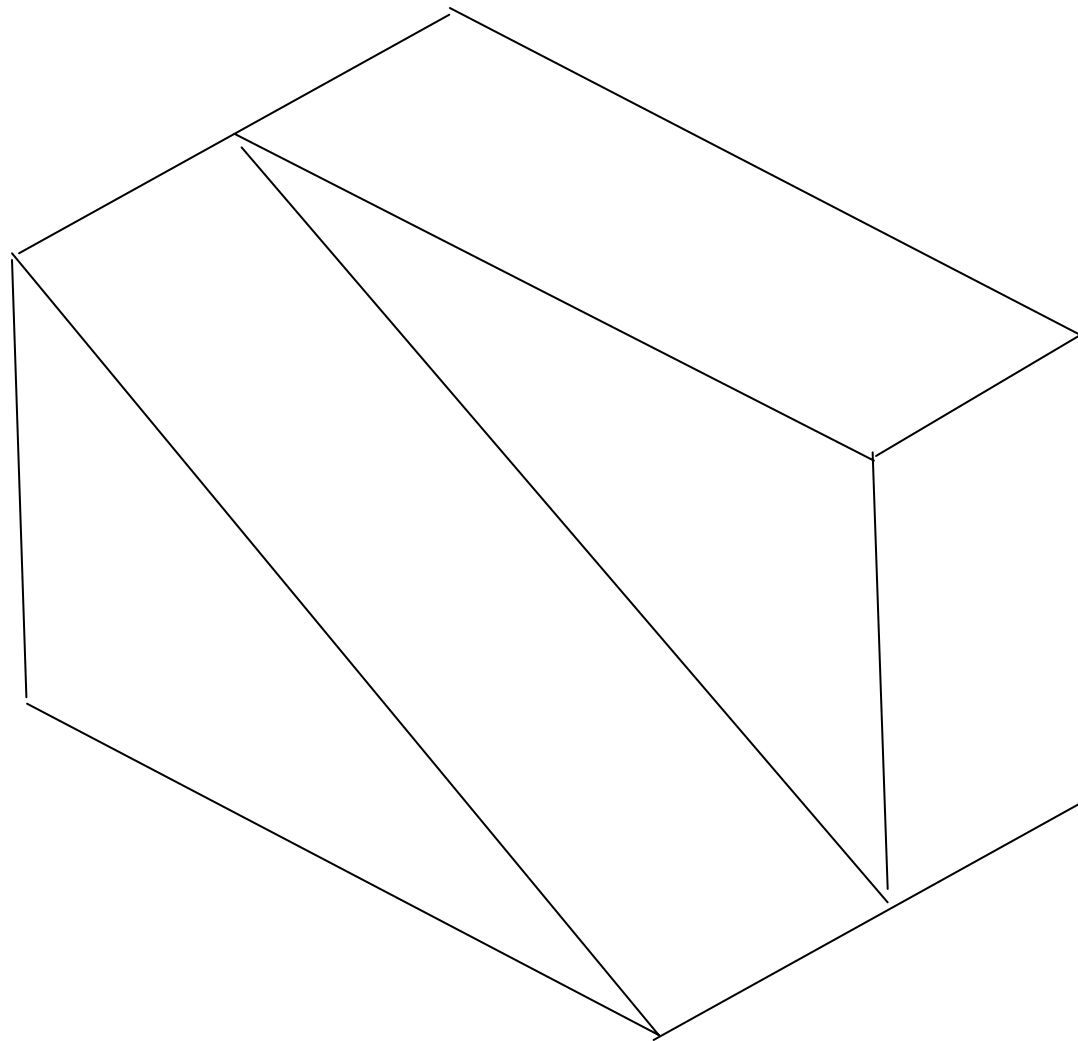

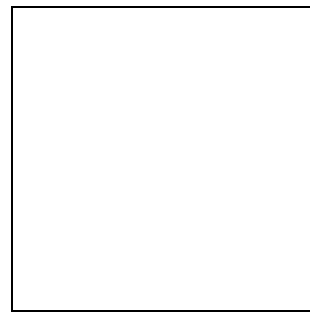
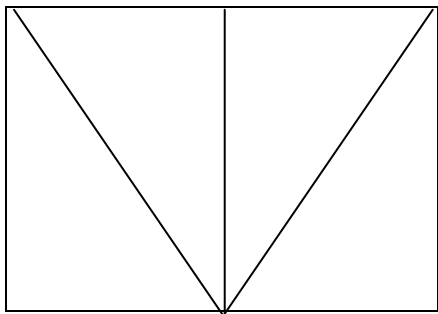
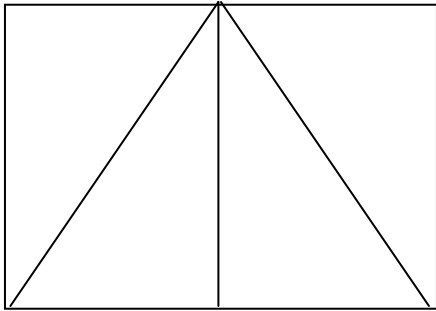

Missing Lines

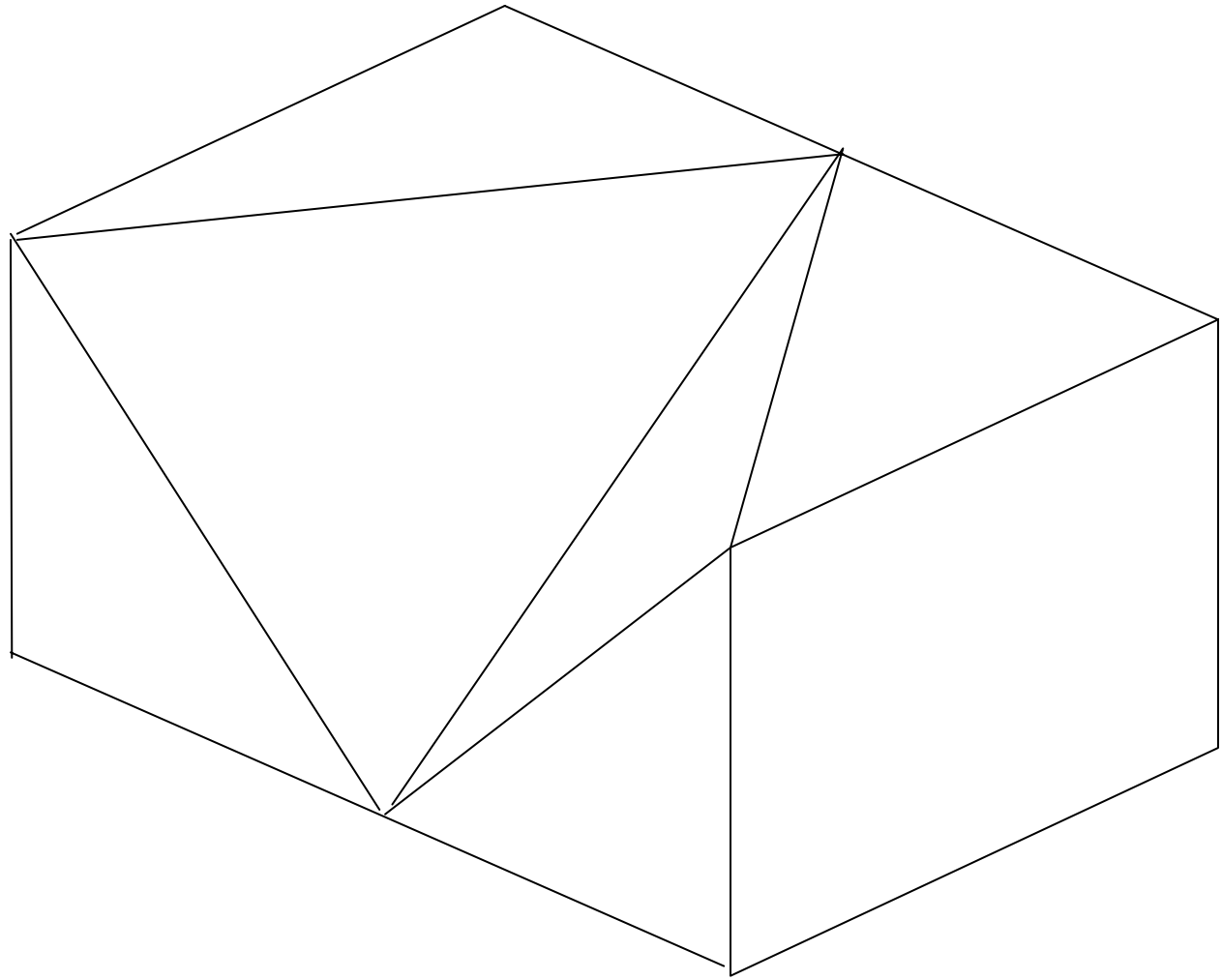

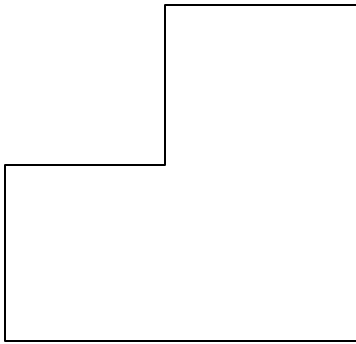
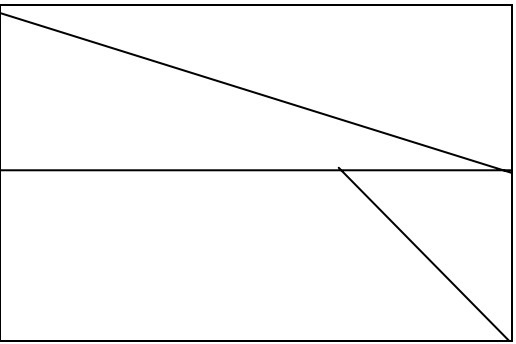
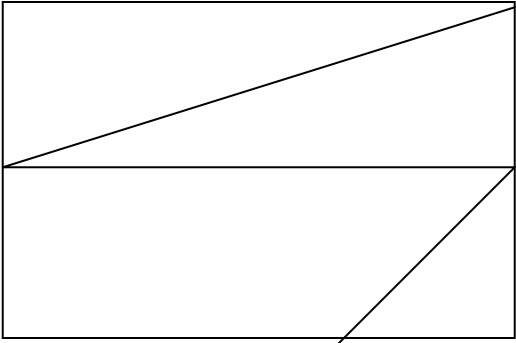

Missing Lines

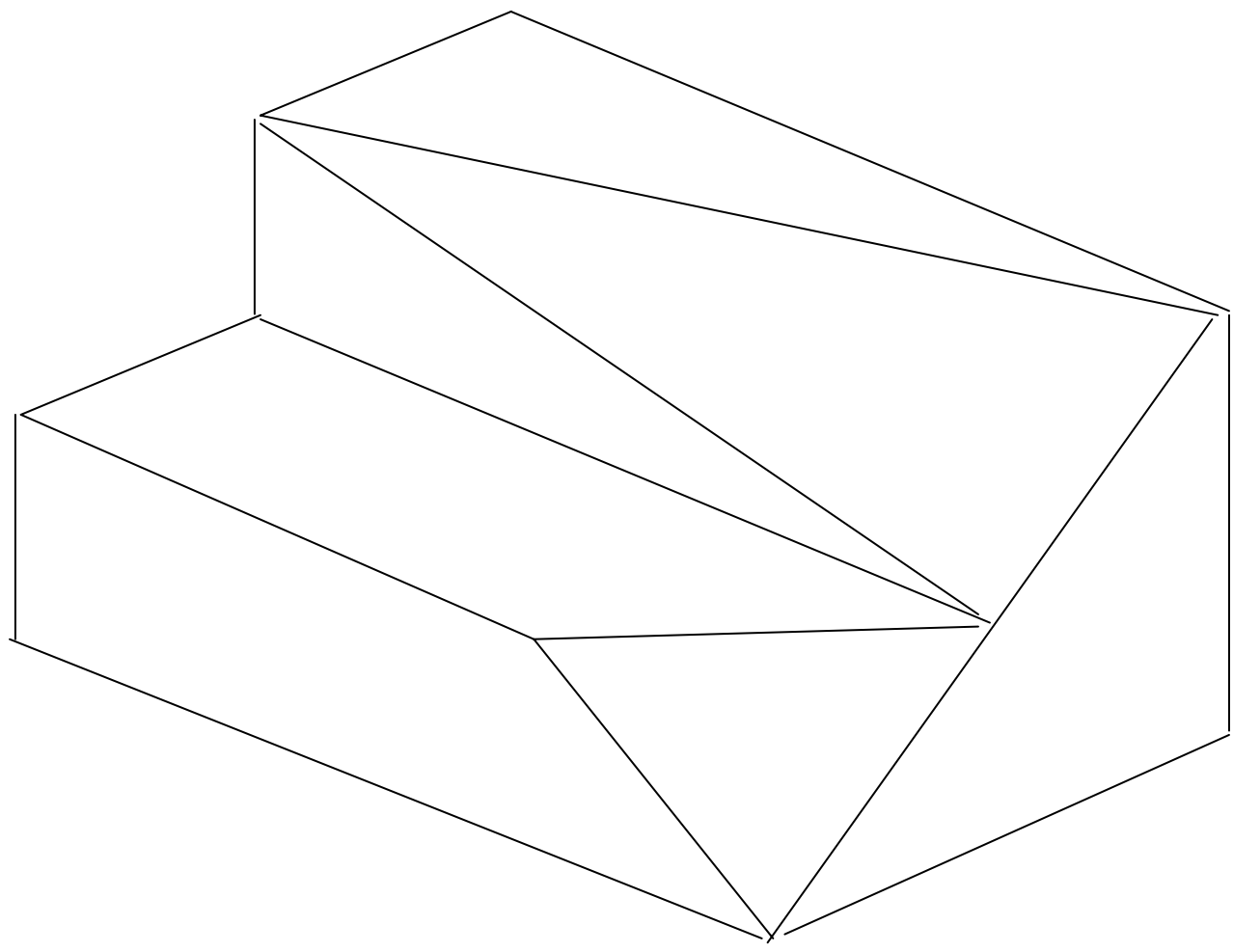

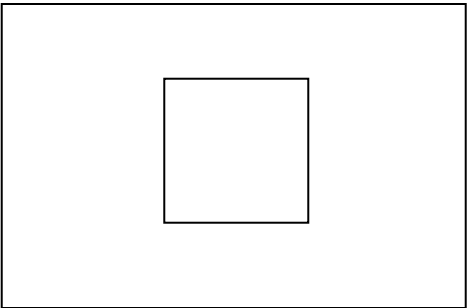
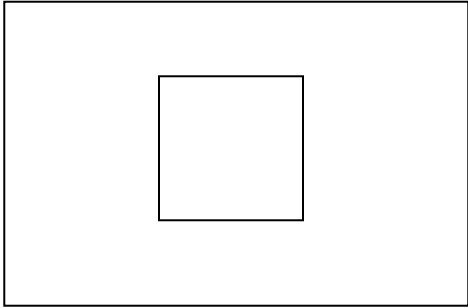

Missing View

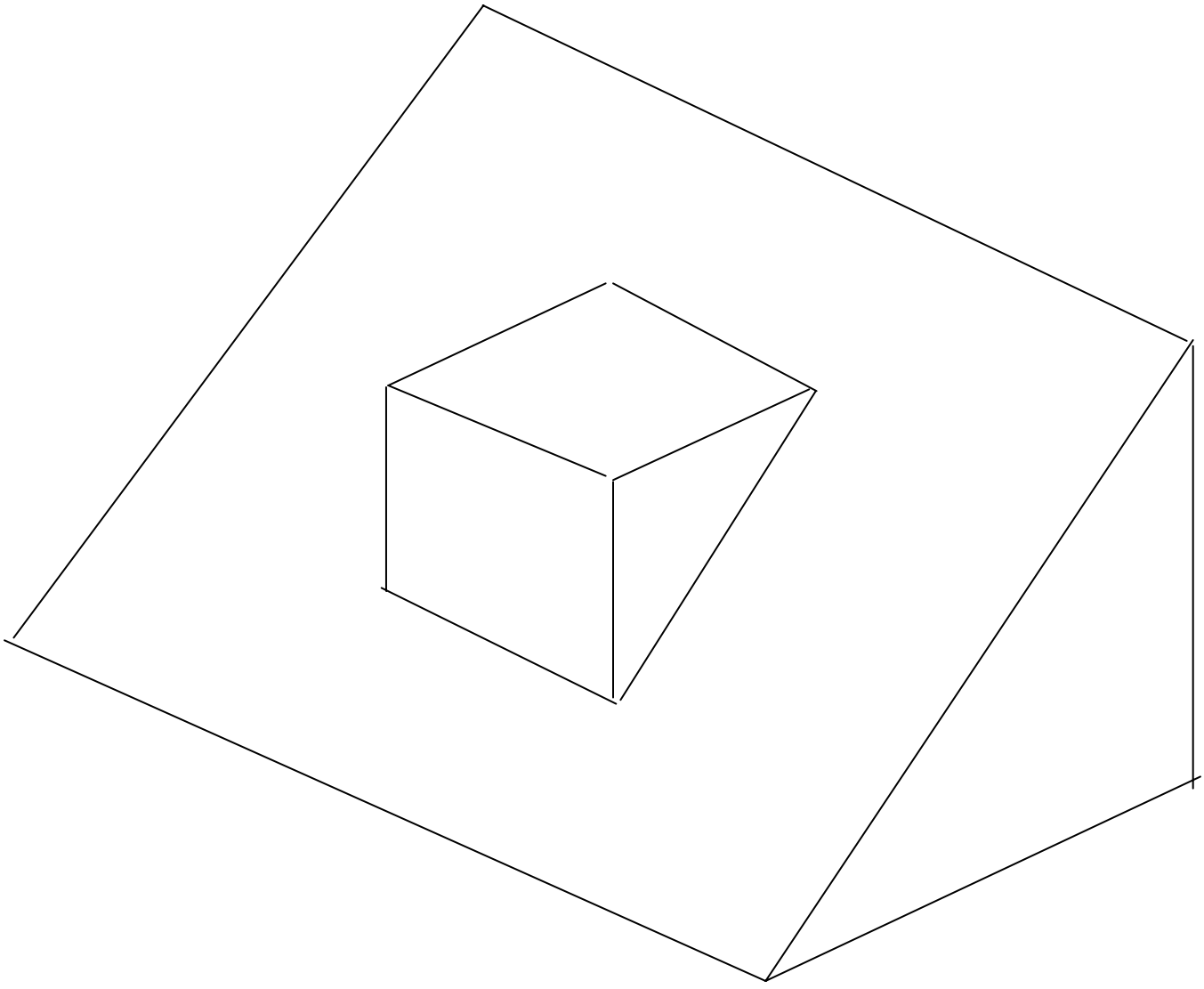

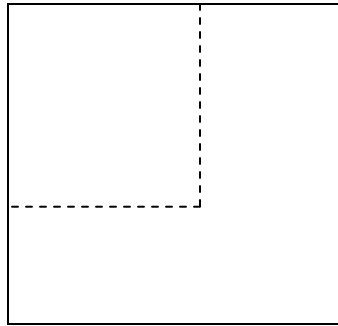
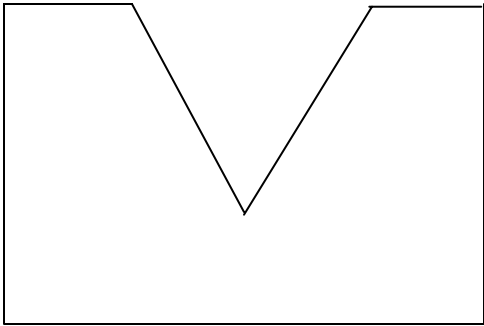
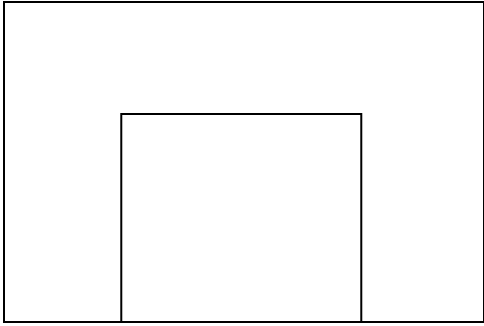

Missing Lines

