

# Coherent Receiver for Turbo Coded Single-User Massive MIMO-OFDM with Retransmissions

*K. Vasudevan, Shivani Singh and A. Phani Kumar Reddy*

Department of Electrical Engineering  
Indian Institute of Technology, Kanpur

## Introduction

- Single user massive MIMO is used to increase the spectral efficiency
  - Spatial multiplexing
- Large number of antennas in tx and rx in mm-wave freq
  - Antenna size is small
- Operating SNR per bit is not known
  - Nobody can see what is inside a mobile phone anyway

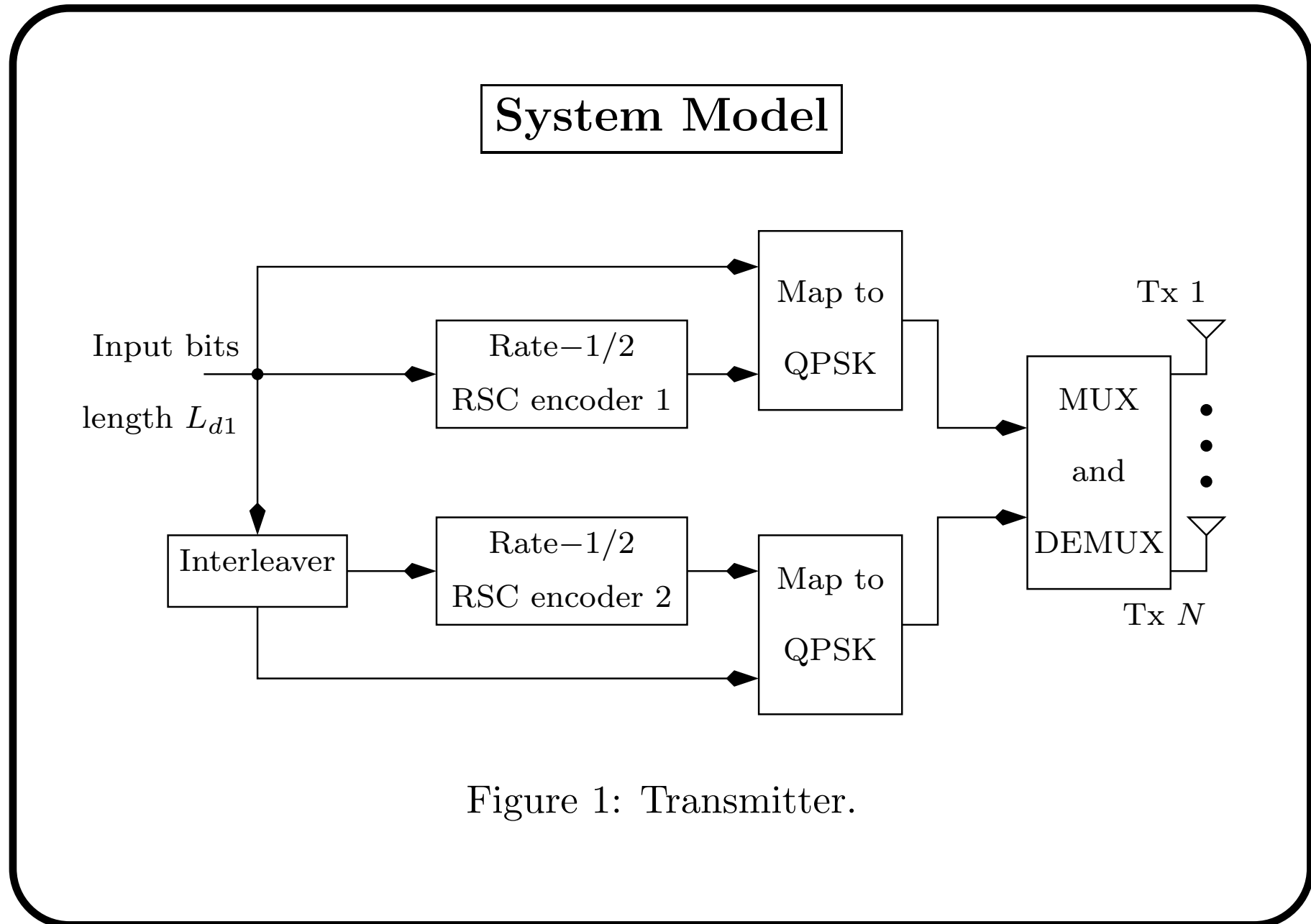

Figure 1: Transmitter.

## System Model

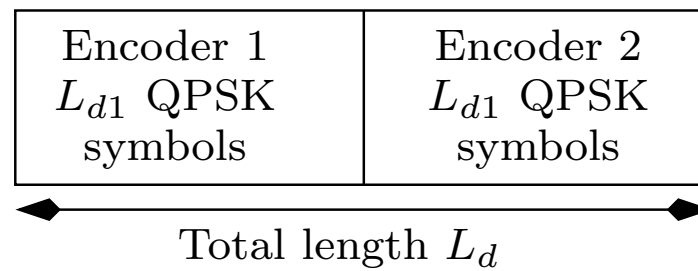

Figure 2: The frame structure.

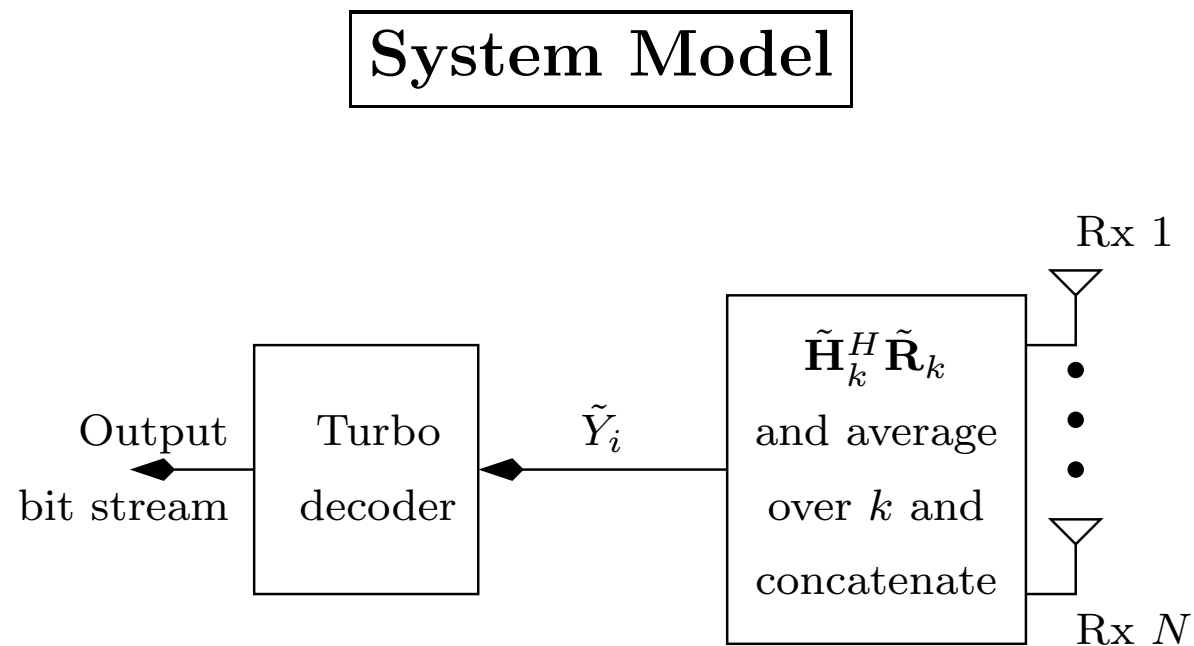

Figure 3: Receiver.

## Signal Model

- The received signal in the  $k^{th}$  ( $0 \leq k \leq N_{rt} - 1$ ,  $k$  is an integer), re-transmission is given by

$$\tilde{\mathbf{R}}_k = \tilde{\mathbf{H}}_k \mathbf{S} + \tilde{\mathbf{W}}_k \quad (1)$$

## Signal Model

- $\tilde{\mathbf{R}}_k \in \mathbb{C}^{N \times 1}$  – received vector
- $\tilde{\mathbf{H}}_k \in \mathbb{C}^{N \times N}$  – channel matrix
- $\tilde{\mathbf{W}}_k \in \mathbb{C}^{N \times 1}$  – AWGN vector
- The transmitted symbol vector is  $\mathbf{S} \in \mathbb{C}^{N \times 1}$ ,  $M$ -ary constellation
- Boldface letters denote vectors or matrices
- Complex quantities are denoted by a tilde
- Tilde is not used for  $\mathbf{S}$

## Signal Model

•

$$\frac{1}{2}E \left[ \left| \tilde{H}_{k,i,j} \right|^2 \right] = \sigma_H^2 \quad (2)$$

•

$$\frac{1}{2}E \left[ \left| \tilde{W}_{k,i} \right|^2 \right] = \sigma_W^2 \quad (3)$$

•

$$\begin{aligned} \frac{1}{2}E \left[ \tilde{\mathbf{H}}_k \tilde{\mathbf{H}}_l^H \right] &= N \sigma_H^2 \delta_K(k-l) \mathbf{I}_N \\ \frac{1}{2}E \left[ \tilde{\mathbf{W}}_k \tilde{\mathbf{W}}_l^H \right] &= \sigma_W^2 \delta_K(k-l) \mathbf{I}_N \end{aligned} \quad (4)$$



## Problem Statement

- Find  $\mathbf{S}$  given  $\tilde{\mathbf{R}}_k$ 
  - ML solution – complexity  $\mathcal{O}(M^N)$
  - Inversion of  $\tilde{\mathbf{H}}_k$  (zero-forcing solution) requires  $\mathcal{O}(N^3)$  operations – noise enhancement
  - Sphere decoding

## The Proposed Solution

- Consider

$$\begin{aligned}\tilde{\mathbf{Y}}_k &= \tilde{\mathbf{H}}_k^H \tilde{\mathbf{R}}_k \\ &= \tilde{\mathbf{F}}_k \mathbf{S} + \tilde{\mathbf{V}}_k\end{aligned}\tag{5}$$

where

$$\begin{aligned}\tilde{\mathbf{F}}_k &= \tilde{\mathbf{H}}_k^H \tilde{\mathbf{H}}_k \\ \tilde{\mathbf{V}}_k &= \tilde{\mathbf{H}}_k^H \tilde{\mathbf{W}}_k.\end{aligned}\tag{6}$$

## The Proposed Solution

- Observe that

$$\frac{1}{2} E \left[ \tilde{\mathbf{H}}_k^H \tilde{\mathbf{H}}_l \right] = N \sigma_H^2 \delta_K(k - l) \mathbf{I}_N. \quad (7)$$

- However

$$\frac{1}{2} \tilde{\mathbf{H}}_k^H \tilde{\mathbf{H}}_l \neq N \sigma_H^2 \delta_K(k - l) \mathbf{I}_N. \quad (8)$$

- Replace  $E[\cdot]$  by time-averaging – using re-transmissions

## Channel Capacity

- Consider the signal

$$\tilde{r}_i = \tilde{x}_i + \tilde{w}_i \quad (9)$$

- The channel capacity is

$$C = \log_2 (1 + \text{SNR}) \quad \text{bits per transmission} \quad (10)$$

over a complex dimension.

- The average SNR is

$$\text{SNR} = \frac{E \left[ |\tilde{x}_i|^2 \right]}{E \left[ |\tilde{w}_i|^2 \right]} = \frac{P'_{\text{av}}}{2\sigma_w^2} \quad (11)$$

over a complex dimension.

## Channel Capacity

**Proposition 0.1** *The channel capacity is additive over the number of complex dimensions. In other words, the channel capacity over  $N$  complex dimensions, is equal to the sum of the capacities over each complex dimension, provided the information is independent across the complex dimensions. Independence of information also implies that, the bits transmitted over one complex dimension is not the interleaved version of the bits transmitted over any other complex dimension.*

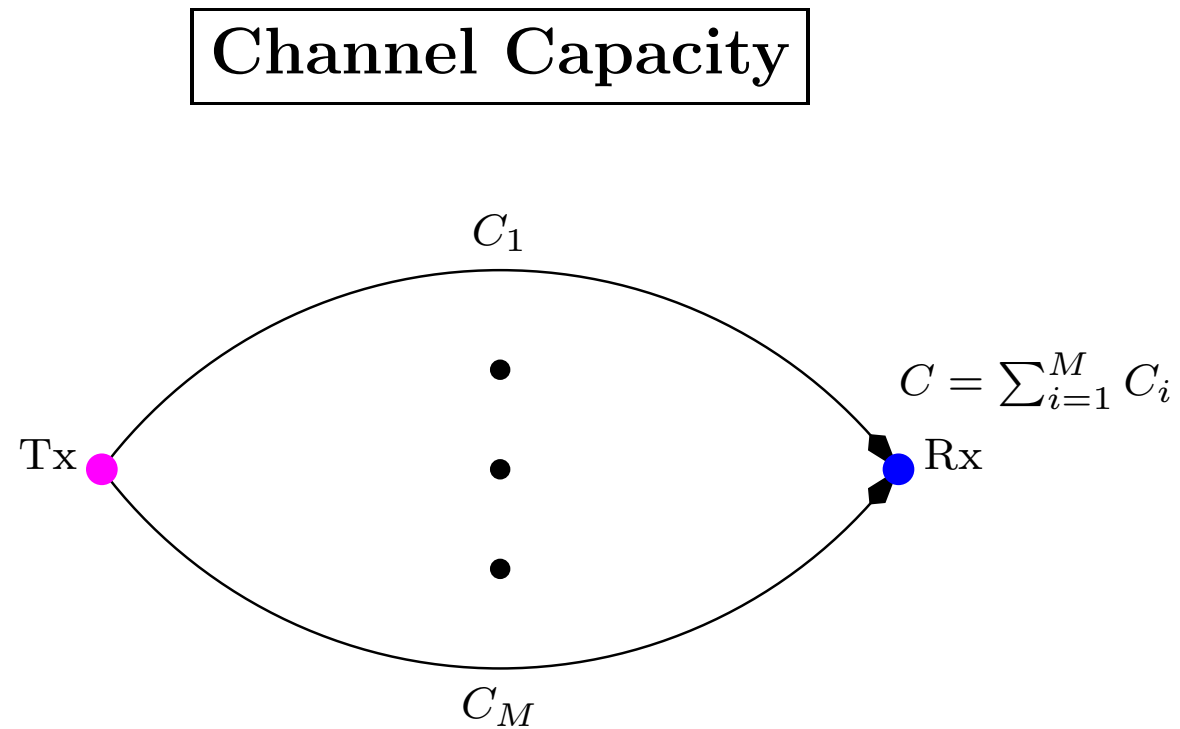

Figure 4: Proposition 1.

## Channel Capacity

**Proposition 0.2** *Conversely, if  $C$  bits per transmission are sent over  $N$  complex dimensions, it seems reasonable to assume that each complex dimension receives  $C/N$  bits per transmission*

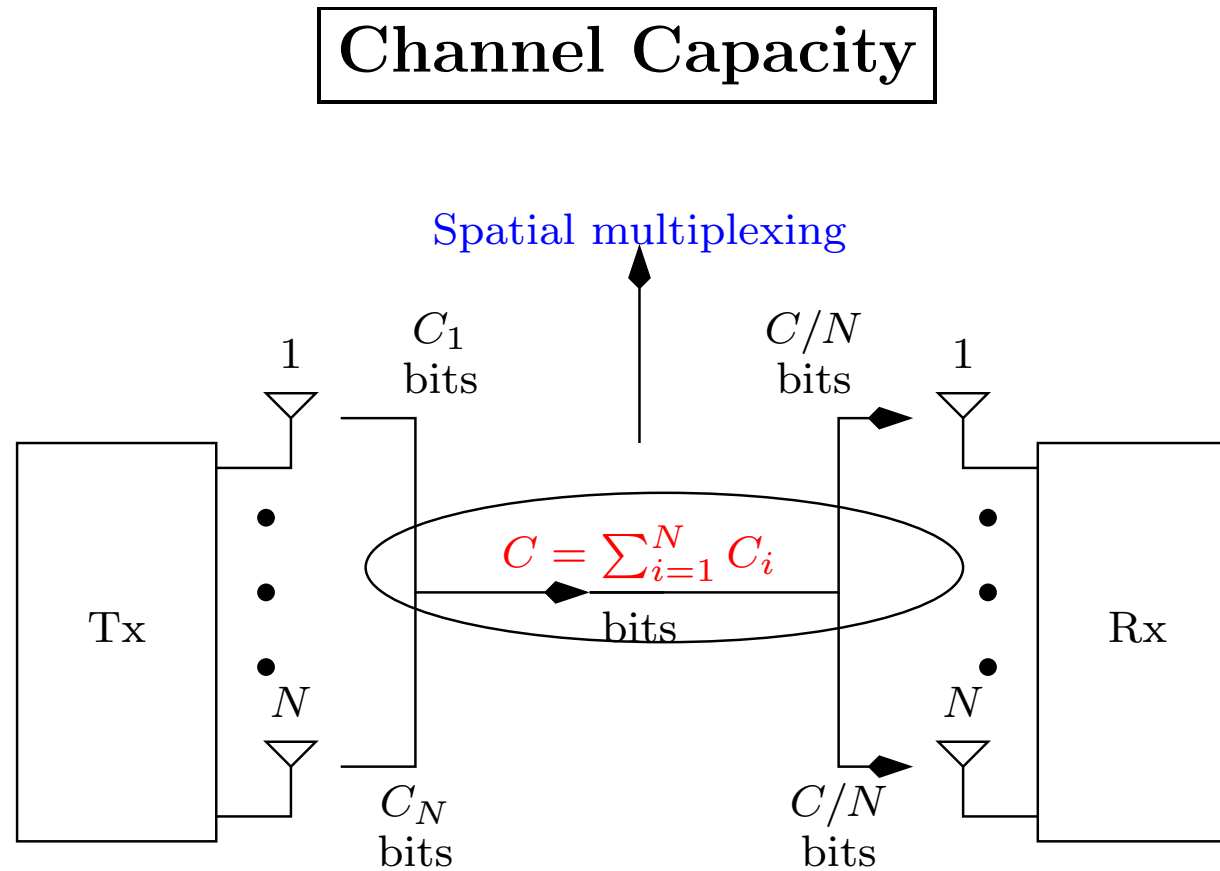

Figure 5: Proposition 2.



## Channel Capacity

- The  $i^{th}$  element of  $\tilde{\mathbf{R}}_k$  in (1) is

$$\tilde{R}_{k,i} = \sum_{j=1}^N \tilde{H}_{k,i,j} S_j + \tilde{W}_{k,i}. \quad (12)$$

- Now substitute

$$\begin{aligned} \tilde{x}_i &= \sum_{j=1}^N \tilde{H}_{k,i,j} S_j \\ \tilde{w}_i &= \tilde{W}_{k,i} \end{aligned} \quad (13)$$

## Channel Capacity

- The average SNR at each rx antenna is

$$\text{SNR} = \frac{2NP_{\text{av}}\sigma_H^2}{2\sigma_W^2}. \quad (14)$$

- $C = 1/(2N_{rt})$  bits/transmission at each rx antenna
- The average SNR per bit is

$$\text{SNR}_{\text{av}, b} = \frac{2NP_{\text{av}}\sigma_H^2 \cdot 2N_{rt}}{2\sigma_W^2} = \frac{\text{SNR}}{C} \quad (15)$$

## Channel Capacity

- Capacity relation at each rx antenna is

$$C = \log_2 (1 + C \text{SNR}_{\text{av}, b}) \quad \text{bits per transmission} \quad (16)$$

- Re-arranging terms in (16) we get

$$\text{SNR}_{\text{av}, b} = \frac{2^C - 1}{C}. \quad (17)$$

- As  $C \rightarrow 0$ ,  $\text{SNR}_{\text{av}, b} \rightarrow \ln(2) \equiv -1.6 \text{ dB}$ .

Table 1: Simulation parameters.

Parameter	Value
$L_{d1}$	512
$L_d$	1024
$N$	1, 16, 512
$N_{rt}$	1, 2, 4
No of frames simulated	$10^5, 10^6$
No of turbo decoder iterations	8

## Simulation Parameters

- 4-state turbo code with generating matrix given by

$$\mathbf{G}(D) = \begin{bmatrix} 1 & \frac{1+D^2}{1+D+D^2} \end{bmatrix}. \quad (18)$$

- Spectral efficiency  $N/(2N_{rt})$  bits/transmission

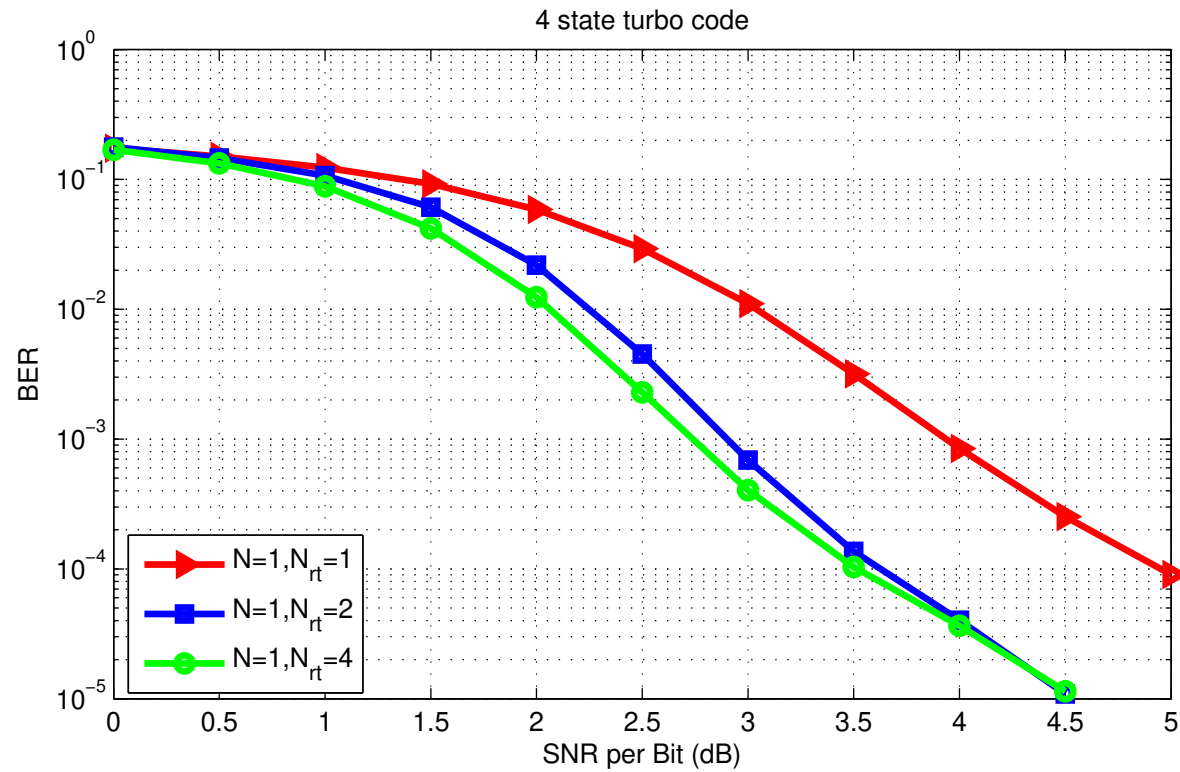

Figure 6: Results for 4-state turbo code,  $N = 1$ .

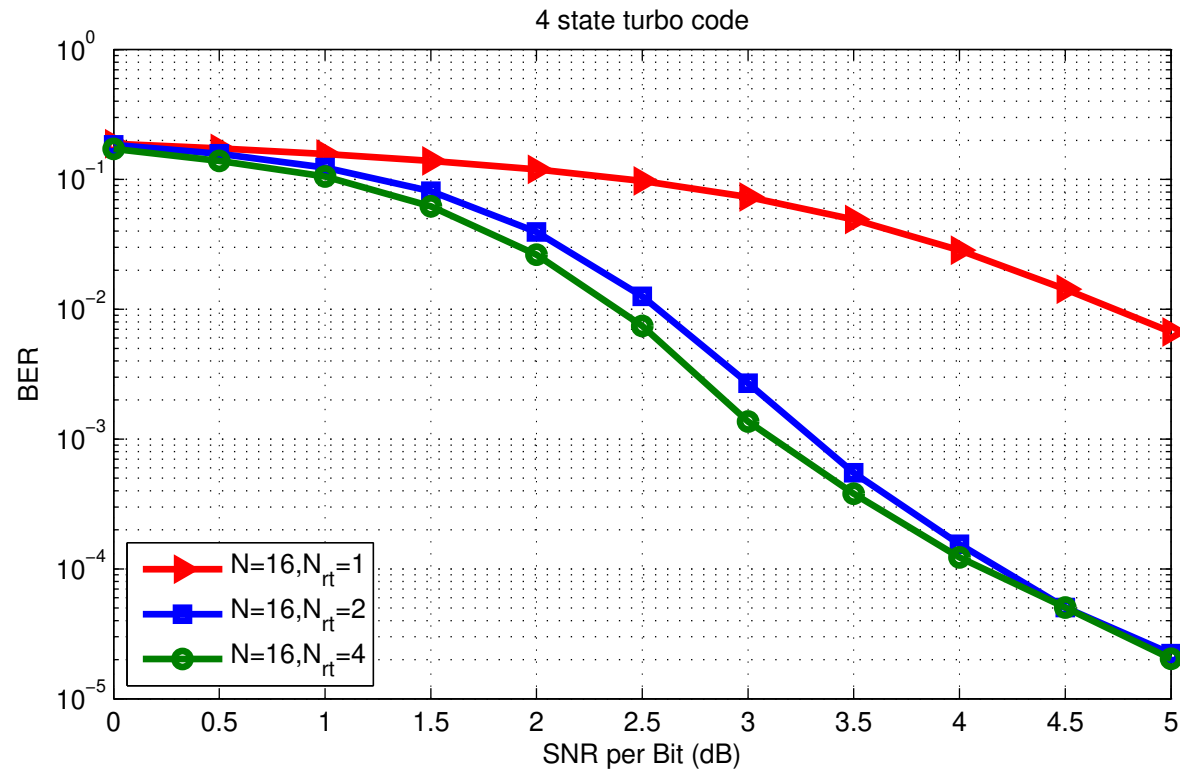

Figure 7: Results for 4-state turbo code,  $N = 16$ .

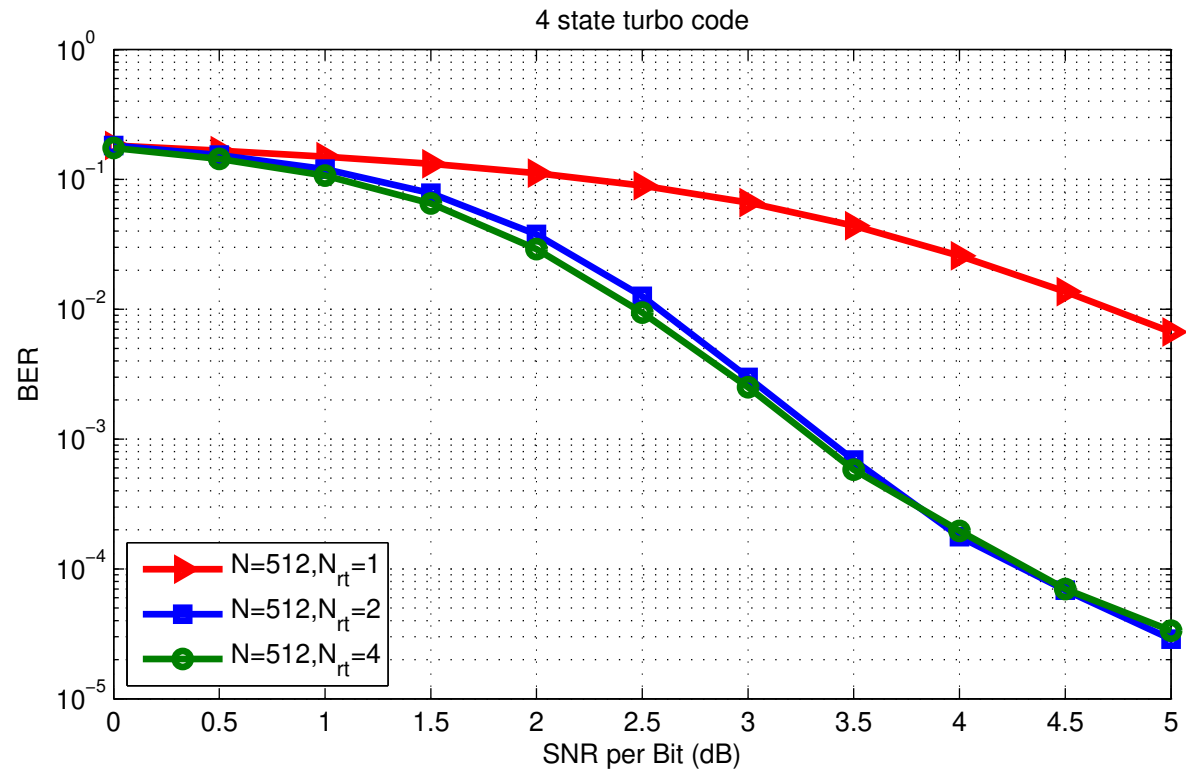

Figure 8: Results for 4-state turbo code,  $N = 512$ .



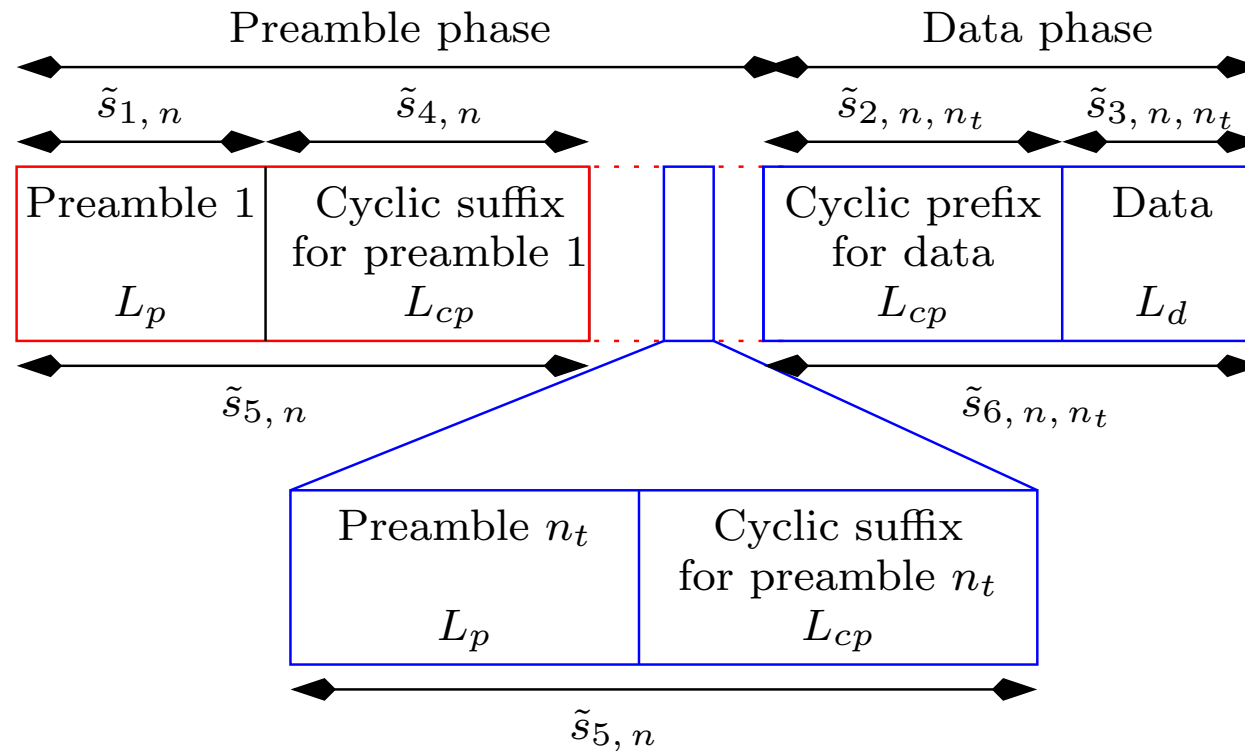

Figure 9: Frame structure for coherent massive MIMO.

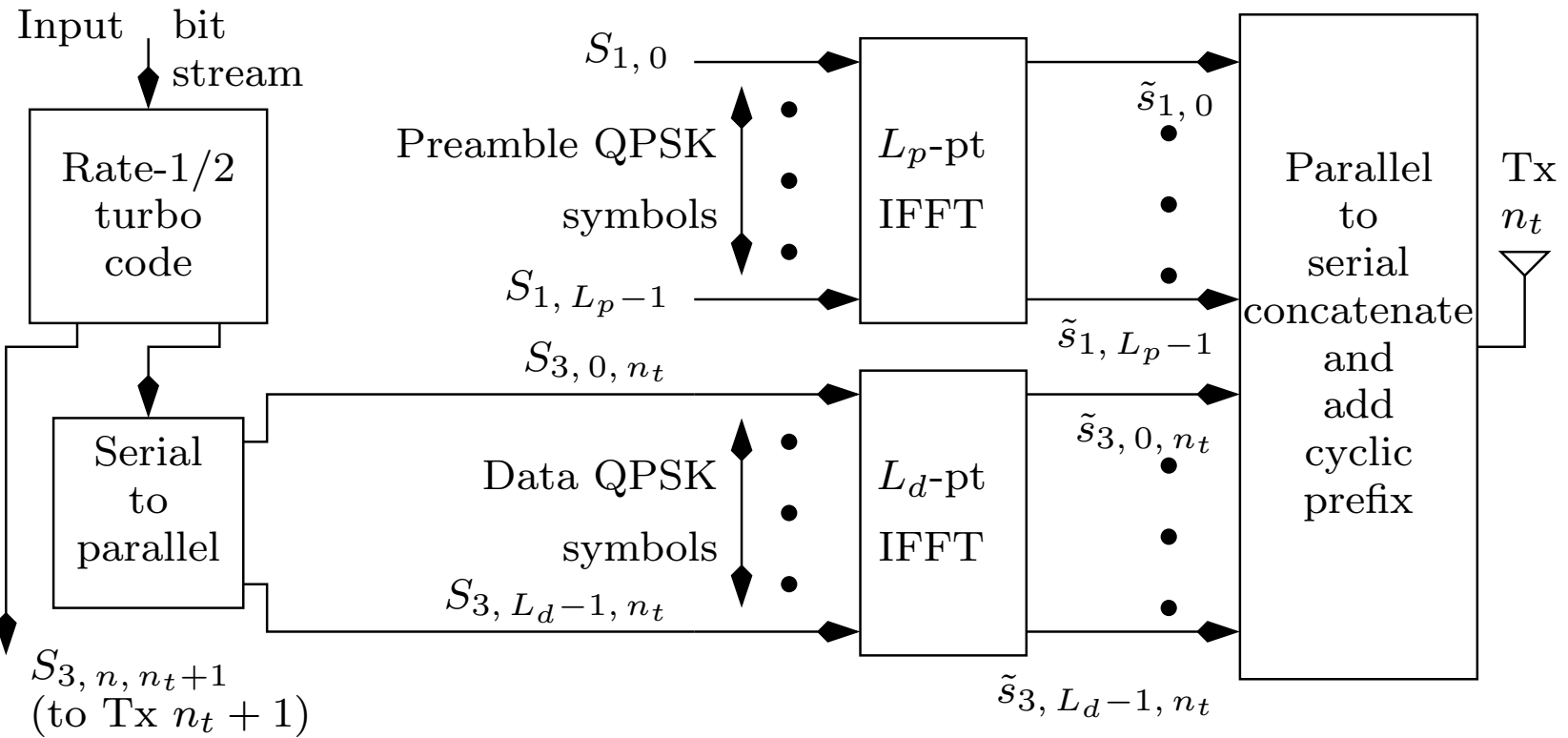

Figure 10: Tx  $n_t$  for coherent massive MIMO.

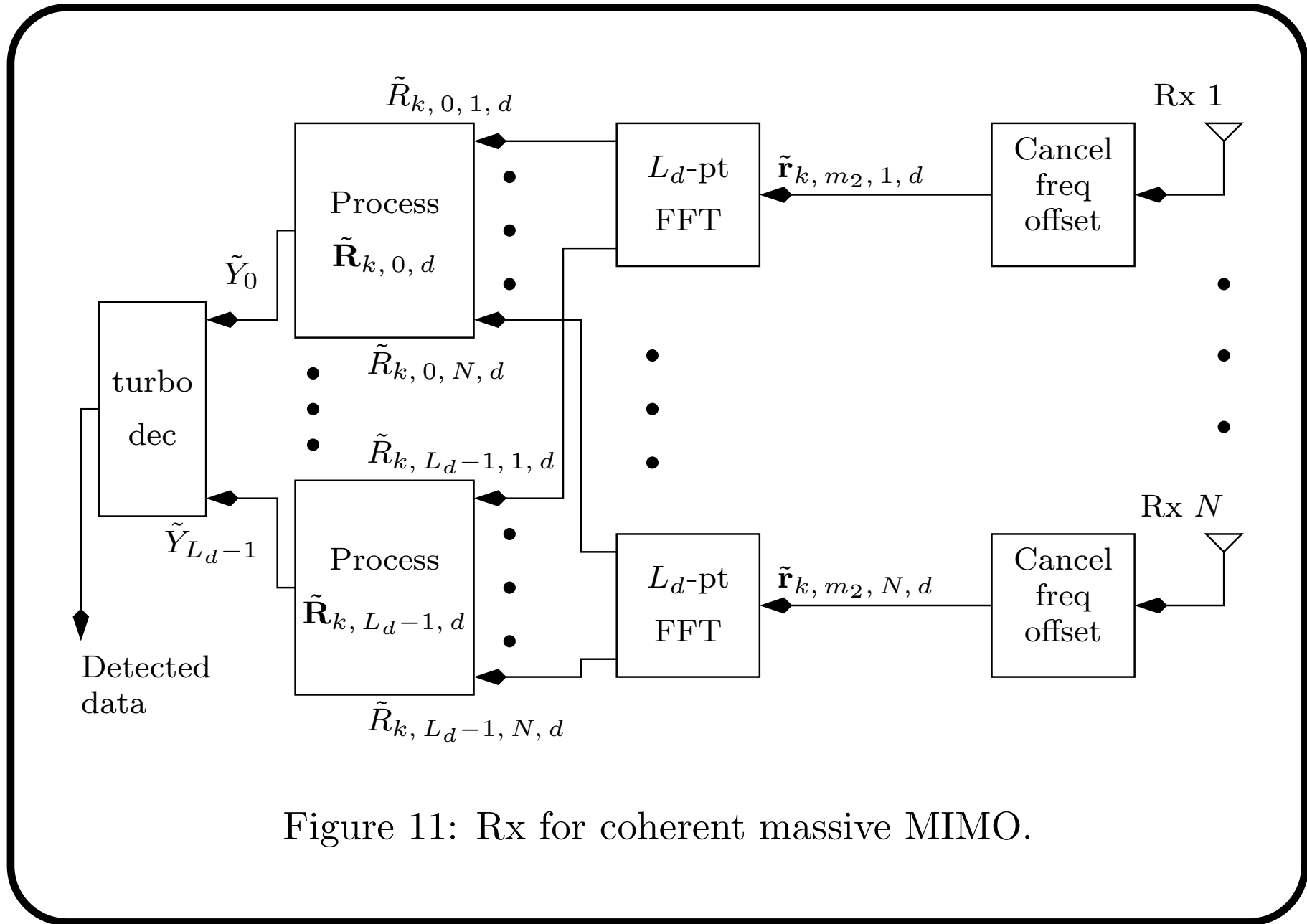
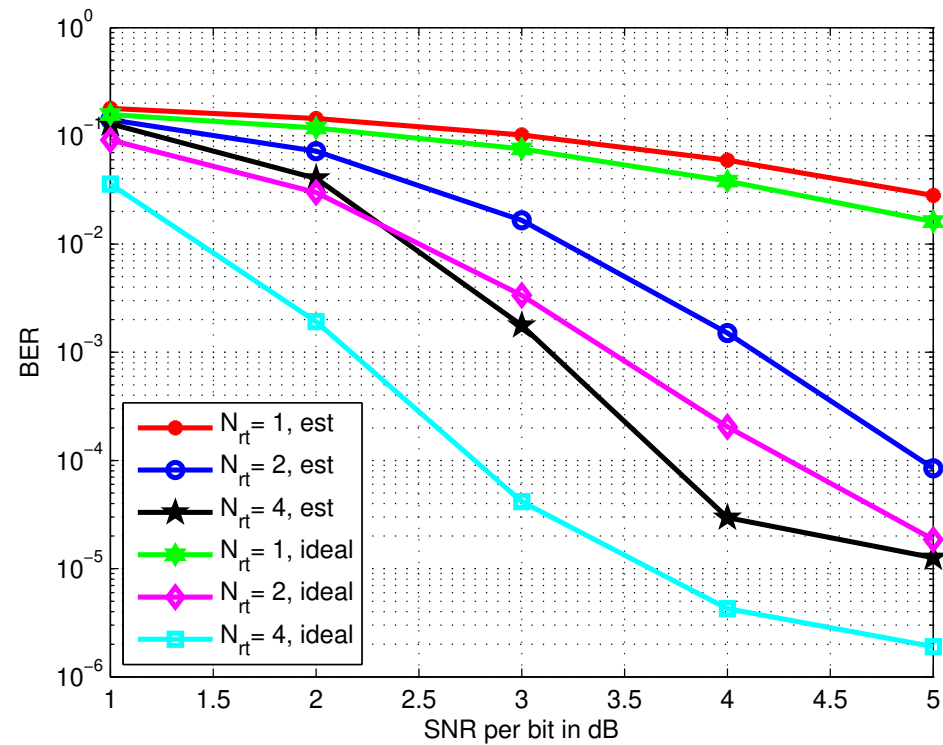
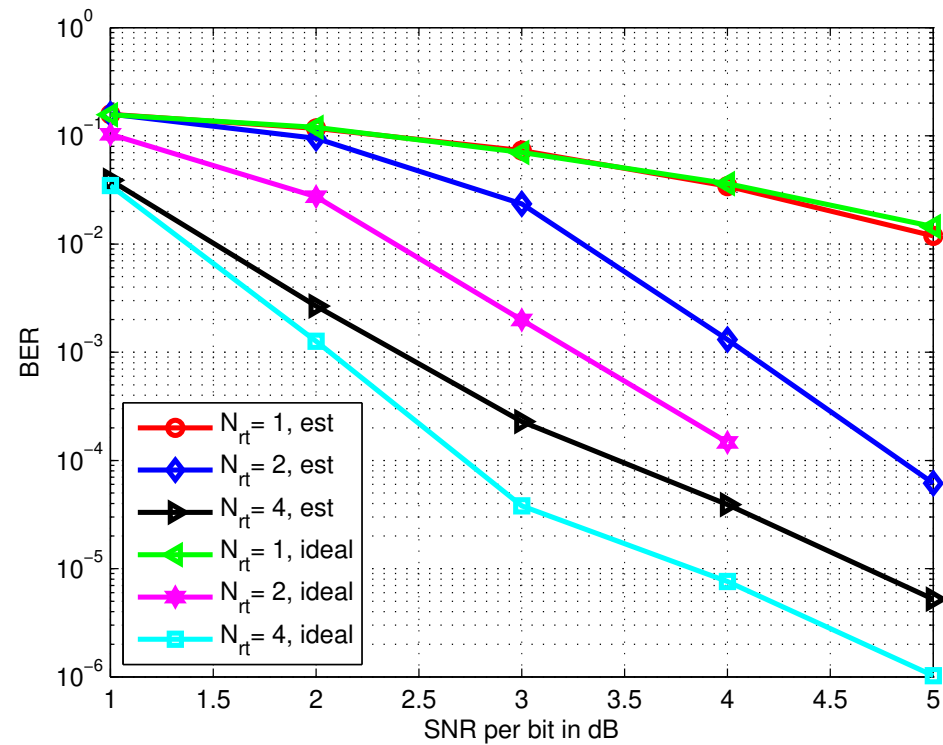

Figure 11: Rx for coherent massive MIMO.

Figure 12: Results for  $4 \times 4$  coherent MIMO.

Figure 13: Results for  $8 \times 8$  coherent MIMO.

## Conclusions & Future Work

- Precoding
- Probability of erasure

## References

- K. Vasudevan, K. Madhu, Shivani Singh, “Data Detection in Single User Massive MIMO Using Re-Transmissions”, *The Open Signal Processing Journal*, vol. 6, pp. 15–26, March 2019. Also available at: <https://arxiv.org/abs/1811.11369>
- K. Vasudevan, Shivani Singh and A. Phani Kumar Reddy, “Coherent Receiver for Turbo Coded Single-User Massive MIMO-OFDM with Retransmissions”, *IntechOpen*, April 2019. Available at: <https://www.intechopen.com/books/multiplexing/coherent-receiver-for-turbo-coded-single-user-massive-mimo-ofdm-with-retransmissions>