

Lecture 5

ORTHOGRAPHIC PROJECTIONS :: LINE WORK & BASICS



TA 101 : Engineering Graphics

2007-08 Semester II

January – May 2008

OUTLINE

- Line styles
- Making the orthographic views



LINE STYLES

- Lines drawn
 - Boundaries of object
 - Meeting of surfaces of object

- Five types of line styles used

- Visible lines



- Hidden lines



- Centerlines



- Dimension lines



- Construction lines



- Visible & Hidden lines
 - Boundaries

Orthographic View

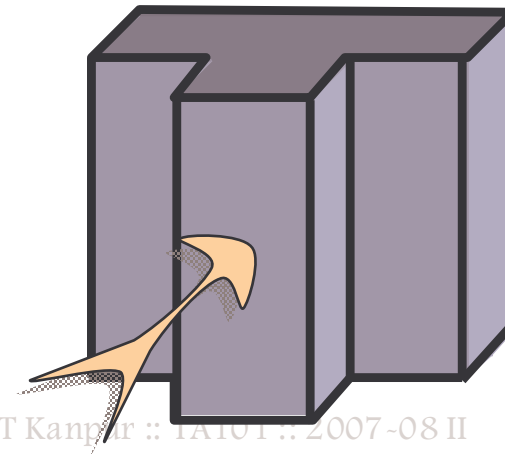
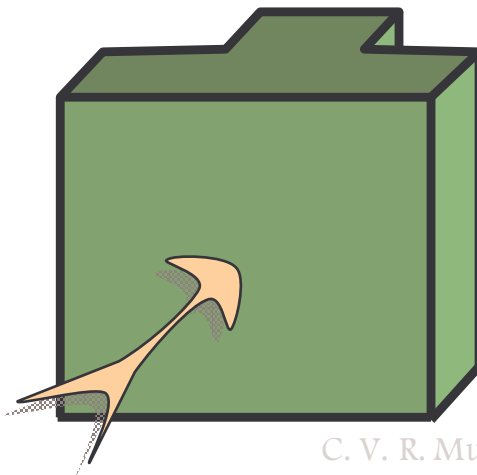
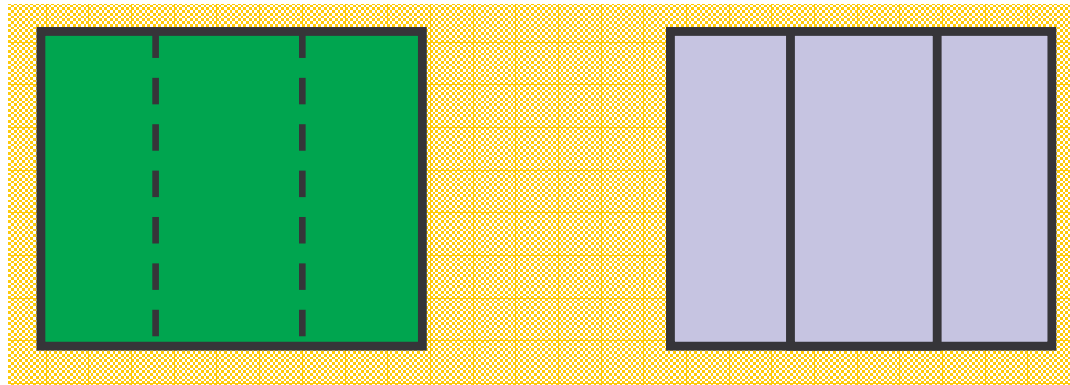

- Visible & Hidden lines

- Boundaries

Orthographic View

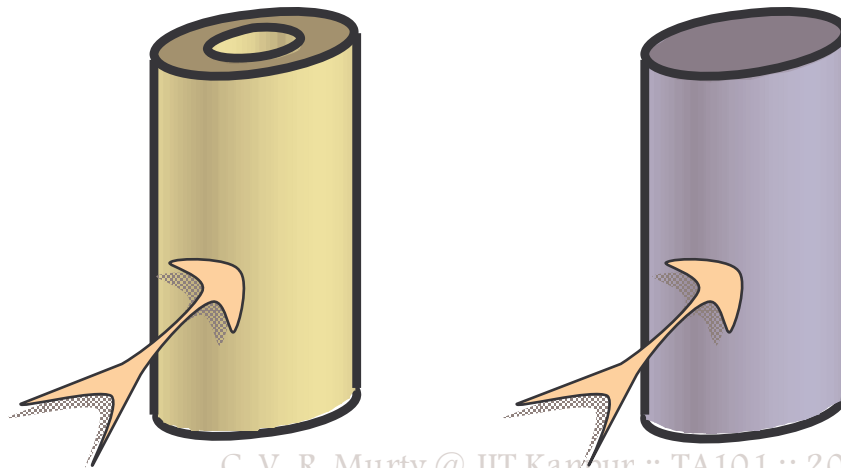
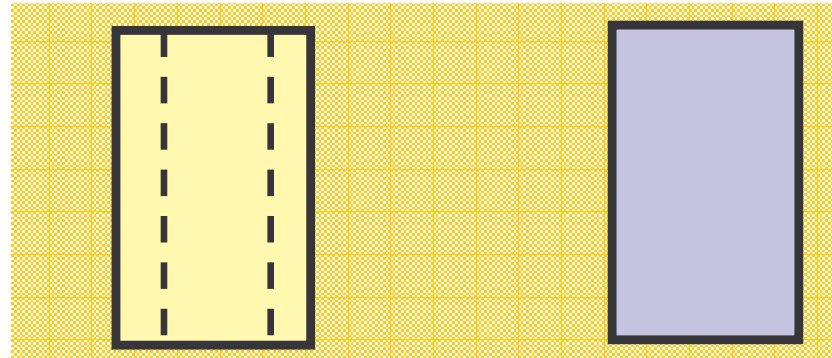

LINES

- Visible & Hidden lines
 - Surfaces meet

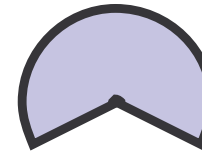

Orthographic View

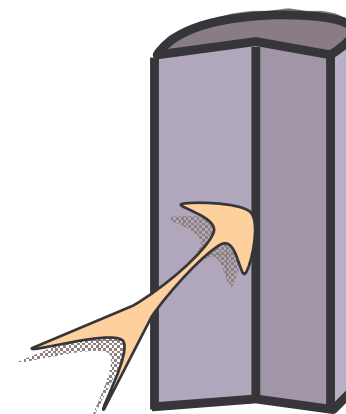
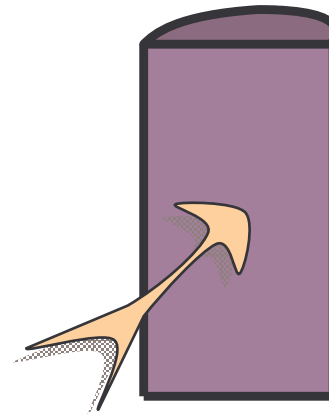
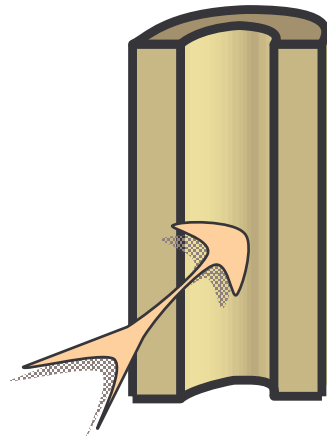
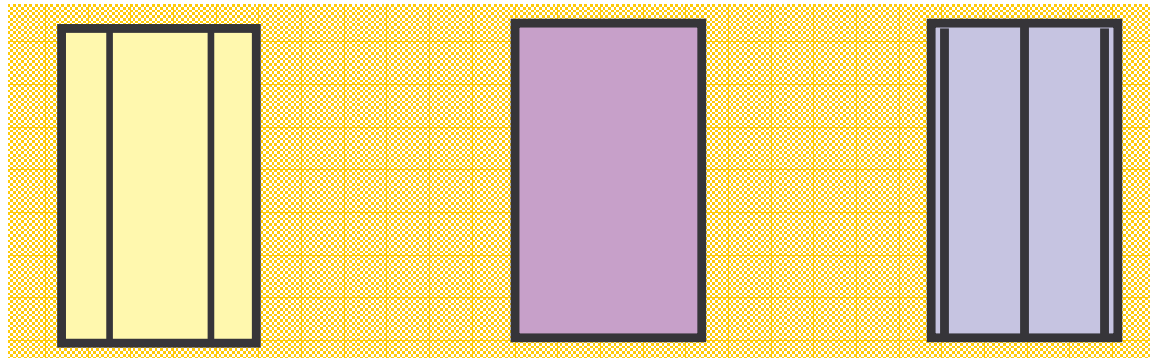

- Centerlines
 - Axial Symmetry

Orthographic View

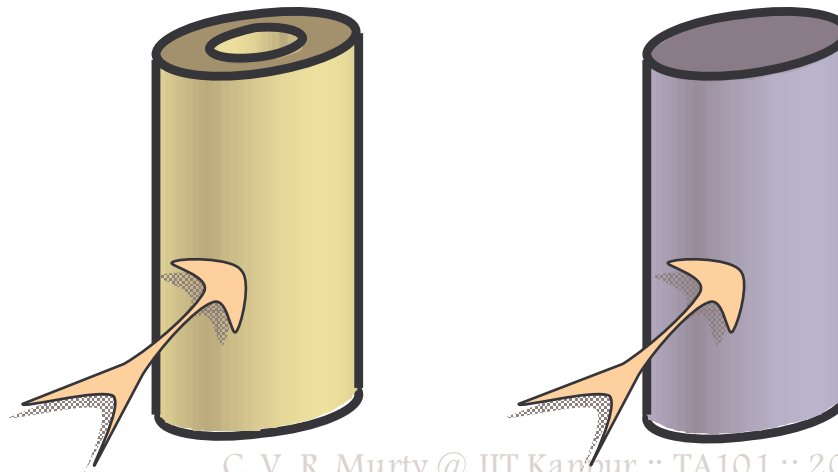
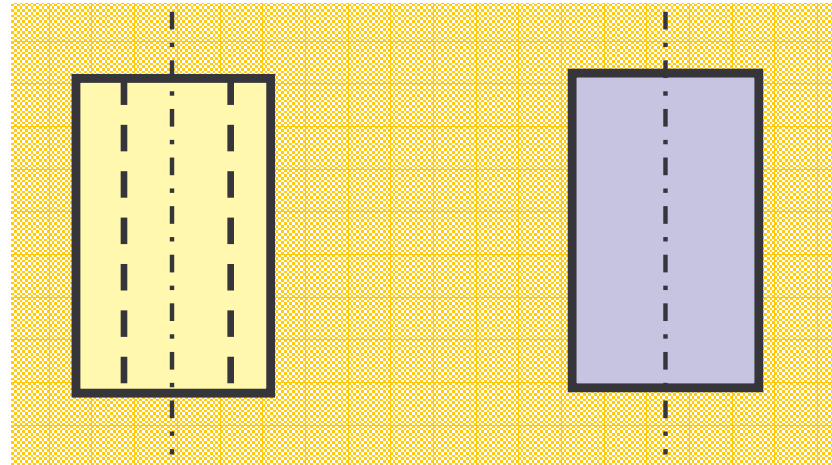

- Construction lines
 - Guide lines

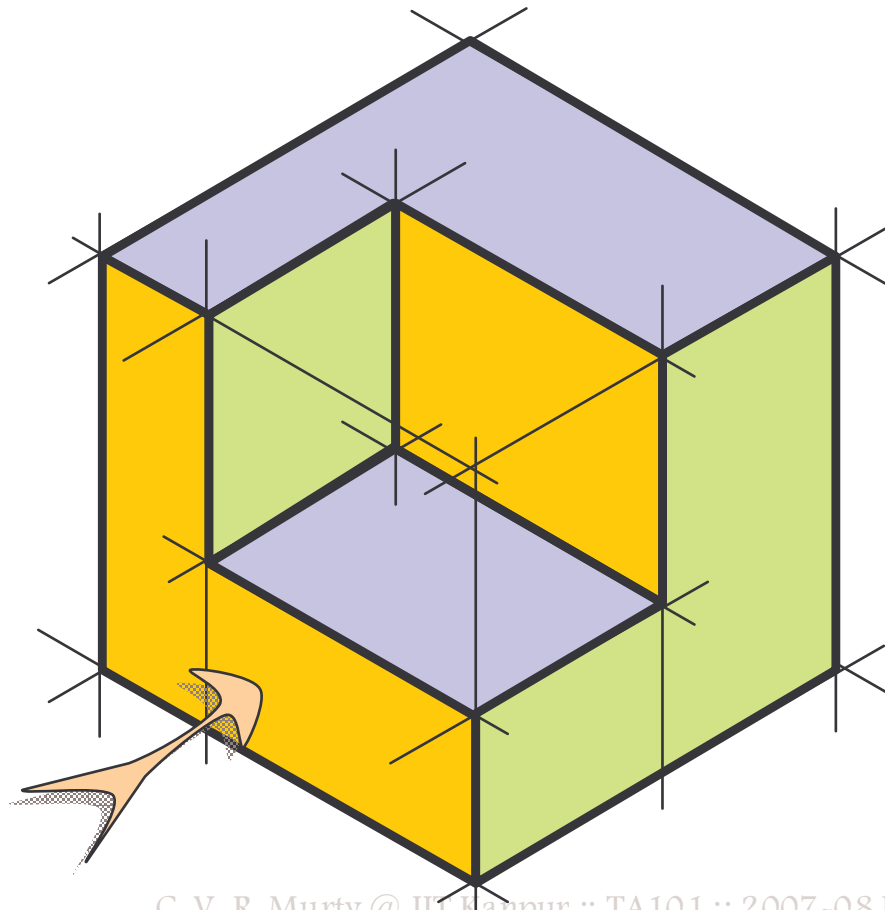

- Construction lines
 - Guide lines

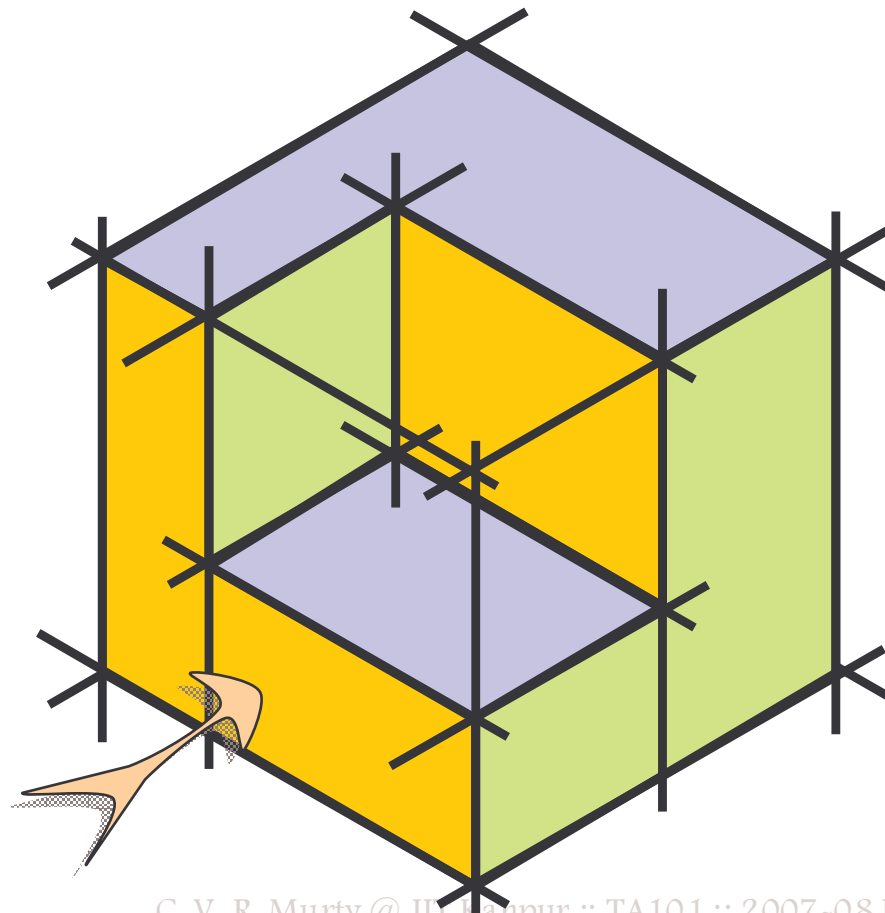

- Construction lines
 - Curved & straight

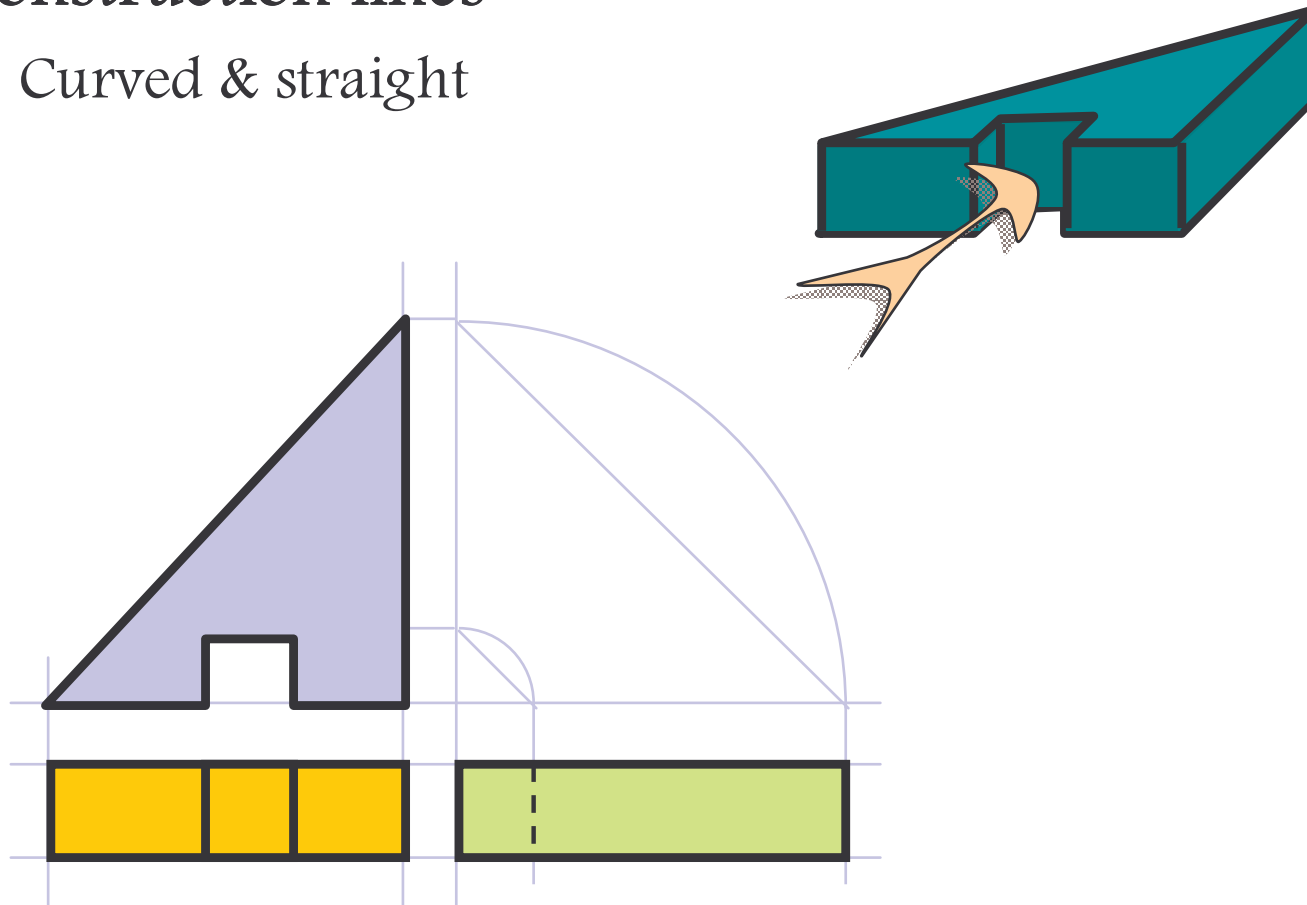

- Construction lines
 - Curved & straight

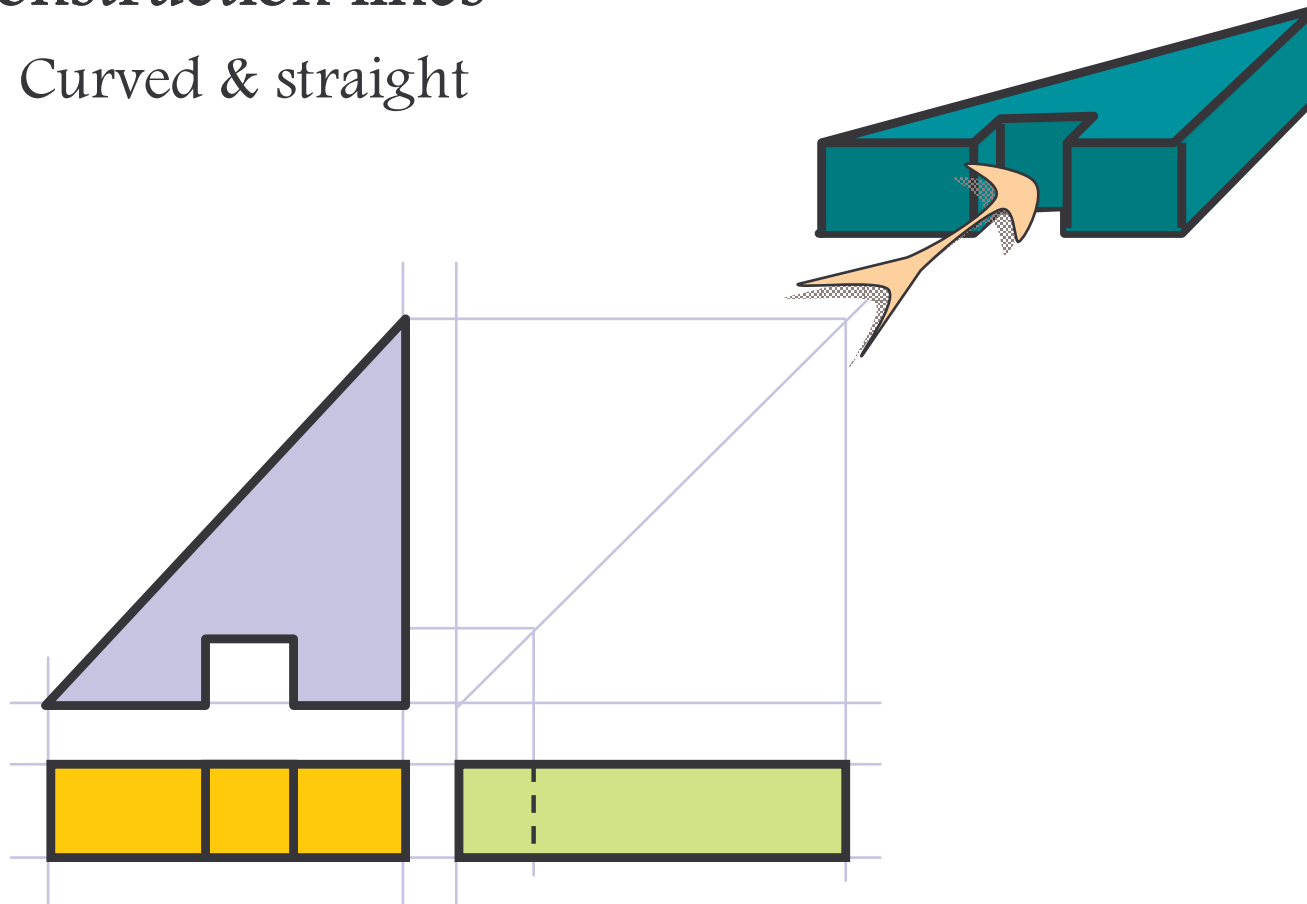

- Visible & Hidden lines
 - Dimension lines

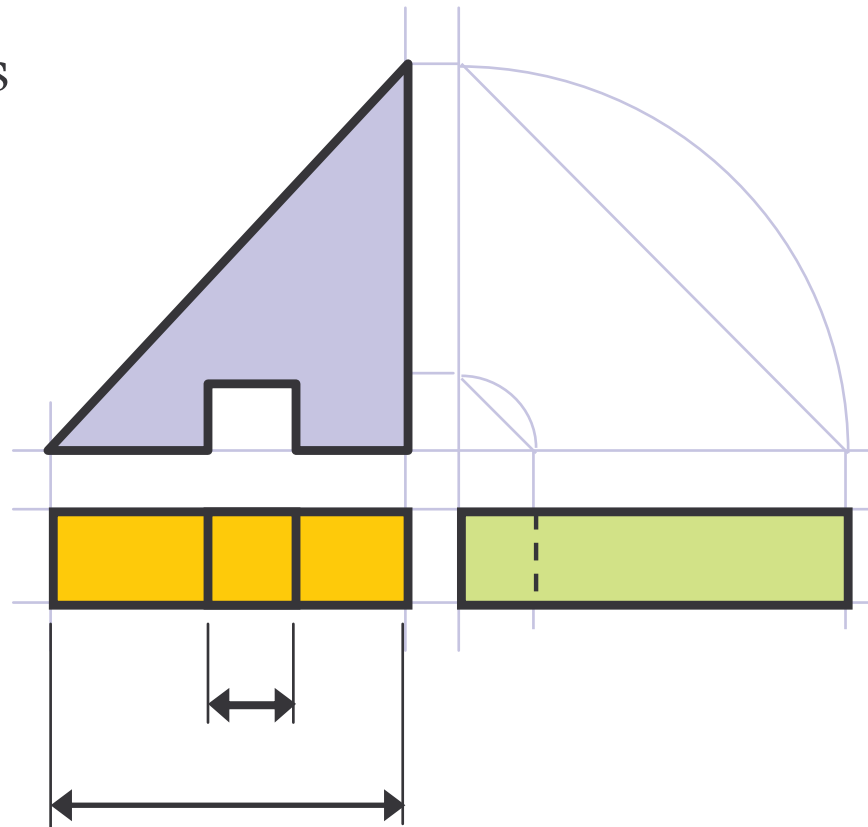

MAKING THE
ORTHOGRAPHIC
VIEWS

PROJECTING PLANES

- Viewing faces

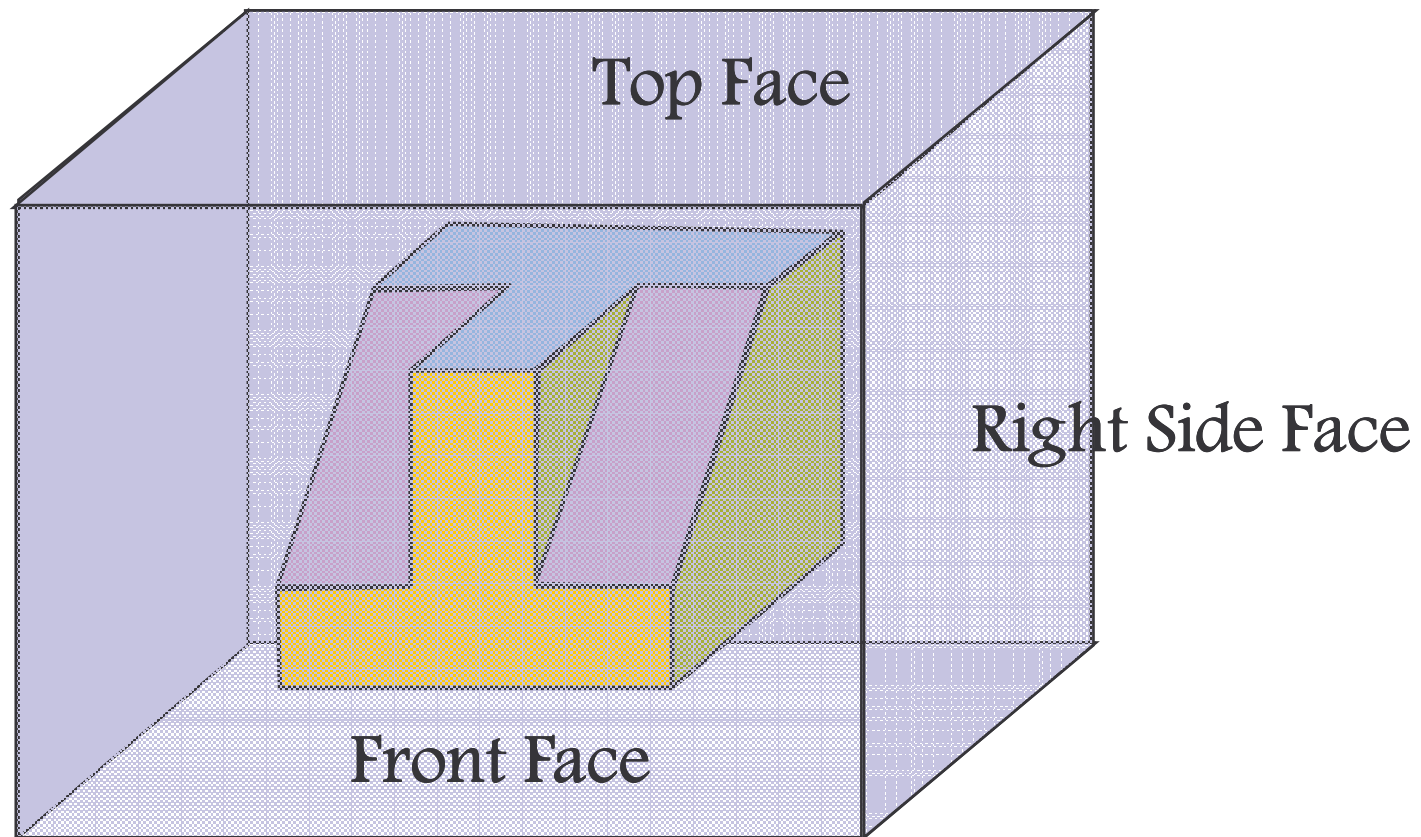

PROJECTING PLANES

- Relative positioning

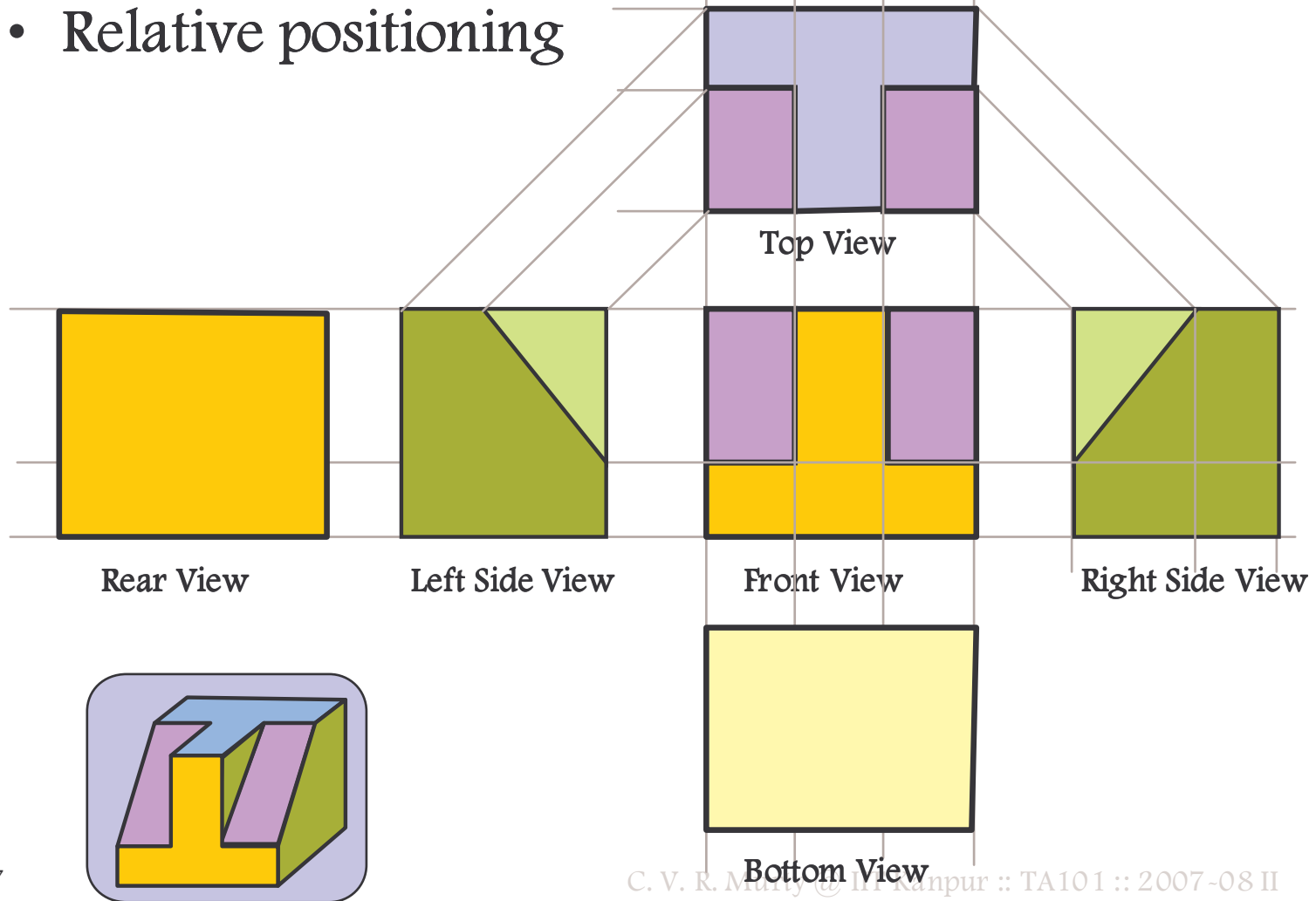

PROJECTING PLANES

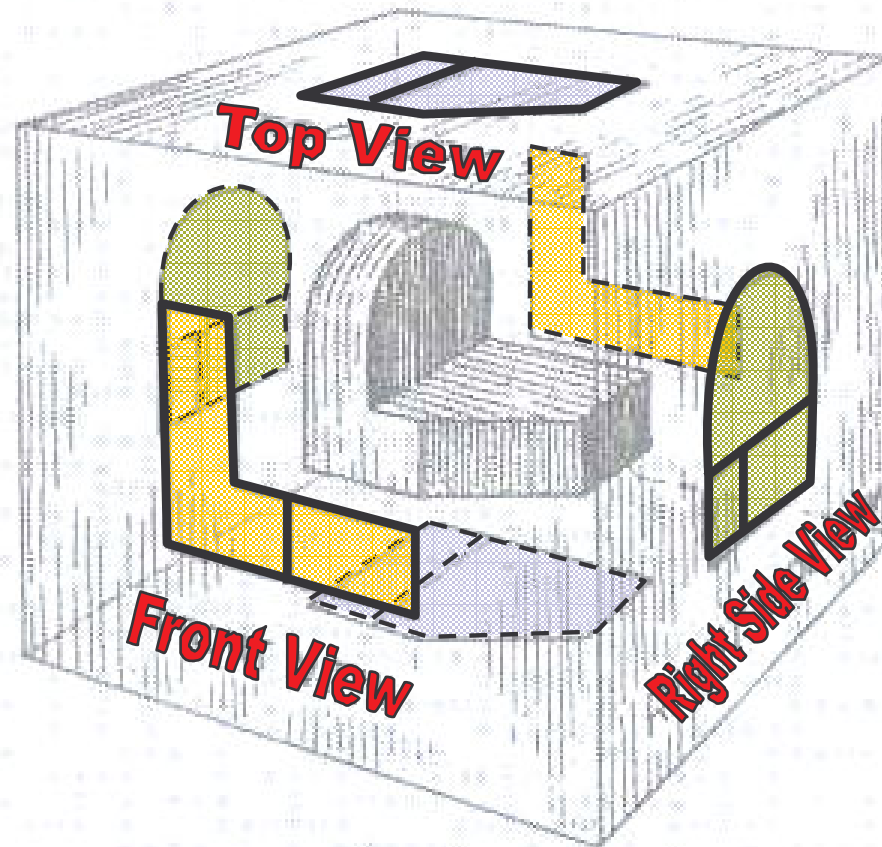

PROJECTING PLANES

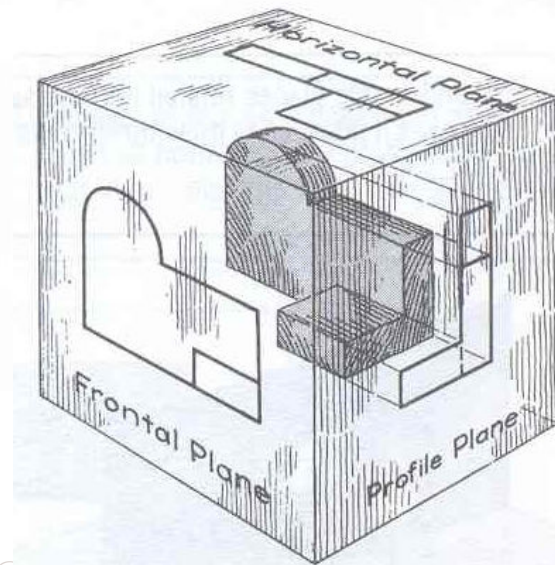
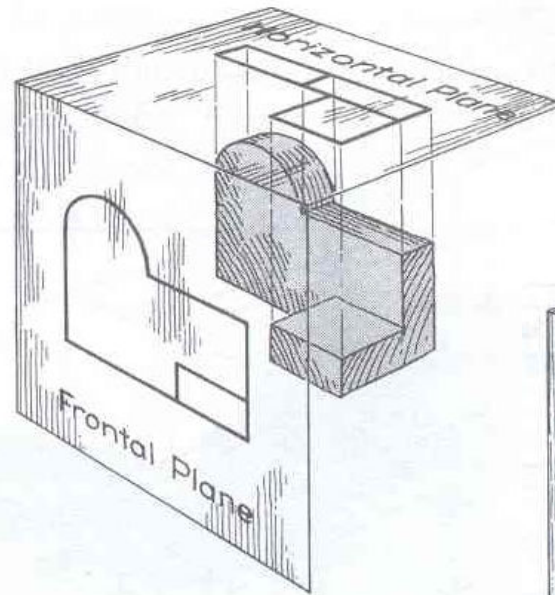
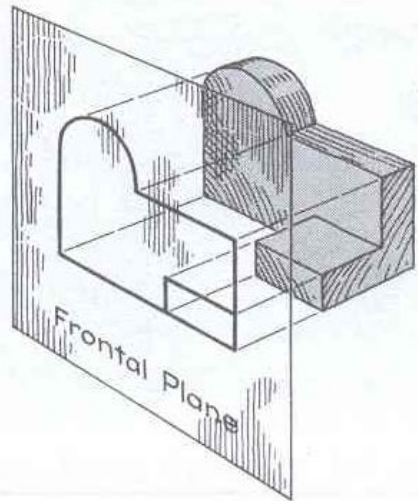

PROJECTING PLANES

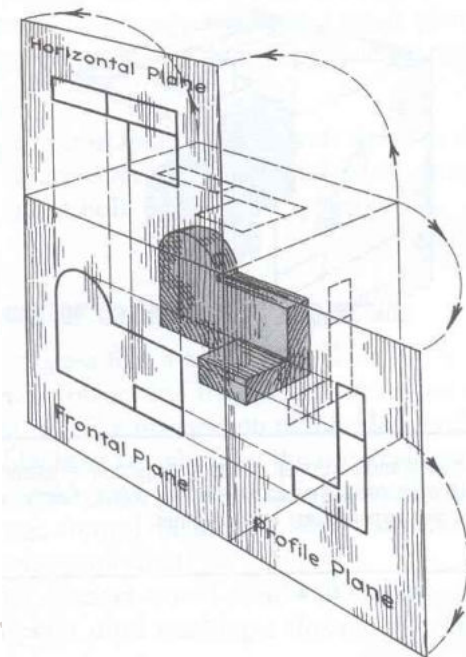
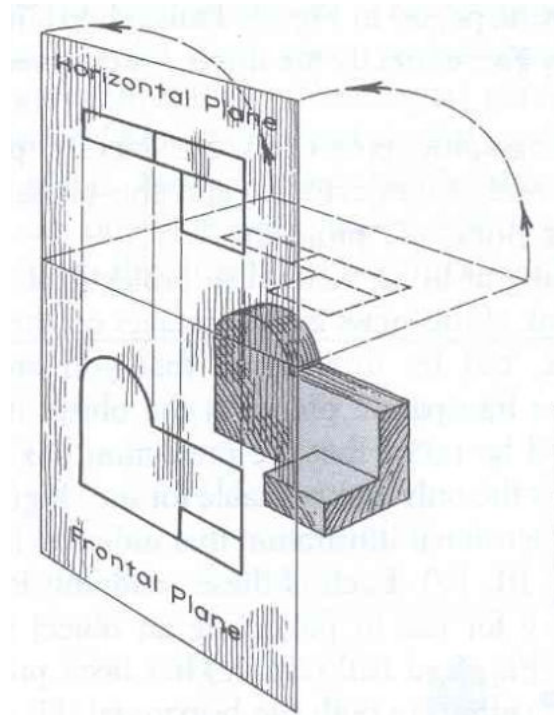
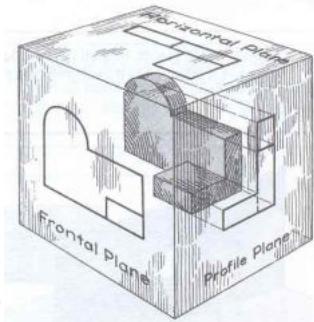
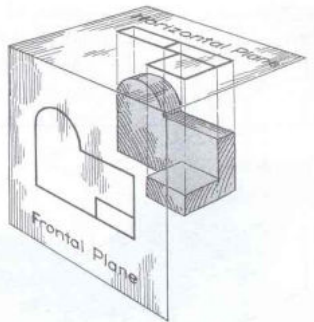
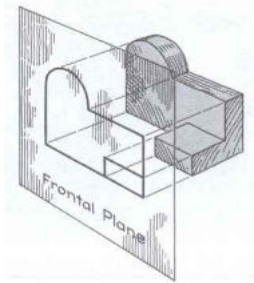

PROJECTING PLANES

- Projecting Planes

Horizontal Plane

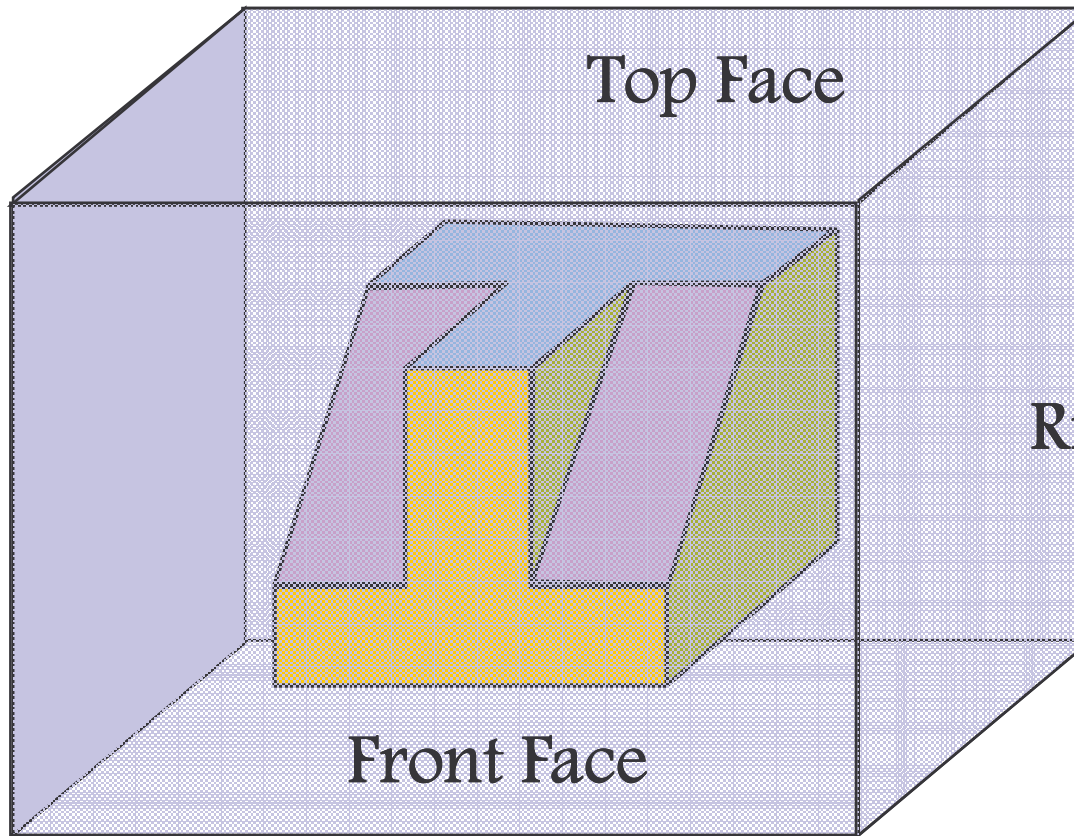

Right Side Face

Profile Plane

Front Face

Vertical Plane

PROJECTING PLANES

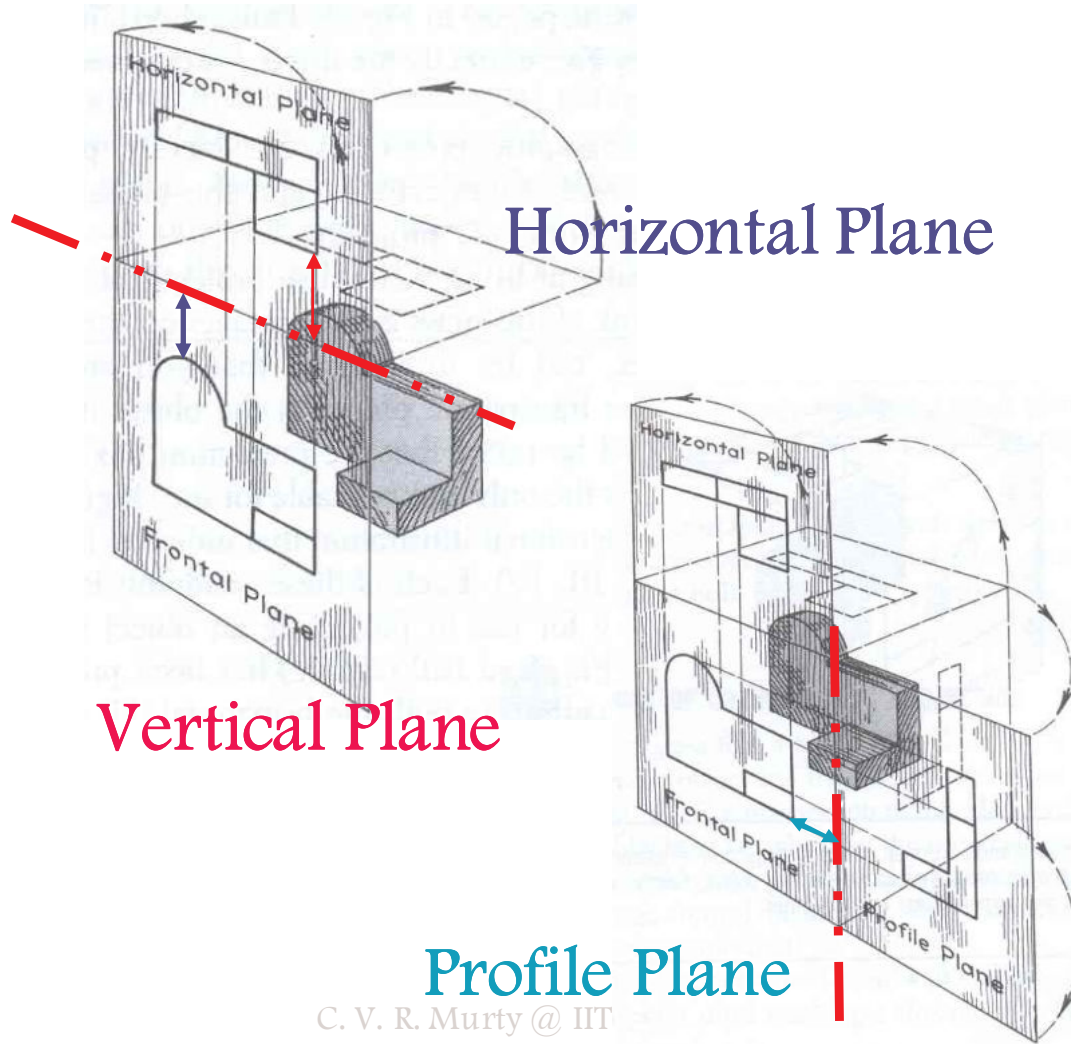
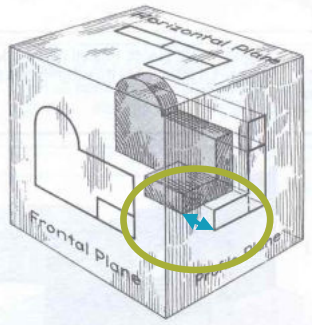
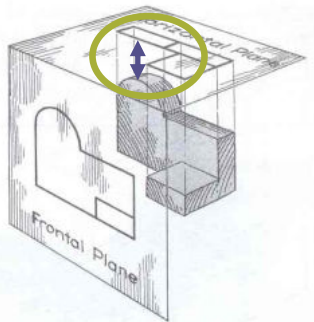
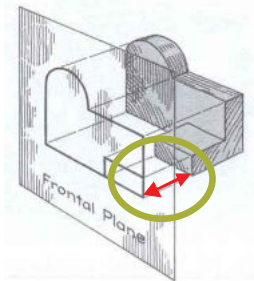

SIMPLE OBJECTS

- Truncated Cube

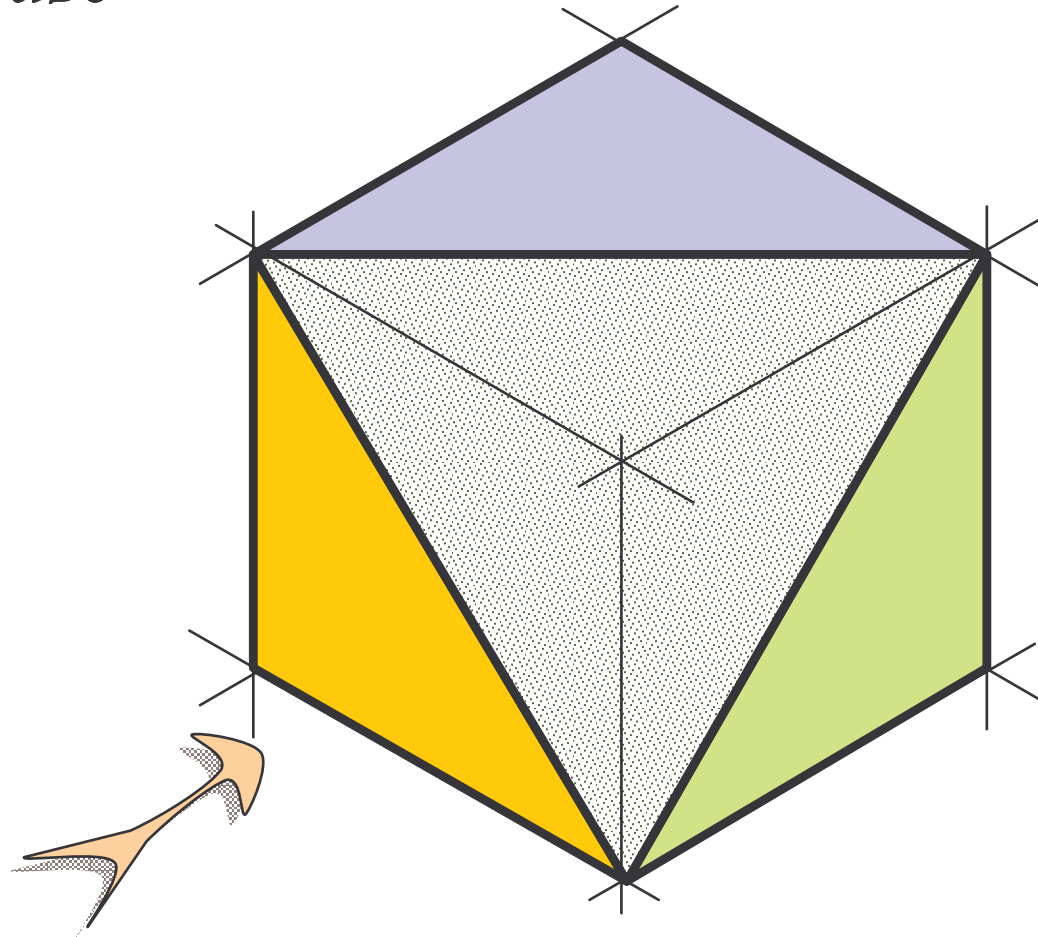

SIMPLE OBJECTS

- Truncated Cube...

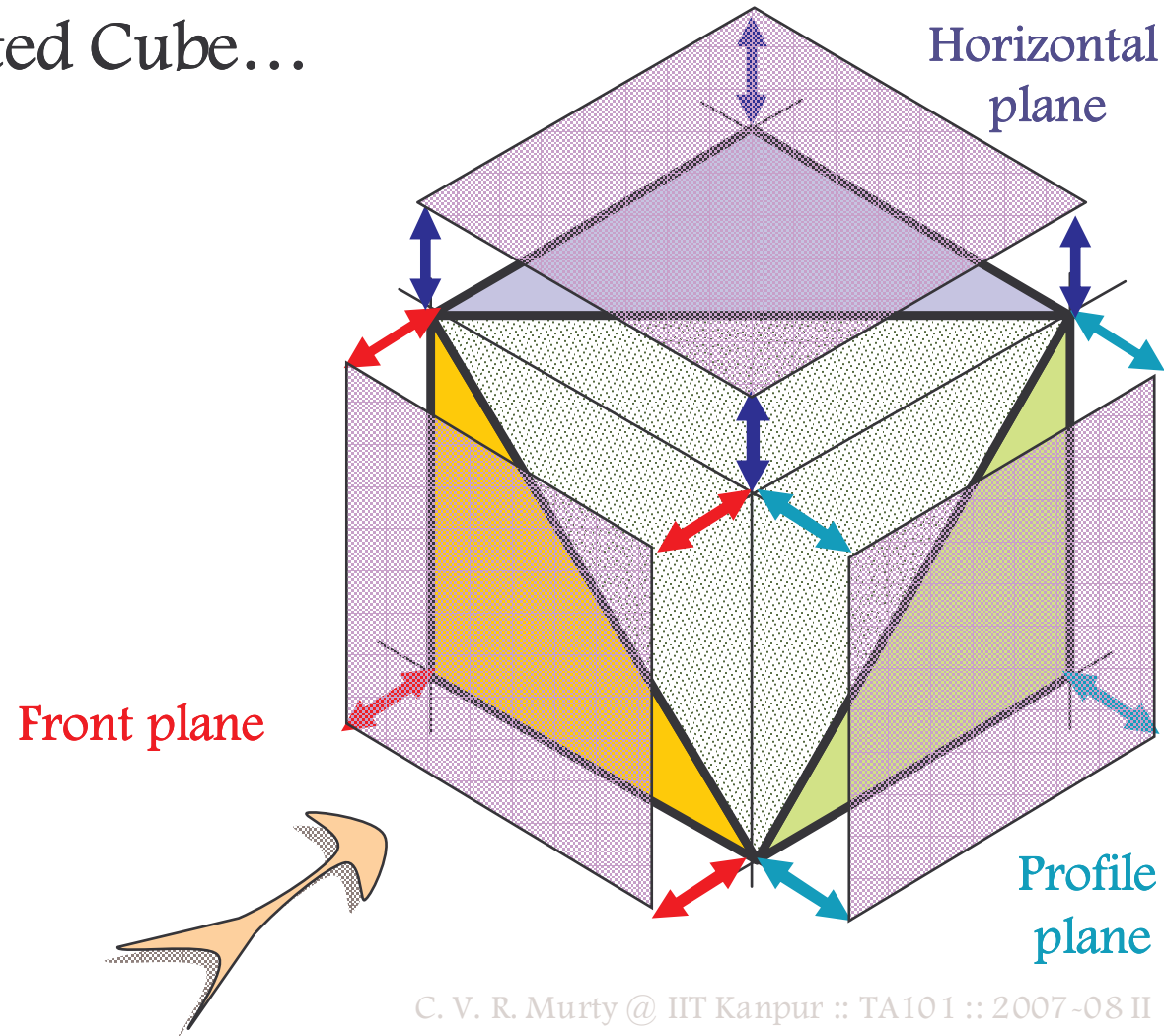

SIMPLE OBJECTS

- Truncated Cube...

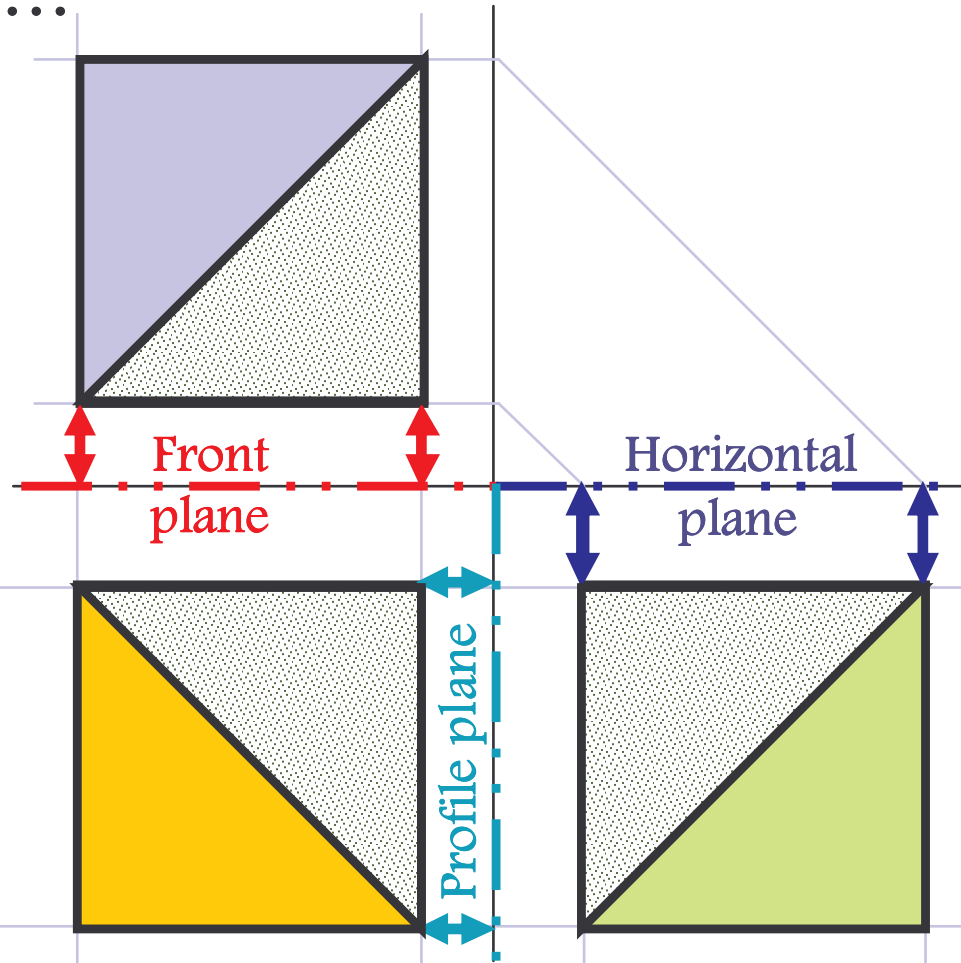
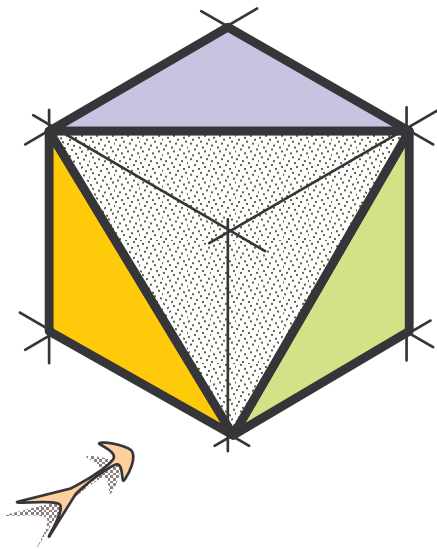

SIMPLE OBJECTS

- Sliced Cube

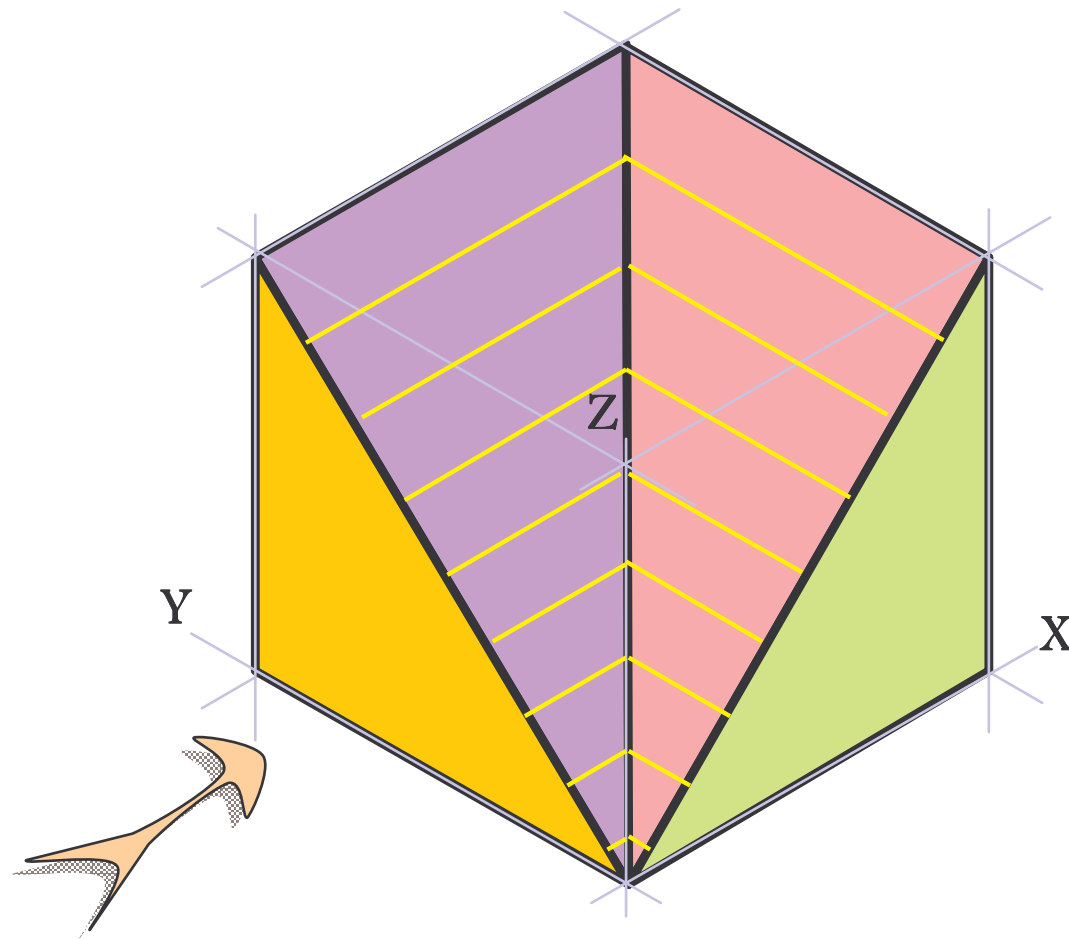

SIMPLE OBJECTS

- Sliced Cube...

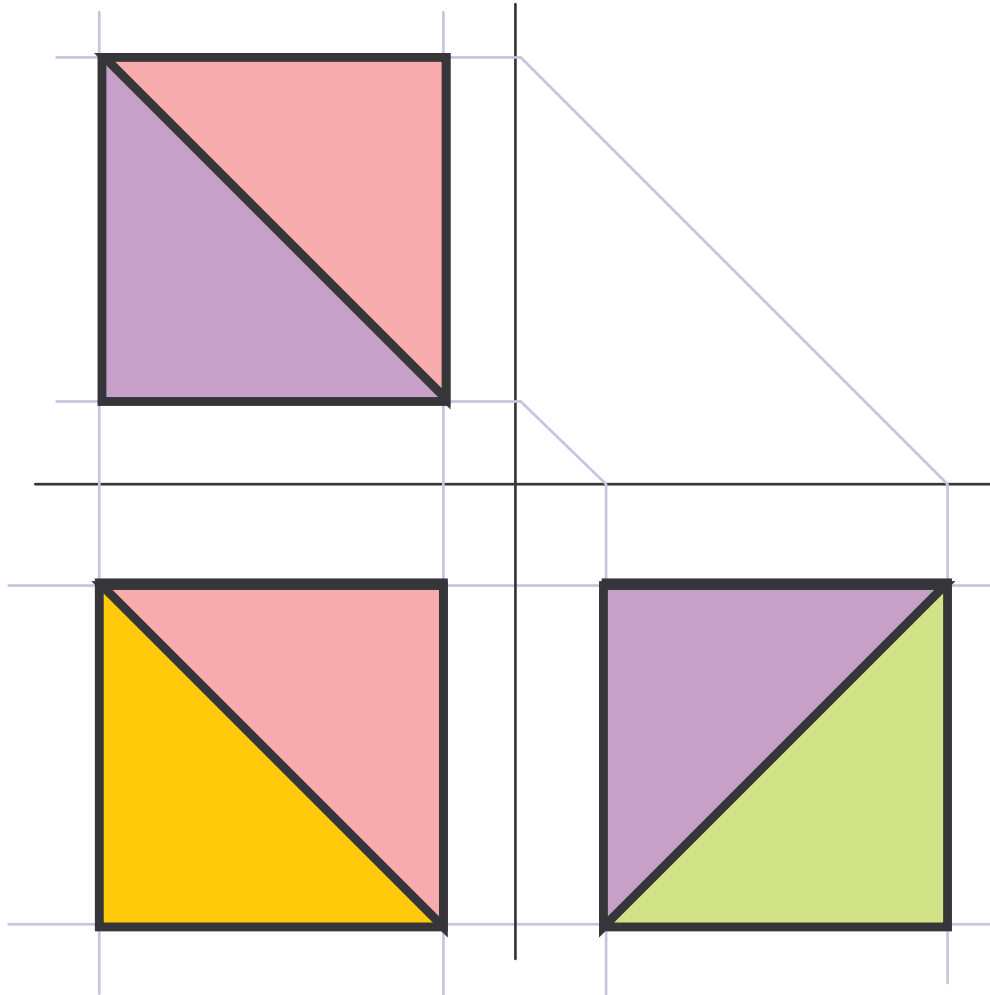
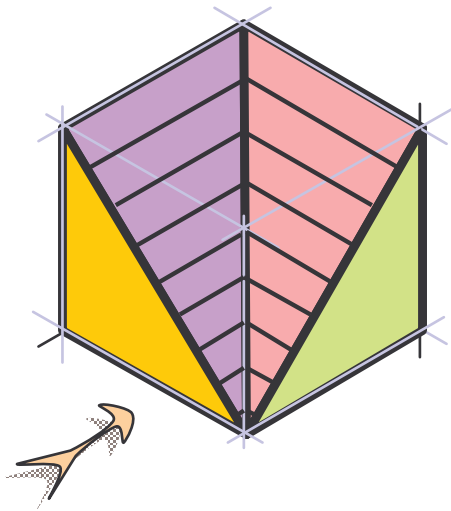

SIMPLE OBJECTS

- Guided ramp

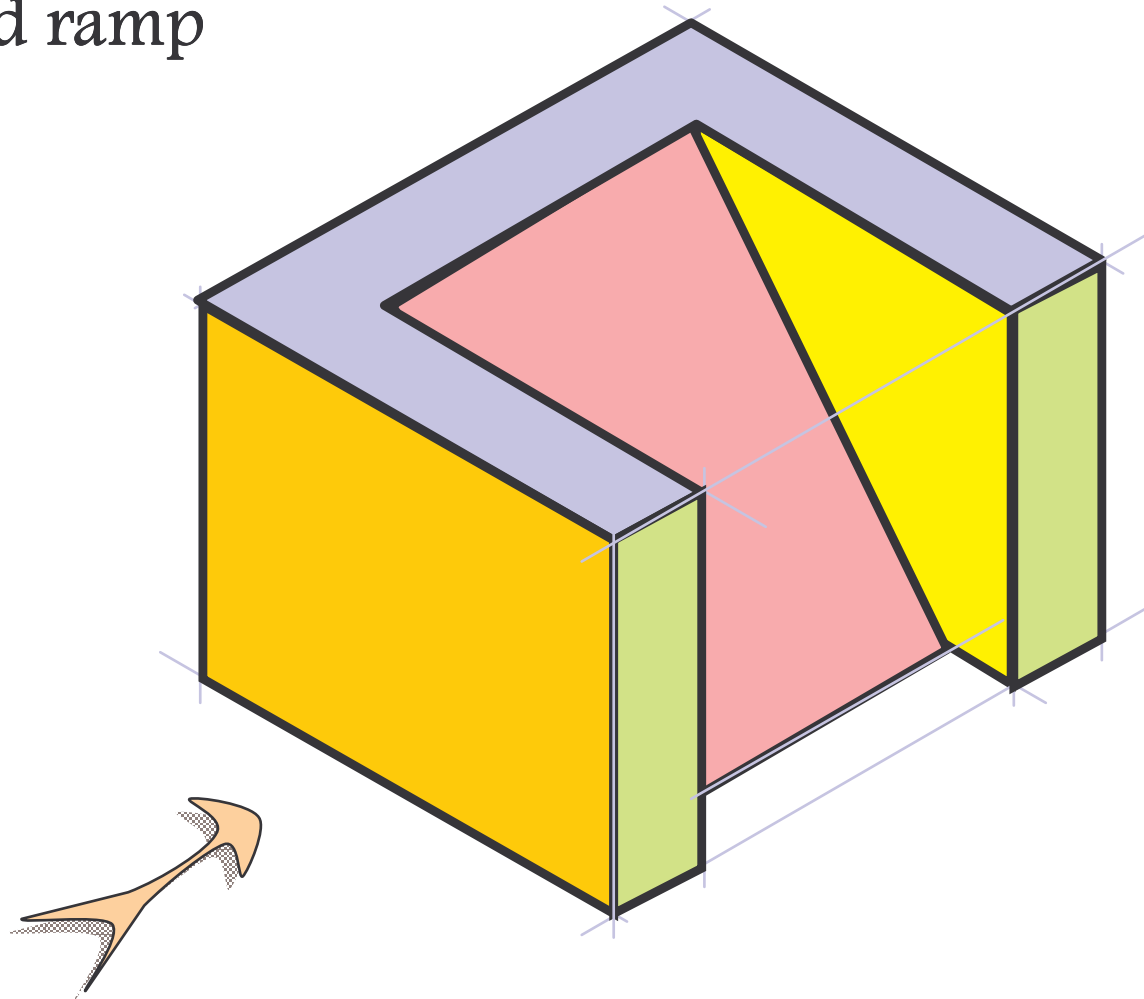

SIMPLE OBJECTS

- Guided ramp...

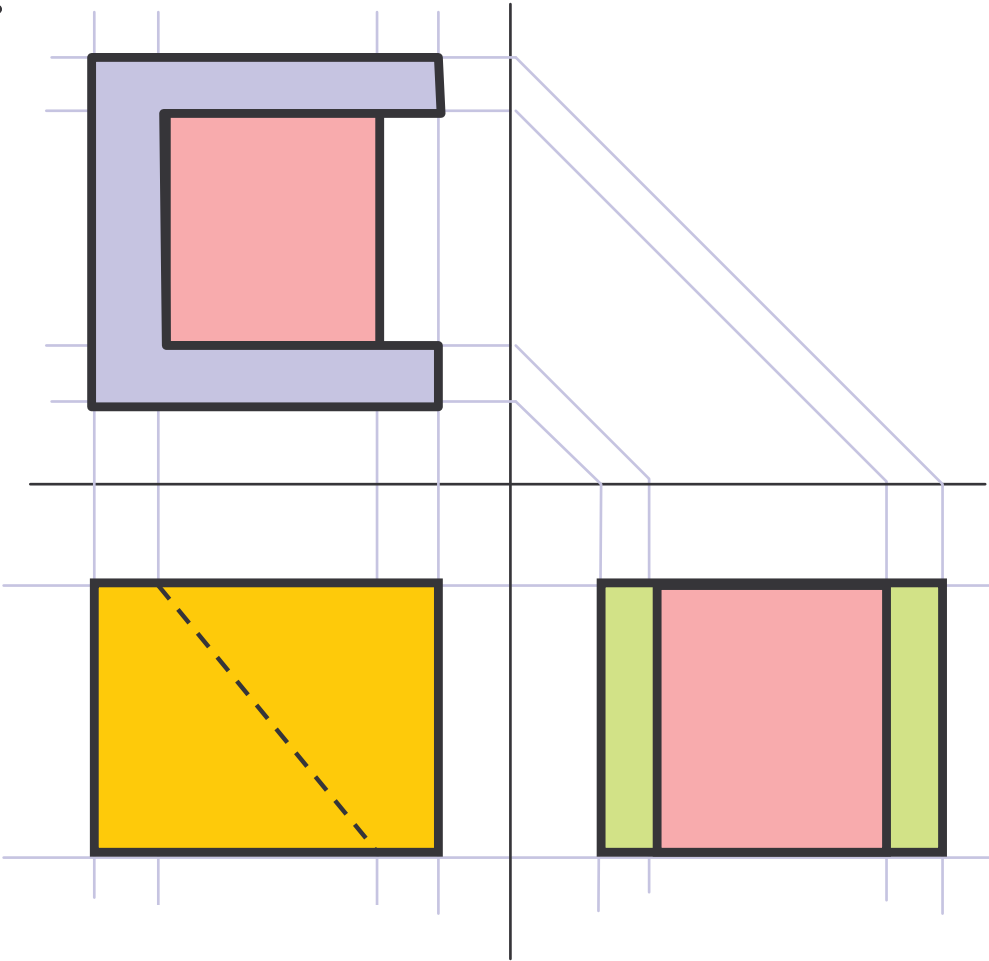
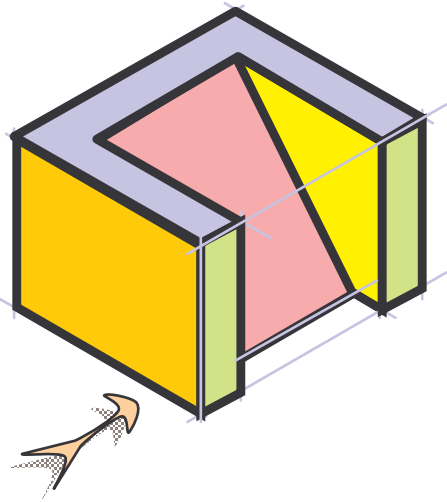

SIMPLE OBJECTS

- Guided ramp
 - Different direction of viewing

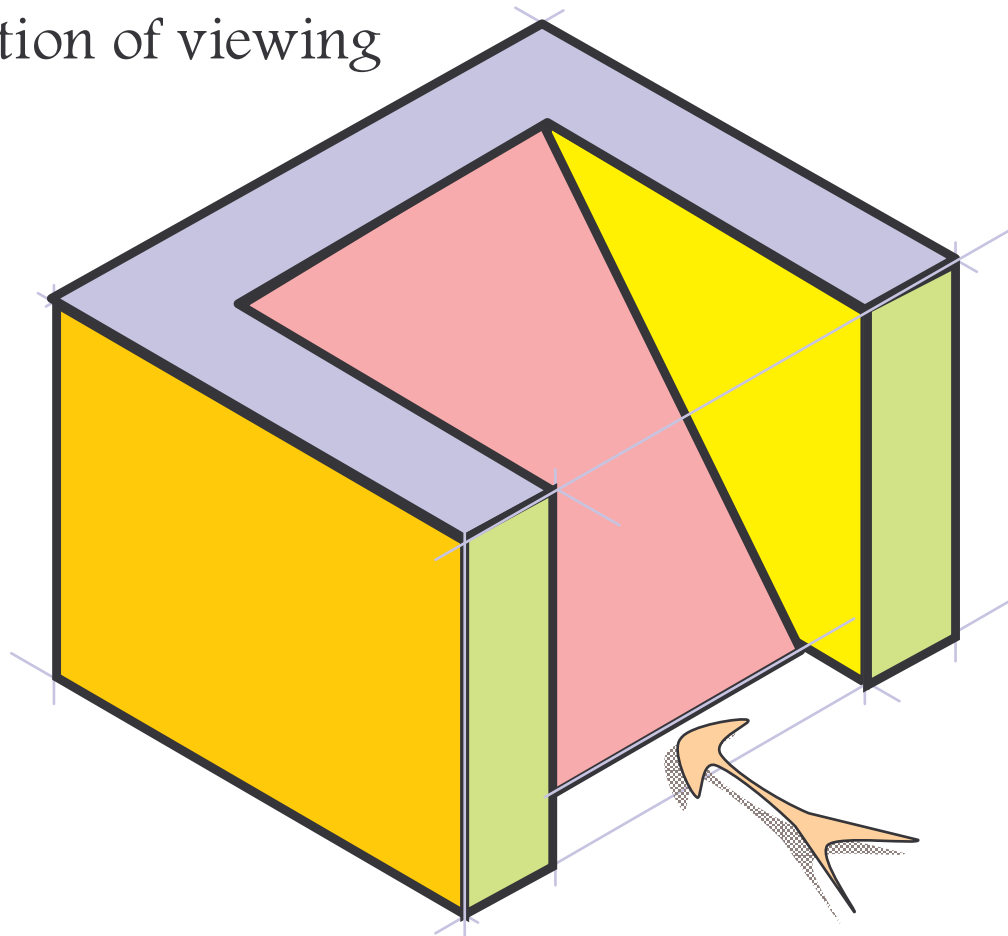

SIMPLE OBJECTS

- Guided ramp...
 - Different direction of viewing

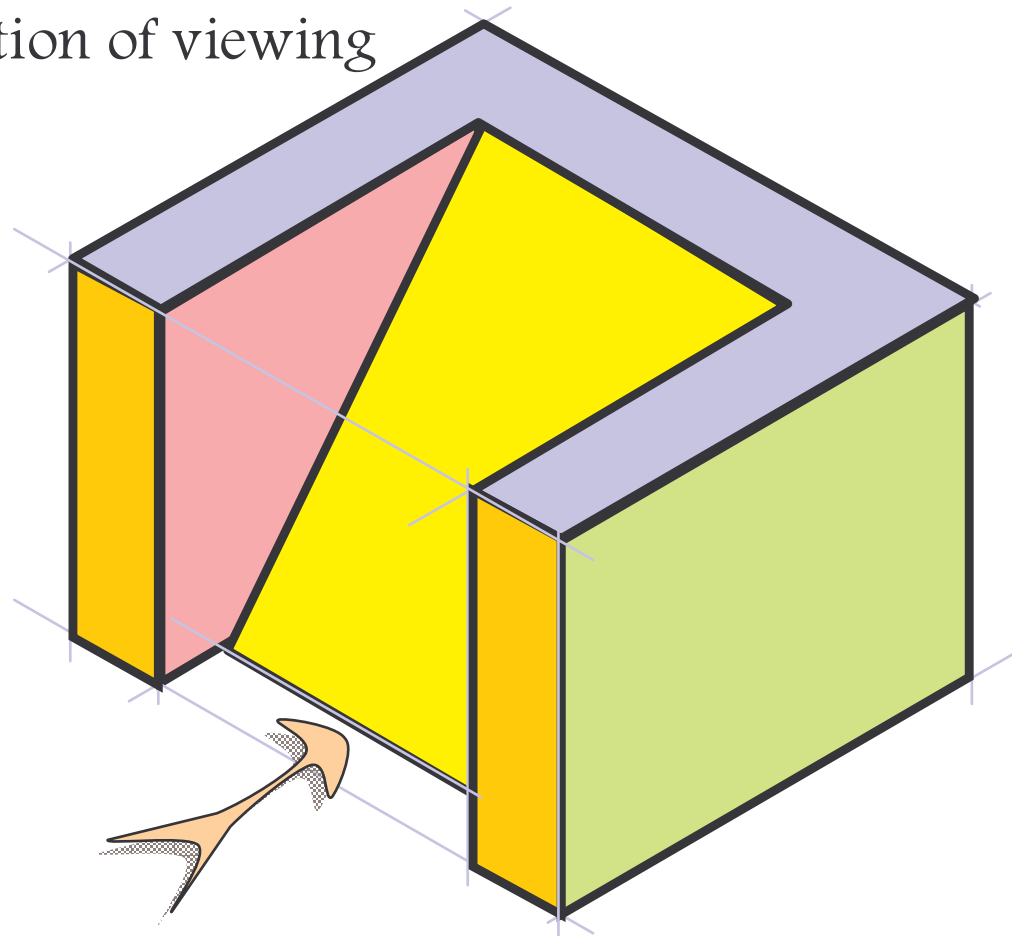

SIMPLE OBJECTS

- Guided ramp...

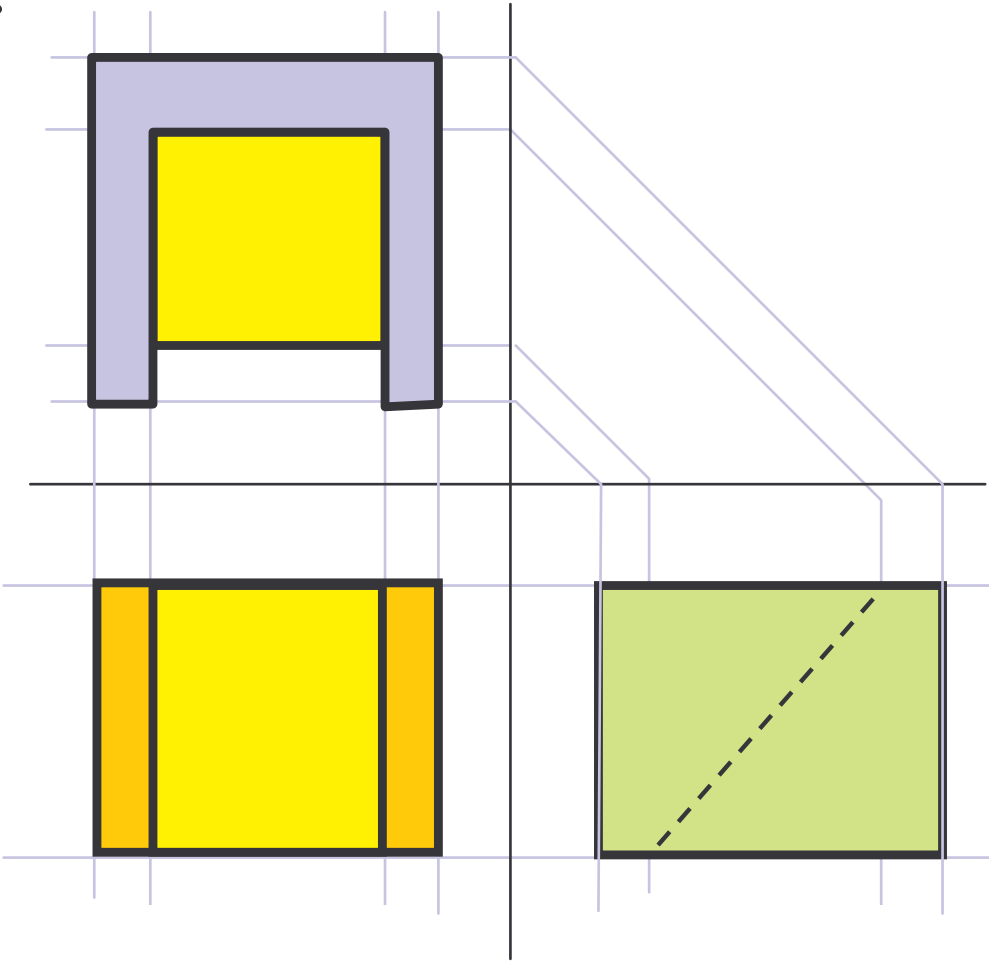
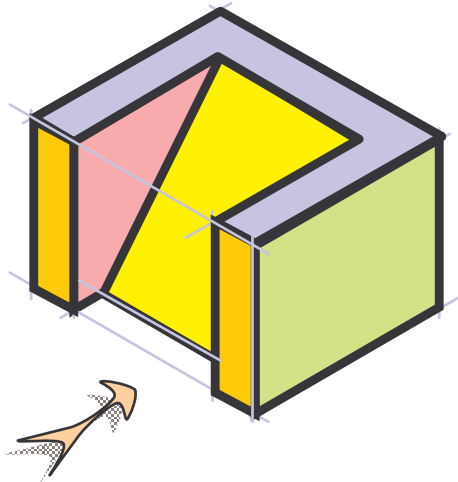

SIMPLE OBJECTS

- Bracket with high lip

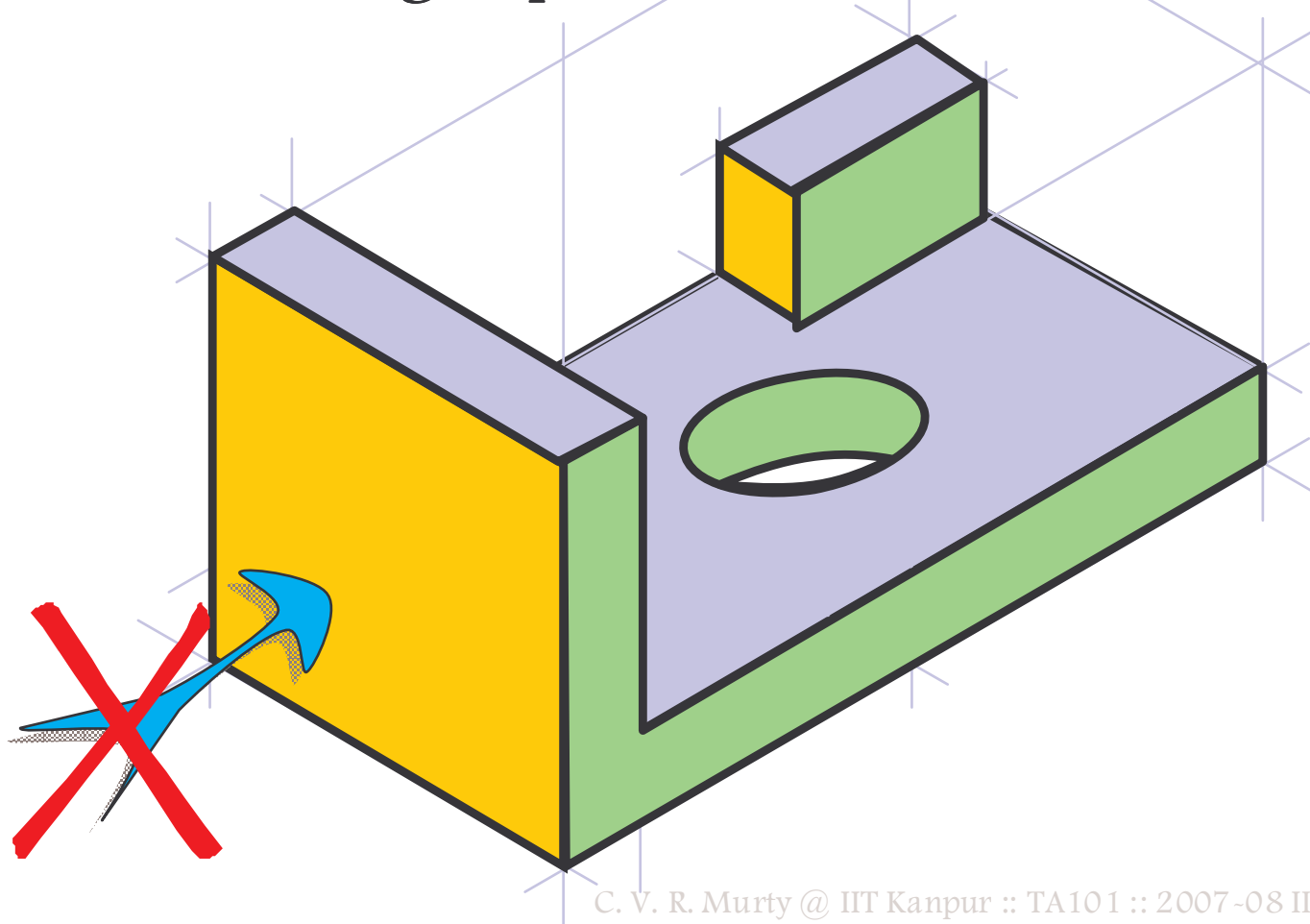

SIMPLE OBJECTS

- Bracket with high lip...

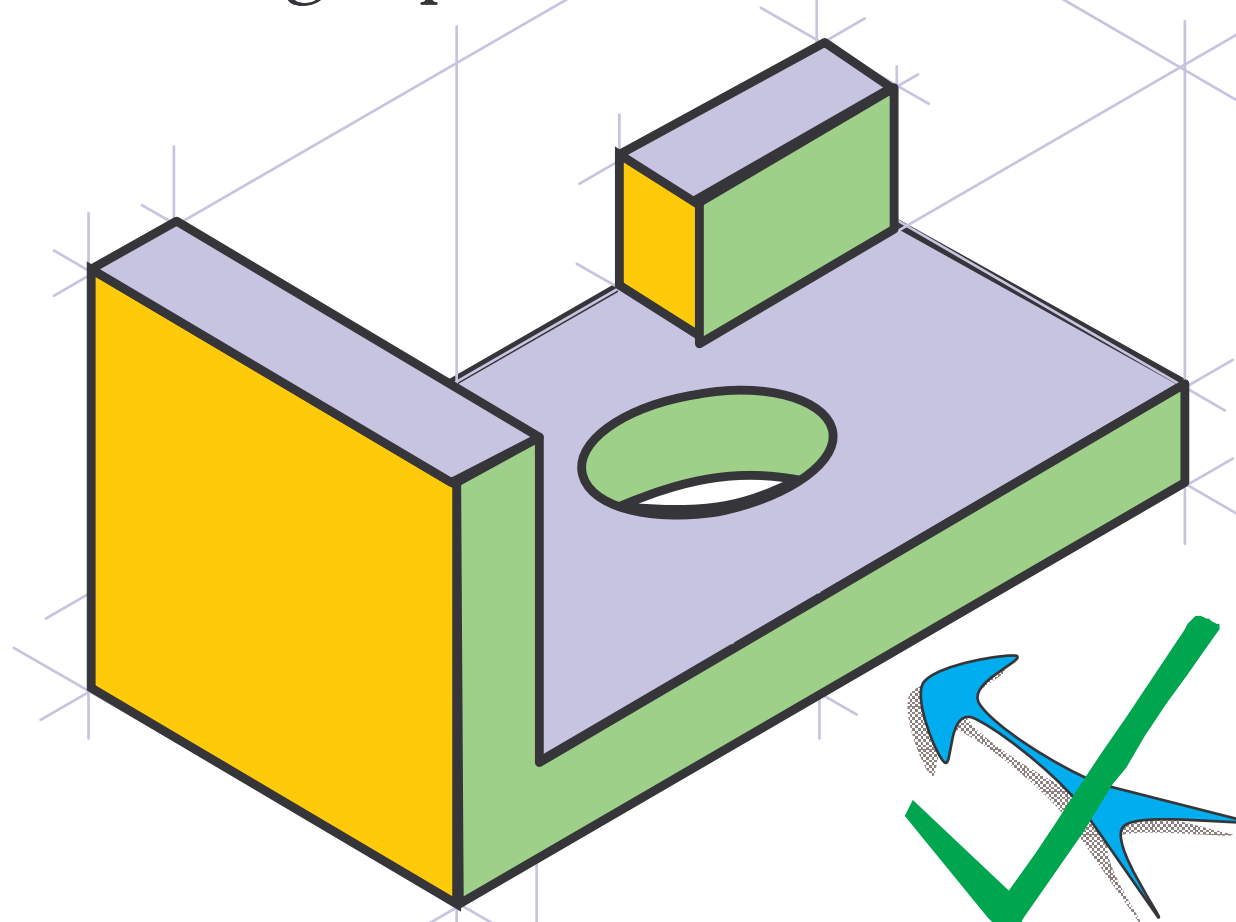

SIMPLE OBJECTS

- Bracket with high lip...

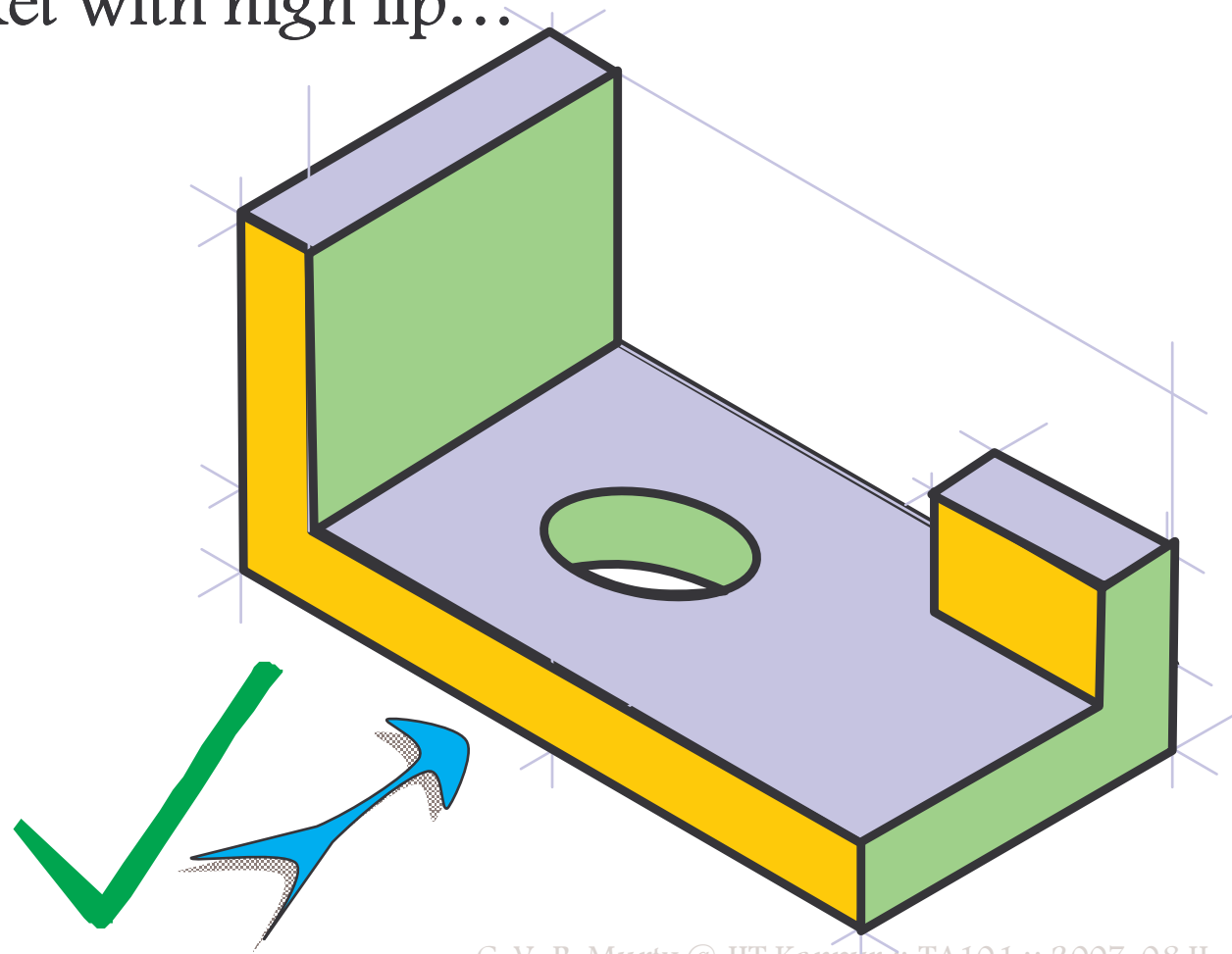

SIMPLE OBJECTS

- Bracket with high lip...

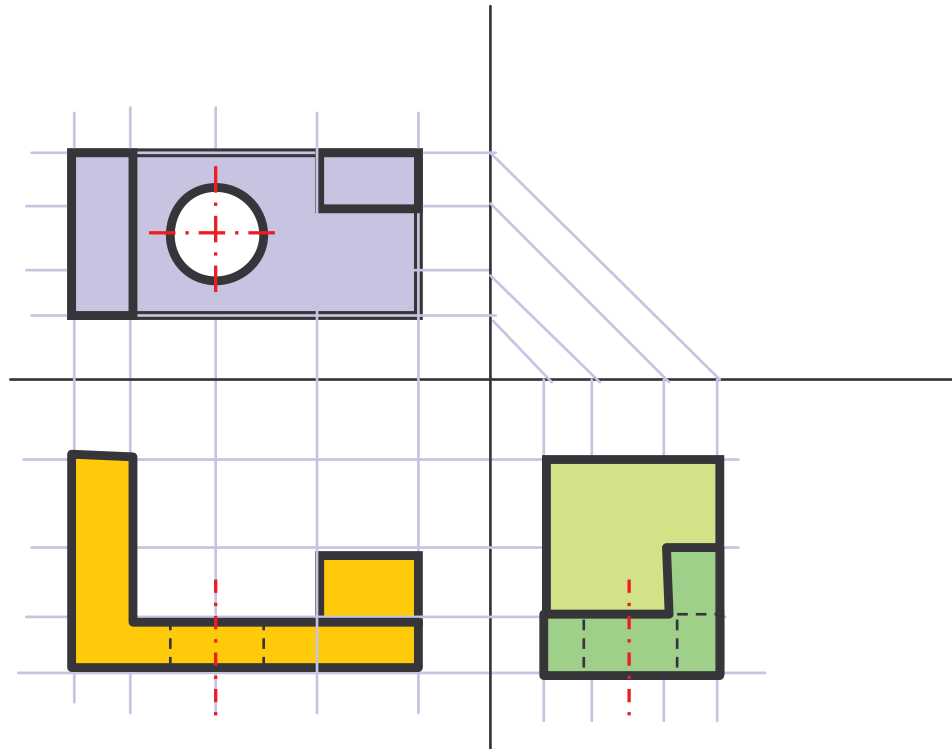
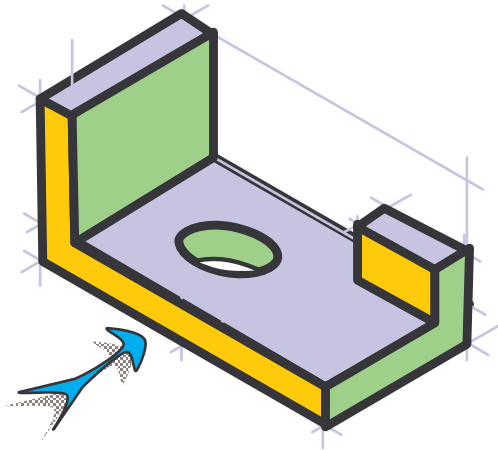

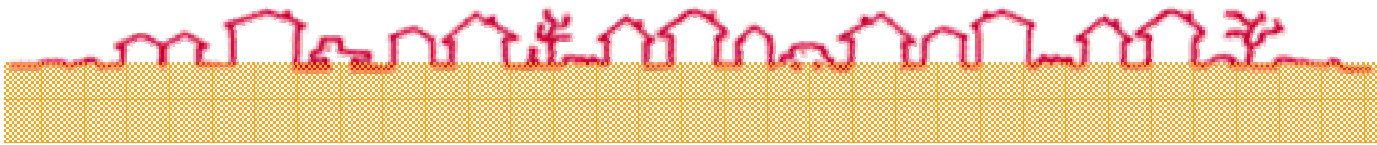

Have a Great Day!!